

Архангельск (8182)63-90-72
Астана (7172)727-132
Астрахань (8512)99-46-04
Барнаул (3852)73-04-60
Белгород (4722)40-23-64
Брянск (4832)59-03-52
Владивосток (423)249-28-31
Волгоград (844)278-03-48
Вологда (8172)26-41-59
Воронеж (473)204-51-73
Екатеринбург (343)384-55-89
Иваново (4932)77-34-06

Ижевск (3412)26-03-58
Иркутск (395)279-98-46
Казань (843)206-01-48
Калининград (4012)72-03-81
Калуга (4842)92-23-67
Кемерово (3842)65-04-62
Киров (8332)68-02-04
Краснодар (861)203-40-90
Красноярск (391)204-63-61
Курск (4712)77-13-04
Липецк (4742)52-20-81
Киргизия (996)312-96-26-47

Магнитогорск (3519)55-03-13
Москва (495)268-04-70
Мурманск (8152)59-64-93
Набережные Челны (8552)20-53-41
Нижний Новгород (831)429-08-12
Новокузнецк (3843)20-46-81
Новосибирск (383)227-86-73
Омск (3812)21-46-40
Орел (4862)44-53-42
Оренбург (3532)37-68-04
Пенза (8412)22-31-16
Казахстан (772)734-952-31

Пермь (342)205-81-47
Ростов-на-Дону (863)308-18-15
Рязань (4912)46-61-64
Самара (846)206-03-16
Санкт-Петербург (812)309-46-40
Саратов (845)249-38-78
Севастополь (8692)22-31-93
Симферополь (3652)67-13-56
Смоленск (4812)29-41-54
Сочи (862)225-72-31
Ставрополь (8652)20-65-13
Таджикистан (992)427-82-92-69

Сургут (3462)77-98-35
Тверь (4822)63-31-35
Томск (3822)98-41-53
Тула (4872)74-02-29
Тюмень (3452)66-21-18
Ульяновск (8422)24-23-59
Уфа (347)229-48-12
Хабаровск (4212)92-98-04
Челябинск (351)202-03-61
Череповец (8202)49-02-64
Ярославль (4852)69-52-93

<https://tsi.nt-rt.ru> || tfs@nt-rt.ru

КАТАЛОГ

COPLEY

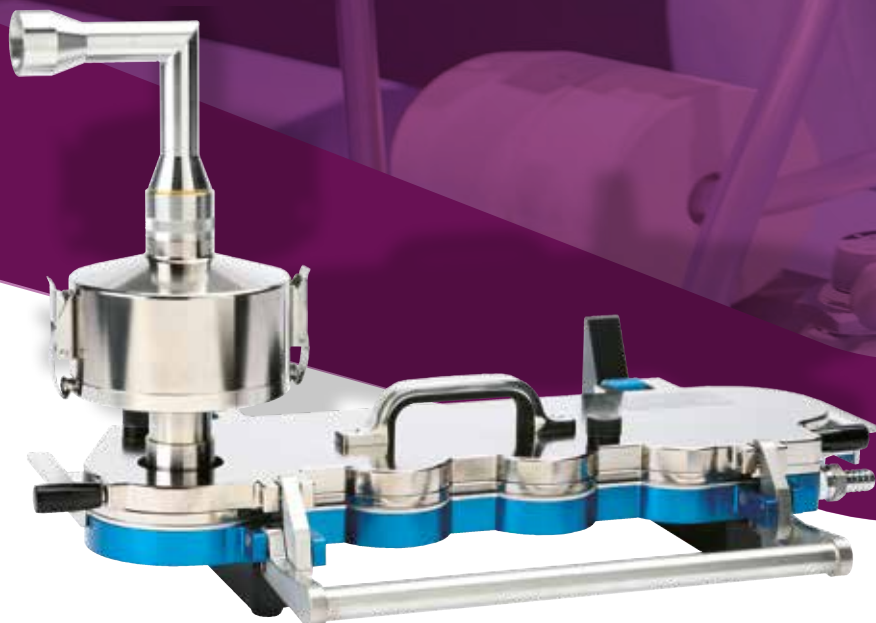

Driving Results in Inhaler Testing

METERED-DOSE INHALERS • DRY POWDER INHALERS
NEBULISERS • NASAL SPRAYS

2020 EDITION

About Us

Copley: Driving Results for Over 70 Years

Founded in 1946 in Nottingham, UK, Copley remains family owned and managed. We are recognised as the world's leading manufacturer of inhaler test equipment, in addition to being a trusted provider of test instrumentation for other pharmaceutical dosage forms.

We continue to work closely with industry groups and leading experts to bring relevant new products to market, with all equipment backed by expert training and lifetime support.

Committed to excellence, we aim to deliver exemplary service for an outstanding customer experience.

We deliver pharmaceutical testing equipment with the necessary accuracy and reproducibility hard-wired into its design by adopting the same Quality by Design (QbD) principles that our customers rely on to control product performance. Continuous improvement is a core element of this approach and we strive to exceed the expectations of the industry, not only by enhancing equipment performance but also through unrivalled service.

These commitments are exemplified by our investment in the **ISO 9001:2015 Quality Management System** for which we have certification to the latest standard for all aspects of our business, including equipment design.

Copley customers benefit from:

- High quality pharmaceutical testing equipment, designed, manufactured and tested in the UK
- Product lifetime support from our friendly and experienced technical support team
- First-class training and education

Copyright

This edition of the Copley Scientific Limited brochure is copyright 2020. All rights reserved.

No portion of this brochure may be reproduced without the permission of Copley Scientific Limited. Copley Scientific Limited reserves the right to make changes without notice to any products herein to improve reliability or design.

Copley Scientific Limited does not assume any liability arising out of the application or use of any product described herein. Neither does it convey any licence under its patent rights nor the rights of others.

Any third party documentation or organisation mentioned herein is referential only and implies no company or product endorsement from, or affiliation with, Copley Scientific Limited.



The Copley Promise



- ✓ **Innovative**
Innovative product design features ensure ease-of-use and maximum productivity by streamlining work flows.
- ✓ **Compliant**
Products are certified to quality standards defined by global pharmacopoeias and regulators, ensuring data integrity.
- ✓ **Trusted**
Robust design and manufacture from a company with over 70 years' experience guarantees product reliability and longevity.

Introduction	2	Device Safety, Quality and Efficacy (ISO)	18	Modified Configurations for use at 60 and 90 L/min	46
About Us	2	International Standards Organisation (ISO)	18	Quality	46
ISO 9001:2015 Quality Management System	2	Expert Groups	18	Materials of Construction	47
The Copley Promise	3			Ease of Use	47
Table of Contents	4	Pharmacopoeial Specification	19	Next Generation Impactor (NGI)	50
Equipment Selection Guide	6	Current Pharmacopoeial Specifications	19	Introduction	50
Inhaled Drug Products	7	Delivered Dose	19	Description	50
Introduction to Inhaled Drug Products	7	Aerodynamic Particle Size Distribution (APSD)	20	Procedure	52
Metered-Dose Inhalers (MDIs)	8	European Pharmacopoeia (Ph.Eur.)	20	Ancillaries	53
Breath-Actuated MDIs	8	United States Pharmacopeia (USP)	20	Multi-Stage Liquid Impinger (MSLI)	54
Spacers	8	Chinese Pharmacopoeia (ChP)	20	Glass Twin Impinger (GTI)	55
Valved Holding Chambers (VHCs)	8			Impactors for testing: MDIs with Spacers and VHCs	56
Dry Powder Inhalers (DPIs)	9	Delivered Dose Uniformity	21	Nasal Delivery Systems	58
Passive (Pre-metered)	9	Introduction to Delivered Dose Uniformity (DDU)	21	Nebulisers	60
Passive (Device-metered)	9	EMA Guidelines	22	NGI Cooler	60
Active	9	Ph.Eur. Guidelines	22		
Aqueous Droplet Inhalers	9	FDA Guidelines	22	Abbreviated Impactor Measurement (AIM)	62
Nebulisers	10	USP Guidelines	23	Introduction	62
Jet	10	Dosage Unit Sampling Apparatus (DUSA) for MDIs	24	AIM in QC	63
Ultrasonic	10	Dosage Unit Sampling Apparatus (DUSA) for DPIs	28	AIM in R&D	64
Mesh	10	Waste Shot Collector (WSC2)	31	Fast Screening Andersen (FSA)	65
Nasal Delivery Systems	11	Delivered Dose Sampling Apparatus for Nebulisers with a Mouthpiece	32	Reduced NGI (rNGI)	66
Metered Spray Pump (Aqueous-based)	11	Delivered Dose Sampling Apparatus for Nebulisers with a Facemask	34	Fast Screening Impactor (FSI)	67
Powder-based Nasal Devices	11	Delivered Dose Sampling Apparatus for Spacers and VHCs with a Mouthpiece	36		
Propellant-based		Delivered Dose Sampling Apparatus for Spacers and VHCs with a Facemask	38	Improved In Vitro - In Vivo Correlation (IVIVC)	68
Nasal Aerosols (MDIs)	11			Introduction	68
Novel Nasal Devices	11			Breathing Simulators	69
				Alberta Idealised Throats (AIT)	70
				Mixing Inlet	72
Organisations and their Roles	12	Aerodynamic Particle Size	40		
Introduction to Organisations and their Roles	12	Introduction	40	Ancillaries	74
Organisational Chart	13	Cascade Impactors	41	Introduction to Ancillaries	74
Regulatory	13	Impactor Systems	41	Breathing Simulators	75
Drug Efficacy	13	Principles of Operation	42	Introduction	75
Device Efficacy	13	Choosing an Impactor or Impinger for MDIs and DPIs	43	Model BRS 1100	76
Expert Groups	13	Andersen Cascade Impactor (ACI)	43	Model BRS 2100	78
Regulatory Bodies	14	Next Generation Impactor (NGI)	44	Model BRS 3100	79
European Medicines Agency (EMA)	14	Multi-Stage Liquid Impinger (MSLI)	44	Critical Flow Control	80
Food and Drug Administration (FDA)	14	Other Impactors	44	Testing <i>In Vitro</i>	80
International Regulation and Harmonisation	15	Andersen Cascade Impactor (ACI)	45	Flow Rate	80
Drug Safety, Quality and Efficacy (the Pharmacopoeias)	16	Impactor Use (MDIs)	45	Inspiration Volumes	81
European Pharmacopoeia (Ph.Eur.)	16	Impactor Use (DPIs)	45	Critical (Sonic) Flow	81
United States Pharmacopeia (USP)	16			Critical Flow Controller Model TPK/-R	82
Chinese Pharmacopoeia (ChP)	16			Critical Flow Controller Model TPK 2100/-R	84
				Breath Actuation Controller Model BAC 2100/-R	86

Flow Meters	88	Automation	113	Analytical Errors	133
Introduction	88	Introduction to Automation	113	Instrument-Related Errors	133
Flow Meter Model DFM4	89	Labour Saving Tools - Delivered Dose Uniformity	114	Impactor Qualification (AIQ)	134
Flow Meter Model DFM 2000	89	DUSA Shaker	114	Pharmacopoeial Criteria	134
Mouthpiece Adapters	90	Labour Saving Tools - Cup Coating (NGI)	116	Stage Mensuration	135
Vacuum Pumps	91	NGI Cup Coater	116	Mensuration	135
Introduction	91	Labour Saving Tools - Sample Preparation (ACI & NGI)	118	Cleaning	136
Low Capacity Pump LCP5	92	Gentle Rocker	118	Interpretation of Data	136
High Capacity Pump HCP5	92	Sample Preparation Unit SPU 2000	120	Restoring Performance	137
Super Capacity Pump SCP5	93	Labour Saving Tools - Impactor Cleaning (ACI & NGI)	122	Qualification Documentation	138
Data Analysis Software		Impactor Cleaning System	122	IQ/OQ Documentation	138
CITDAS	94	Semi-Automation - Automated Shake, Fire & Flow Control for MDIs	124	Qualification Tools	139
Sundries	100	Vertus II	124	Leak Testing	139
Spare Tubing	100	Vertus Plus	126	System Testing Qualification Kit	139
Quick-Release Connectors	100	Automated Nasal Spray Testing System	127	Impactor Performance	139
Device Resistance Measurement	100	DecaVertus II	128	Electrostatic Effects	140
Rinsing Caps	100	Semi-Automation - Next Generation Impactor (NGI)	130	Qualification Services	140
Special Applications	101	NGI Assistant	130		
Introduction	101	Qualification	132	Design/Service/Training	141
Dissolution Testing	102	Introduction to Qualification	132	Design	141
Inhaled Dissolution Filter Holder	105	Impactor Testing - Possible Sources of Error	133	Service	141
NGI Dissolution				Training	142
NGI and ACI Membrane Holders for Dissolution Testing	105				
Generic Drug Development	106			Index	144
FP/Salmeterol	107			Notes	147
Albuterol	109				
Spray Force Tester Model SFT	111				
1000 Plume Temperature Tester Model PTT 1000	111				



Equipment Selection Guide

	Metered-Dose Inhaler (MDI)*	Dry Powder Inhaler (DPI)	Nebuliser**	Nasal Spray (Aqueous)
Description of Drug Delivery Device	Page 8	Page 9	Page 10	Page 11
Delivered Dose Uniformity (DDU)	DUSA for MDIs (Page 24) Mouthpiece Adapter (Page 90) Vacuum Pump (Page 91) Flow Meter (Page 88) Waste Shot Collector (Page 31) Breath Actuation Controller (Page 86) - Option	DUSA for DPIs (Page 28) Mouthpiece Adapter (Page 90) Vacuum Pump (Page 91) Critical Flow Controller (Page 80) Flow Meter (Page 88) Waste Shot Collector (Page 31)	Filter Holder & Adapter (Page 32) Mouthpiece Adapter (Page 90) Breathing Simulator (Page 75)	N/A (Direct into Vial/Flask)
Aerodynamic Particle Size (APSD)	Cascade Impactor: ACI (Page 45) NGI (Page 50) MSLI (Page 54) GTI (Page 55) Mouthpiece Adapter (Page 90) Induction Port (Page 49/53) Vacuum Pump (Page 91) Flow Meter (Page 88)	Cascade Impactor: ACI + Preseparator (Page 46) NGI + Preseparator (Page 52) MSLI (Page 54) GTI (Page 55) Mouthpiece Adapter (Page 90) Induction Port (Page 49/53) Critical Flow Controller (Page 80) Vacuum Pump (Page 91) Flow Meter (Page 88)	NGI + Internal Filter Holder (Page 52) NGI Cooler (Page 60) Mouthpiece Adapter (Page 90) Induction Port (Page 53) Critical Flow Controller (Page 80) Vacuum Pump (Page 91) Flow Meter (Page 88)	Cascade Impactor: ACI (Page 45) NGI (Page 50) Expansion Chamber (Page 59) Nosepiece Adapter (Page 59) Vacuum Pump (Page 91) Flow Meter (Page 88)
APSD Data Analysis	CITDAS (Page 94)			-
DDU Automation	DUSA Shaker (Page 114)		-	-
APSD Automation	Next Generation Impactor (Pages 116-131)		Andersen Cascade Impactor (Page 120-121)	
Mensuration Services (Calibration)	Mensuration Services (Page 135-137)			
Qualification	Introduction (132)	IQ / OQ Qualification Documentation and Tools (Page 138)		
Design / Servicing Training	Design / Servicing / Training (Page 141)			

* For MDIs with spacers/VHCs see pages 36 and 56 ** For nebulisers with facemasks see pages 34 and 61

Inhaled Drug Products

Introduction

The devices used for inhaled and nasal drug delivery are collectively referred to as orally inhaled and nasal drug products (OINDPs).

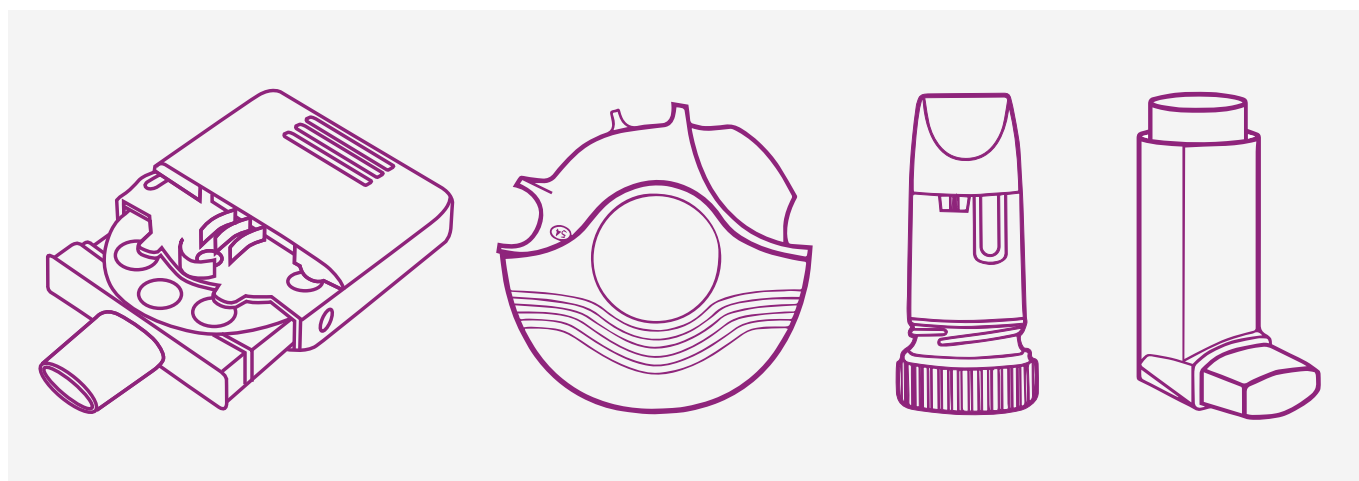

The range of products available is broad, encompassing inhalers (metered-dose, dry powder and aqueous droplet), nebulisers (jet, ultrasonic and vibrating mesh) and nasal sprays (aqueous based, dry powder and propellant based).

Pressurised metered-dose inhalers (pMDIs or simply MDIs) use a propellant to deliver a fixed volume of liquid solution or suspension to the patient in the form of an aerosol. They are small, inexpensive, convenient for the user and suitable for a wide range of drugs. At the same time, the use of MDIs requires good coordination and technique, and the actuation force needed means they are not always suitable for elderly or paediatric users. Spacers (or valved holding chambers) and newer breath-actuated MDIs can help resolve these problems.

Dry Powder Inhalers (DPIs) are an attractive option to an industry well used to powder formulations. Typically, the active drug is mixed with an excipient containing much

larger particles, for example lactose, to which it attaches. During aerosolisation the active is stripped from the carrier and inhaled whilst the carrier particles impact on the mouth and throat and are ingested. DPIs synchronise drug delivery with inhalation.

However, their relatively high cost and reliance on inhalation strength and duration are potential drawbacks.

Aqueous droplet inhalers are a new generation of devices that deliver a pre-metered dose of liquid formulation without using a propellant. They actively aerosolise the liquid, producing a “soft mist” of fine particles. These inhalers generally deliver a higher fine particle fraction to the lungs than MDIs or DPIs. As with any multi-dose liquid system, microbial contamination can be a problem.

Nebulisers, like aqueous droplet inhalers, actively aerosolise a liquid formulation. Nebulisers, however, normally operate

continuously once loaded. They are widely used at home and in hospital and demand little or no coordination for effective use. The disadvantage is that they tend to be cumbersome and require either compressed air or an electrical supply. Newer vibrating mesh technology is an improvement, delivering portable, silent, battery-operated devices.

Historically used to treat allergic or seasonal rhinitis, there is now increasing interest in the use of **Nasal Sprays** for systemic drug delivery. Like inhalers, nasal sprays can be liquid or powder based. Aqueous systems can be manually actuated or propellant driven. They are commonly multi-dose although unit dose devices are popular for delivering vaccines and pain relief.

Drug Delivery Devices

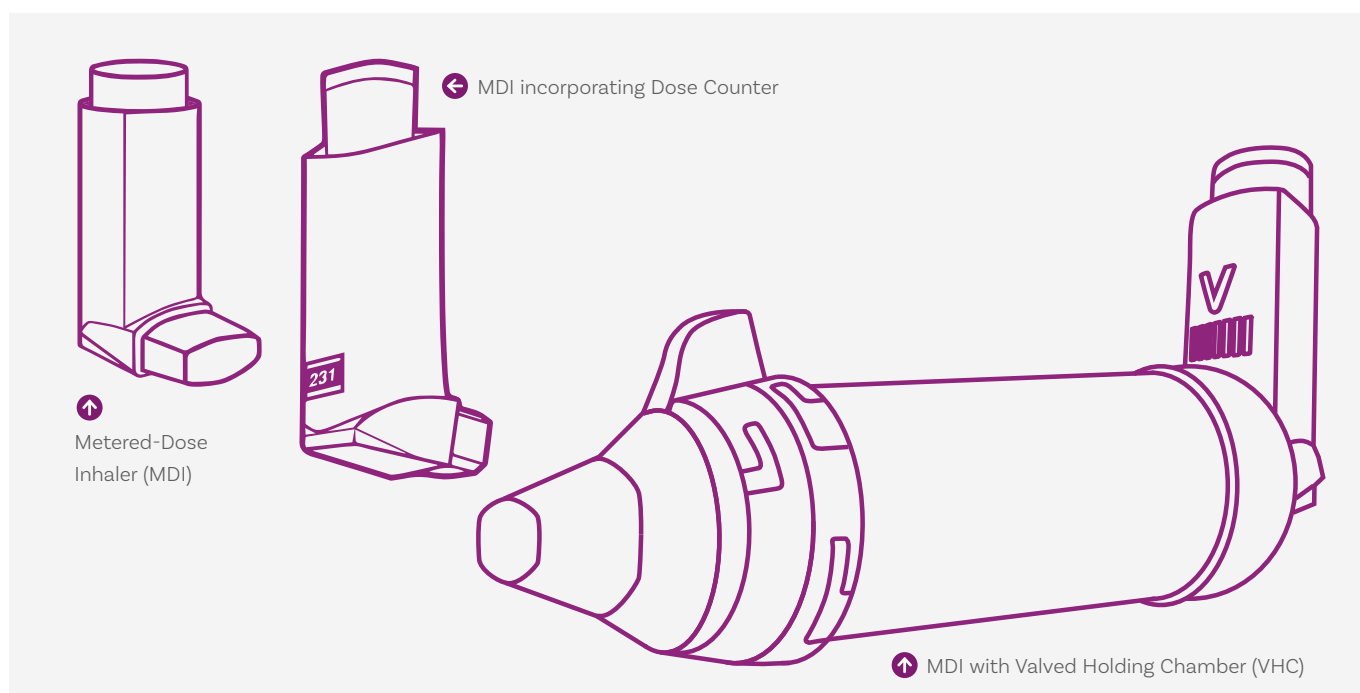

APPLICATIONS

Inhaled drug products are becoming increasingly popular as a means of delivering local or systemic therapy via the lungs or nasal mucosa.

Inhalation therapy has been in use for a number of years:

- a) **Locally** (directly) to treat lung diseases such as asthma and chronic obstructive pulmonary disease (COPD), and to deliver locally acting drugs such as antibiotics and antivirals directly to the lungs to curb infection, and
- b) **Systemically** (absorption), for example in pain relief and anaesthetic applications

Pulmonary delivery offers a number of advantages compared to the more traditional oral and parenteral (subcutaneous injection) routes:

- Directly targets the lungs
- Rapid onset of drug action
- Drugs effective in relatively low doses
- Fewer side effects
- Avoids hepatic metabolism
- Injection-free administration

More recently, considerable research and development has been devoted to delivering new drugs into the systemic circulation via the inhaled route – no doubt attracted by the large surface area and easy air/blood interface provided by the respiratory system.

Such drugs include treatments for diverse applications such as diabetes, erectile dysfunction, migraine, osteoporosis and for vaccine delivery.

DRUG DELIVERY DEVICES

Collectively described as **orally inhaled and nasal drug products (OINDPs)**, these can be divided into the following categories:

1. Metered-Dose Inhalers (MDIs)

Whilst there are non-pressurised MDIs on the market, this term is normally reserved to describe the pressurised version of the inhaler (MDI) so familiar to people with asthma.

The MDI comprises a pressurised canister containing the medication and propellant, together with a delivery device – normally a metering valve linked to an actuator. Pressing down on the canister releases the drug in the form of an aerosol cloud – this is then inhaled into the lungs.

The MDI is convenient, rugged and cheap to manufacture. It works well with the bronchodilators and corticosteroids traditionally used to treat respiratory disorders because of the potency and wide therapeutic window of the drugs concerned.

Comparatively recent developments have seen the replacement of the traditional CFC (chlorofluorocarbon) propellants with more ozone friendly and efficient alternatives in the form of hydrofluoroalkane (HFA) propellants, and the incorporation of dose counters into the MDI.

Patient coordination of actuation with inhalation can be a problem with MDIs, particularly in the young, old or chronically ill.

Breath-Actuated MDIs seek to overcome this problem by sensing the patient's inhalation through the actuator and synchronising dose delivery with it.

Other methods of overcoming this problem include **Add-on Devices** such as **Spacers** and **Valved Holding Chambers (VHCs)** which reduce or eliminate the need for coordination between actuation and inhalation together with the cold Freon® effect (see Page 111) that is often the cause of the problem.

2. Dry Powder Inhalers (DPIs)

Historically, the DPI was limited to single dose capsule systems and the inhaler market was dominated by the chlorofluorocarbon (CFC) propelled MDI.

When, in 1997, the Montreal Protocol effectively banned the ozone depleting CFCs, the pharmaceutical industry was faced with the option of:

- a) Finding an alternative propellant (as in the HFA propelled MDI), or
- b) Developing new ways of delivering drug to the lungs

It is the latter that provided a resurgence of interest in the DPI. As the name suggests, in the DPI the medication comes in the form of a dry powder.

The majority of DPIs are **passive** devices, that is to say they rely on the patient's inspiration to operate. There is no need to coordinate breathing with the actuation - the patient simply inhales deeply to access the drug.

The passive DPI can be sub-divided into two categories:

- a) **Pre-metered** (single or multi-dose) where the dose is pre-measured during manufacture as, for example, blisters, capsules or similar cavities

- b) **Device-metered** where the drug is contained in a reservoir within the device which pre-measures each dose on actuation

Some DPIs actively generate the aerosol, reducing the dependence on patient inhalation, whilst simultaneously improving the accuracy and reproducibility of the delivered dose.

Such devices are normally termed **active** DPIs and are particularly useful where the patient's own inspiration capability is compromised. Assistance normally comes in the form of pressurised/compressed air or through vibrations generated by a piezoelectric transducer.

3. Aqueous Droplet Inhalers (Solution Metering Inhalers)

Both MDIs and DPIs suffer from the same two inherent problems: low lung deposits (typically 5-20%) and dose variability (often due to patient difficulties in coordination or inspiration).

Aqueous Droplet Inhalers (often known as **"Solution Metering"** or **"Soft Mist"** Inhalers), are a new generation of inhaler designed to overcome these problems.

The Aqueous Droplet Inhaler is effectively a propellant-free Metered-Dose Liquid

Inhaler (MDLI) sharing the following common characteristics:

- Precision-dosed liquid-based metering (normally water or ethanol)
- "Active" aerosol generation (mechanical or electromechanical)
- Patient-independent, accurate and reproducible dosing
- High fine particle fraction
- Requirement for sterile production and addition of bacteriostatic agents to prevent microbial contamination in the case of multi-dose solution reservoirs

Methods of aerosol generation include:

- (a) Forcing liquid through nozzles
- (b) Electro spraying
- (c) Thermal generation and
- (d) Vibration mesh

As far as testing is concerned, most Aqueous Droplet Inhalers are treated as MDIs unless their particular design dictates otherwise.

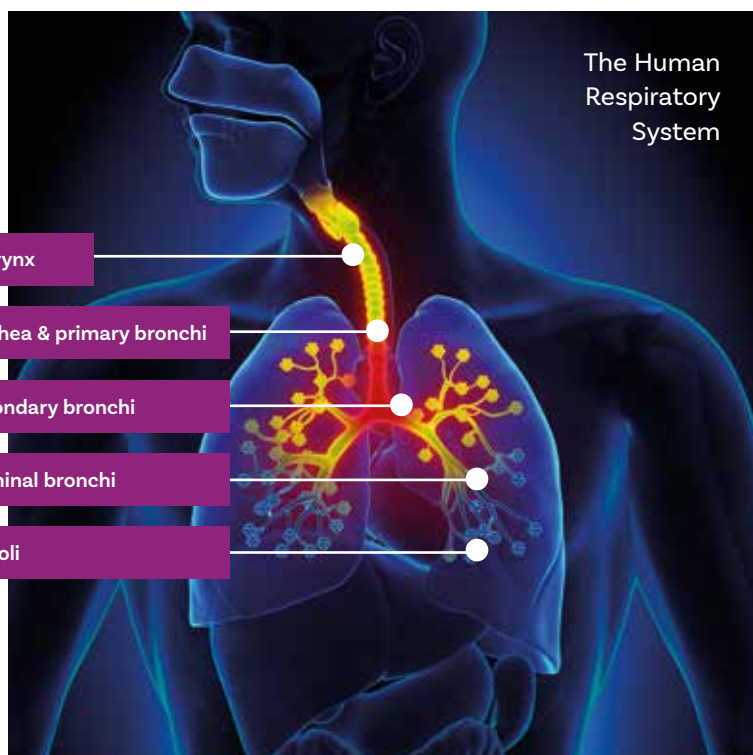
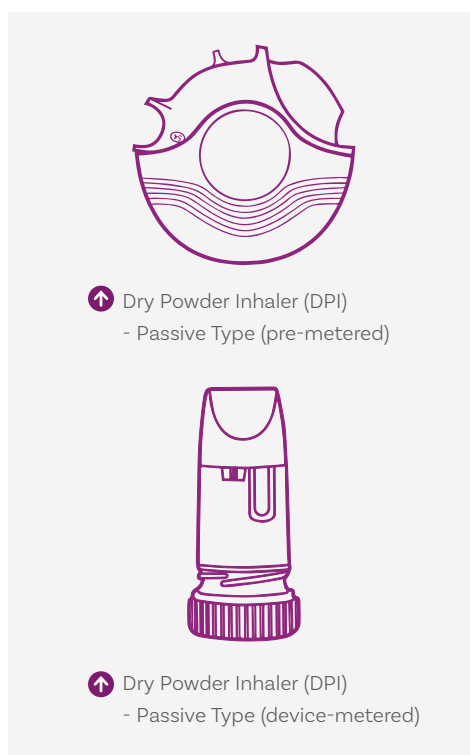

Drug Delivery Devices

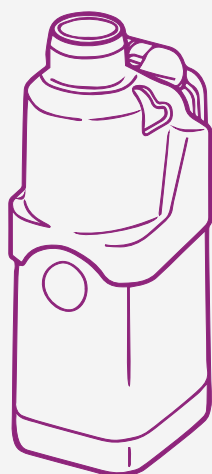

↑ Ultrasonic Nebuliser

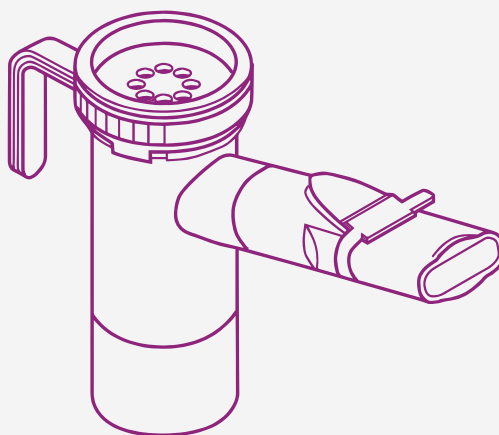

↑ Jet Nebuliser

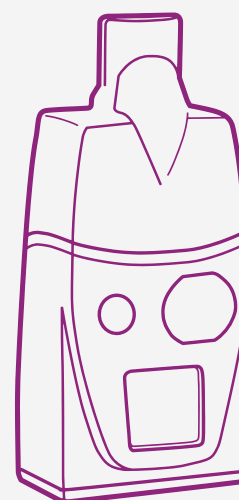

↑ Mesh Nebuliser

4. Nebulisers

A nebuliser may be defined as a device that can convert a liquid into aerosol droplets to produce a respirable cloud suitable for inhalation.

Normally it must be loaded with the drug before each treatment. Once activated it operates on a continuous basis. It should not be confused with the Aqueous Droplet Inhaler described in the preceding section which delivers a **pre-metered dose** or bolus of medication.

This difference is important since the regulatory bodies traditionally classified nebulisers as medical equipment. This led them to be regulated differently, and hitherto less stringently, than the other drug delivery devices described in this brochure, which are classified as pharmaceuticals. However, this is changing and nebulisers are now considered “combination” products.

Conventional nebulisers are widely used in both hospital and home. Their main advantage is that unlike other devices, they require little or no coordination on the part of the patient in order to use them.

Their disadvantages include their size and weight (a compressed air or electrical supply is normally required for operation), expense, inefficiency and inter-brand variability.

Conventional nebulisers fall into two categories, namely, **Jet** and **Ultrasonic**.

More recent years have seen the introduction of a new wave of more portable nebulisers based on **Mesh** technology.

a) Jet Nebulisers

Jet Nebulisers use a compressed air supply to atomise liquid drug to produce a fine mist using the Bernoulli principle.

The Jet Nebuliser itself can be sub-divided into three types depending on their output during exhalation:

- **Standard** – constant output throughout the respiratory cycle
- **Breath-Enhanced** – constant output but provides higher output during inhalation
- **Breath-Actuated** – aerosol produced only during inhalation

b) Ultrasonic Nebulisers

Ultrasonic Nebulisers use electricity to vibrate a piezoelectric crystal at high frequency.

The resultant vibrations are transmitted to a reservoir containing the liquid drug, creating a series of waves from which liquid droplets separate to form an aerosol.

c) Mesh Nebulisers

A new generation of portable, efficient, silent, battery-operated nebulisers has been developed based on vibrating mesh technology.

Mesh nebulisers use the ultrasonic principle to generate droplets which are then pushed through a static or vibrating mesh or plate (either electro-formed or laser drilled) to form a cloud prior to inhalation.

Some mesh nebulisers incorporate sensing devices to detect the patient's inspiration in order to provide **breath enhanced**, **breath activated** or **breath integrated** systems.

Drug Delivery Devices

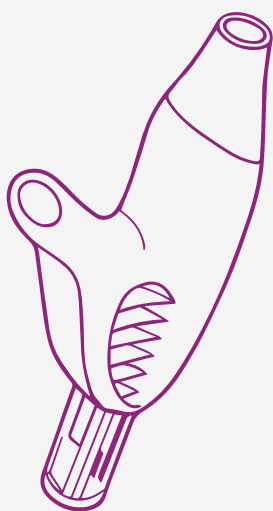

↑ Powder-based Nasal Device



↑ Metered Nasal Spray Pump

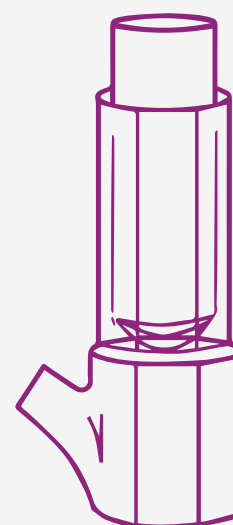

↑ Propellant-based Nasal Aerosol

5. Nasal Delivery Systems

Traditionally, nasal preparations have been used for the local administration of anti-histamines, decongestants and steroids in order to alleviate cold or allergy symptoms and nasal congestion.

More recently attention has focused on two other areas:

- The potential rapid drug absorption into the **systemic circulation** provided by the turbinates and lymphoid tissues located at the back of the nasal cavity. This is already in use in a number of areas, e.g. migraine and pain relief, osteoporosis, vaccines and
- The potential of the “Nose to Brain” entry to the **central nervous system** presented by the olfactory region at the top of the nasal cavity for the treatment, for example, of diseases of aging such as Alzheimers Disease

Conventional nasal technologies fall into three main categories:

- Metered spray pumps (aqueous-based)
- Powder-based nasal devices
- Propellant-based nasal aerosols (MDIs)

a) Metered Spray Pumps (Aqueous-based)

Mechanical metered-dose spray pumps have largely replaced droppers and squeeze bottles as the drug delivery device of choice because of the latter’s inability to deliver an accurate and consistent dose.

Hitherto, **multi-dose** spray pumps have dominated the nasal market and are widely available through a number of device manufacturers.

Unit-dose devices that deliver one or two shots (one per nostril), usually based on the syringe principle, are also becoming increasingly popular for delivering certain drugs, e.g. pain relief and vaccines.

Where drugs are formulated as aqueous solutions or suspensions then undesirable preservatives are normally added to prevent microbiological contamination. This problem can also be addressed by using unit-dose devices.

b) Powder-based Nasal Devices

Available in both multi- and unit-dose formats, powder-based devices provide another solution to preservative-free delivery and can produce longer nasal retention times than liquids.

Powder-based nasal sprays are ideal for peptides, hormones and antigens (more stable) and where high dose concentrations are required and can be produced using conventional manufacturing techniques.

c) Propellant-based Nasal Aerosols (MDIs)

Pressurised metered-dose inhaler (MDI) technology provides another method of delivering drug to the nasal mucosa. Similar to a regular MDI for oral use, a propellant-based nasal aerosol usually features a nosepiece (nozzle) designed at an angle for insertion into the nostril.

d) Novel Nasal Devices

Two examples of novel nasal drug delivery systems receiving attention are (a) a bi-directional nasal device which uses the body’s natural reaction to close the soft palate whilst exhaling to prevent lung deposition and (b) a nebuliser using ampoules employing “controlled particle dispersion” to dispense the drug.

Organisations and their Roles

Introduction

The ultimate responsibility for the safety, quality and efficacy of medicines and medical devices lies with the various national regulatory bodies designated to safeguard public health.

In Europe and in the USA this function is performed by the **European Medicines Agency (EMA)** and by the **Food and Drug Administration (FDA)** respectively.

The regulatory authorities are supported in this role by:

- a) The **Pharmacopoeias** whose job is to define the standards with which the drug formulation shall comply and the methods by which compliance will be adjudged, and
- b) In the case of OINDPs, by the **International Standards Organisation (ISO)** whose function is to define the standards and methods relating to the medical device, e.g. inhaler, nebuliser, etc., concerned

In 2002 the FDA launched a new initiative “Pharmaceutical cGMPs for the 21st Century” in which it proposed a new risk-based approach to pharmaceutical manufacturing.

This initiative gave birth to **Process Analytical Technology (PAT)**, a framework for understanding and improving the processes involved in Pharmaceutical Development, Manufacturing and Quality Control, described

in the FDA’s Guidance of September 2004.

PAT operates on the premise that quality cannot be tested into products, rather, it should be built-in or should be by design.

The goal is to ensure final product quality by understanding and controlling the processes involved in the manufacturing operation.

The **Quality by Design (QbD)** approach was agreed and recommended for adoption by the EMA, FDA and the Japanese MHLW in the form of the five quality related guidelines, ICH Q8, Q9, Q10, Q11 and Q12 published by the **International Conference on Harmonisation of Technical Requirements for Registration of Pharmaceuticals for Human Use (ICH)**, extends this philosophy to all parts of the product cycle from product development, transfer through to manufacturing, manufacturing and finally product end.

ICH Q8 Pharmaceutical Development describes the suggested contents of a regulatory submission based on the QbD format.

ICH Q9 details a systematic approach to quality risk management whilst ICH Q10 describes a new quality management system

based on the complete product lifecycle and referred to as the Pharmaceutical Quality System.

ICH Q11 provides a Guideline to the “Development and Manufacture of Drug Substances” including the type and extent of information to be submitted in regulatory dossiers.

Finally, ICH Q12 (public consultation stage) is intended to work with ICH Q8-Q11 guidelines to provide a framework to facilitate the management of the entire “Pharmaceutical Product Lifecycle” focusing particularly on the Commercial Manufacturing phase.

Organisational Chart: Guidelines and Regulations

	Metered-Dose Inhaler (MDI)*	Dry Powder Inhaler (DPI)	Aqueous Droplet Inhaler	Nasal Spray (Aqueous)	Nebuliser
Regulatory					
EMA Guidelines	Guideline on the Pharmaceutical Quality of Inhalation and Nasal Products (2006)				
	Guideline on the Requirements for Clinical Documentation for Orally Inhaled Products (OIP) including the Requirements for Demonstration of Therapeutic Equivalence between Two Inhaled Products for use in the Treatment of Asthma and Chronic Obstructive Pulmonary Disease (COPD) in Adults and for use in the Treatment of Asthma in Children and Adolescents (2009)				
FDA Draft Guidance for Industry	Metered-Dose Inhaler (MDI) & Dry Powder Inhaler (DPI) Products (2018) - Quality Considerations				
				Nasal Aerosols and Nasal Sprays for Local Action (2003)	
FDA Guidance for Industry				Nasal Spray, Inhalation Solution, Suspension & Spray Drug Products (2002)	
Drug Efficacy					
European Pharmacopoeia 2017 (9th Edition)	Preparations for Inhalations (Dosage Forms 0671) Aerodynamic Assessment of Fine Particles (Chapter 2.9.18)			Nasal Preparations (Dosage Forms 0676)	Preparations for Nebulisation (Chapter 2.9.44)
US Pharmacopoeia 2018 (USP 41)	Inhalation & Nasal Drug Products - General Information & Product Quality Tests <5> Aerosols, Nasal Sprays, Metered-Dose Inhalers and Dry Powder Inhalers <601> Uniformity of Dosage Units <905> Pharmaceutical Dosage Forms (Aerosols - Inhalations) <1151>				Products for Nebulization <1601>
	Spacers & VHCs <1602>				
Chinese Pharmacopoeia 2015	Inhalation Products - Metered-Dose, Dry Powder Inhalers and Nebulisers - Delivered Dose Uniformity <0111> Aerodynamic Particle Size Distribution (APSD) <0951>				
Device Efficacy					
International Standards Organisation	Aerosol Drug Delivery Devices - Requirements and test methods (ISO 20072: 2013)				Nebulizing Systems (ISO 27427: 2013)
Expert Groups					
European Pharmaceutical Aerosol Group (EPAG)	<p>EPAG</p> <p>European based industry expert group involved in orally inhaled and nasal drug products</p>				
International Pharmaceutical Consortium on Regulation & Science (IPAC-RS)	<p>IPAC-RS</p> <p>US based industry expert group involved in orally inhaled and nasal drug products</p>				
Product Quality Research Institute (PQRI)	<p>PQRI</p> <p>A collaborative research organisation involving FDA's CDER, industry and academia</p>				

Organisations Involved in OINDPs

1. REGULATORY BODIES IN CHINA, THE EUROPEAN UNION, JAPAN AND USA

At present, there are no worldwide standards that are specifically applicable to OINDPs.

In Europe, the ultimate responsibility for the regulation of medicines and medical devices lies with the **European Medicines Agency (EMA)** in the form of the Committee for Medicinal Products for Human Use (CHMP).

The EMA was set up in 1995 to harmonise the work of existing national regulatory bodies in Europe.

The main guidance from the EMA relating to OINDPs is contained in two guidelines:

- CPMP (2006), “Guideline on the Pharmaceutical Quality of Inhalation and Nasal Products”
- CPMP (2009), “Guideline on the requirements for clinical documentation for orally inhaled products (OIP) including the requirements for demonstration of therapeutic equivalence between two inhaled products for use in the treatment of asthma and chronic obstructive pulmonary disease (COPD) in adults and for use in the treatment of asthma in children and adolescents”

These guidelines give a comprehensive list of the parameters that are critical to the safety,

quality and efficacy of the final product dependent on the specific type of inhaled or nasal preparation concerned.

A similar regulatory function is provided by the **Chinese FDA (CFDA)** in China and the **Ministry of Health, Labour and Welfare (MHLW)** in Japan.

In the USA, the regulatory function is performed by the **Food and Drug Administration (FDA)** through two centers, the Center for **Drug Evaluation and Research (CDER)** in respect of medicines and the Center for **Devices and Radiologic Health (CDRH)** in respect of medical devices.

The relevant current thinking from the FDA is reflected in the following regulatory Guidelines for industry:

- CDER (1998), “Metered-Dose Inhaler (MDI) and Dry Powder Inhaler (DPI) Drug Products”, Chemistry, Manufacturing and Controls Documentation – Draft
- CDER (2001), “Sterility Requirements for Aqueous-Based Drug Products for Oral Inhalation”, Small Entity Compliance
- CDER (2002), “Nasal Spray and Inhalation Solution, Suspension and Spray Drug Products”, Chemistry, Manufacturing and Controls Documentation

- CDER (2003), “Integration of dose-counting mechanisms into MDI products”, Clinical Medical

- CDER (2003), “Bioavailability and bioequivalence studies for nasal sprays for local action”, Biopharmaceutics – Draft

Since December 2013, the FDA has issued a series of product specific guidances relating to various active pharmaceutical ingredients including **Fluticasone Propionate, Salmeterol, Tiotropium, Albuterol, amongst others** intended to help generic manufacturers navigate the Abbreviated New Drug Application (ANDA) process (see Pages 106-110).

In April 2018, FDA published a new Draft Guidance for comment (Revision 1) entitled **“Metered Dose Inhaler (MDI) and Dry Powder Inhaler (DPI) Products - Quality Considerations”**.

This guidance which covers both quality and performance issues as well as CMC information is a revision of the previous 1998 Guidance “updated to reflect current standards and requirements to enhance understanding of appropriate development approaches for these products consistent with the quality by design (QbD) paradigm”.



ICI Quality Guidelines	
Q1A - Q1F Stability	Q7 - Good Manufacturing Practice
Q2 - Analytical Validation	Q8 - Pharmaceutical Development
Q3A - Q4B Impurities	Q9 - Quality Risk Management
Q4 - Q4B Pharmacopoeias	Q10 - Pharmaceutical Quality System
Q5A - Q5E Quality of Biotechnological Products	Q11 - Development and Manufacture of Drug Substances
Q6A - Q6B Specifications	Q12 - Lifecycle Management

Organisations Involved in OINDPs



2. INTERNATIONAL REGULATION AND HARMONISATION

The **International Conference on Harmonisation of Technical Requirements for Registration of Pharmaceuticals for Human Use (ICH)** is a unique organisation consisting of representatives from the regulatory authorities in the European Union (EMA), Japan (MHLW) and the USA (FDA), and experts from the pharmaceutical industry in the three regions, in a single forum.

The purpose of the ICH is to promote greater harmonisation in the way in which the individual regulatory bodies regulate new drugs such that the medicine reaches the patient economically and with the minimum delay whilst maintaining the standards of safety, quality and efficacy necessary to safeguard public health. (Note: A similar organisation, the **Global Harmonisation Task Force (GHTF) exists for medical devices**).

Whilst not OINDP specific, over the past few years, the ICH has concentrated on the preparation of four new quality related guidelines:

- ICH Q8(R2) Pharmaceutical Development
- ICH Q9 Quality Risk Management
- ICH Q10 Pharmaceutical Quality System
- ICH Q11 Development and Manufacture of Drug Substances

All of which have now been recommended for adoption by the regulatory authorities concerned (EMA, FDA and MHLW).

Collectively, these provide the guidelines for a new Pharmaceutical Quality System (PQS) described in ICH Q10. Based on International

Standards Organisation (ISO) quality concepts, the new system includes Good Manufacturing Practice (GMP) regulations where applicable and complements ICH Q8 and ICH Q9.

One of the key features of the new PQS is the decision to extend the system to include all parts of the product lifecycle, namely:

- Pharmaceutical Development
- Technology Transfer, e.g. from development to manufacturing
- Manufacturing and
- Product Discontinuation

This decision to extend the PQS to include Pharmaceutical Development through a concept known as **Quality by Design (QbD)** is described in more detail in ICH Q8(R2) Part II Pharmaceutical Development – Annex.

The ICH Q8(R2) Annex describes the principles and gives examples of many of the essential concepts employed in QbD including **Critical Quality Attributes (CQAs)**, Design Space and Control Strategy and its implementation through **Process Analytical Technology (PAT) Tools**.

ICH Q9 describes the principles of quality risk management and their application in a pharmaceutical environment.

ICH Q10 provides a model PQS covering the different stages of a product life cycle and thus a link between pharmaceutical development and manufacturing. As a guideline, ICH Q10 is not enforceable – however, it is likely that the regulators will consider it as standard best practice.

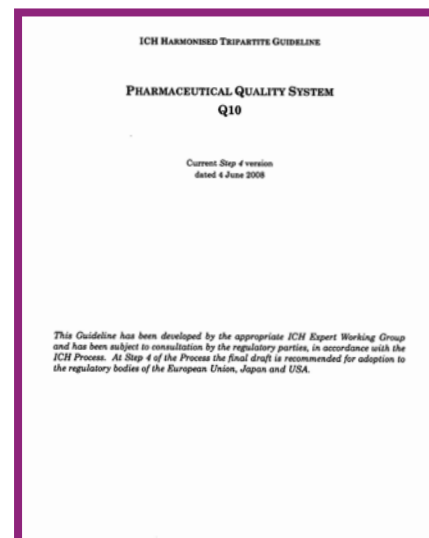

The practical implementation of the guidelines with respect to OINDPs is not easy because of (a) the complexities involved in manufacturing inhalation products, (b) the difficulties in applying real time test methods to them, and (c) the lack of clear *in vitro* – *in vivo* correlations (IVIVCs) for most formulations. This continues to be an area of considerable discussion in pharmaceutical development, quality and regulatory circles.

ICH Q11 provides a Guideline to the “Development and Manufacture of Drug Substances” including the type and extent of information to be submitted in regulatory dossiers.

Finally, mention should be made of ICH Q12 currently in public consultation stage but which when completed is intended to work with ICH Q8-Q11 guidelines to provide a framework to facilitate the management of the entire “Pharmaceutical Product Lifecycle”.

Organisations Involved in OINDPs

3. DRUG SAFETY, QUALITY AND EFFICACY – THE PHARMACOPOEIAS

The main role of the Pharmacopoeias is to define the standards with which medicines shall comply and the methods by which compliance will be adjudged.

As with the regulatory groups, the leading Pharmacopoeias tend to be those of China, the European Union, Japan and USA.

a) European Pharmacopoeia

In the **European Pharmacopoeia (Ph.Eur.)**, the initial information relating to the control of OINDPs is contained in the monograph associated with the dosage form concerned, e.g. Preparations for Inhalation (0671) with cross references to appropriate methods of testing, e.g. 2.9.18. Preparations for Inhalation: Aerodynamic Assessment of Fine Particles.

The Ph.Eur. is also responsible for **“Pharmeuropa”**, a bi-monthly publication available free online, which contains “Draft Monographs and General Texts for Comment” and “International Harmonisation”. This publication is a good indicator of new and/or amended monographs, e.g. - “Calibration and Mensuration Issues for the Standard and Modified ACI” Vol.12.4, p.584-588 (2000) - “2.9.44 Preparations for Nebulisation: Characterisation” Vol. 18.2, p.280-283 (2006).

b) United States Pharmacopoeia

Hitherto, the **United States Pharmacopoeia (USP)** has adopted a similar approach to Ph.Eur. but placed more emphasis on the Physical Tests and Determinations, e.g. Aerosols, Nasal Sprays, Metered-Dose Inhalers and Dry Powder Inhalers <601> than the type of dosage form, e.g. Pharmaceutical Dosage Forms <1151>.

However, in USP 38 the Pharmacopoeia introduced a series of new chapters, <1> through to <5>, which provide general information and the Critical Quality Attributes (CQAs) applicable to various dosage forms based on their route of administration.

The five chapters concerned detail the test procedures relevant to each dosage form, divided between those relating to product **quality** and those to product **performance**.

Product **quality** tests assess physical, chemical and microbial attributes. Product **performance** tests assess drug release from the dosage form concerned.

In the case of “Inhalation and Nasal Drug Products”, the quality tests are described in Chapter <5> whereas the performance tests are described in Chapter <601>.

Both Ph.Eur. 2.9.44 and USP <1601> now include chapters on tests designed to characterise those products used for nebulisation.

In addition, the USP has recently introduced a new Chapter <1602> to cover the testing of the **Spacers and Valved Holding Chambers** used with Inhalation Aerosols and are currently working on a new Chapter <1603> covering **Good Cascade Impactor Practice**.

The USP have also introduced a series of product-specific monographs

intended to assist the developers of generic inhaled drugs call for the clarification of the testing of such generics not hitherto specified in the general chapters (see Pages 106-110).

Like Ph.Eur., USP produce a bi-monthly publication which contains discussion documents relating to new and/or amended chapters and monographs. “Pharmacopoeial Forum” features items relating to “In-Process Revision”, “Harmonisation” and “Stimuli to the Revision Process.”

c) Chinese Pharmacopoeia

The **Chinese Pharmacopoeia (ChP)** has four chapters contained within its Volume IV applicable to OINDPs, <0111>, <0112>, <0113> and <0951>, plus five drug specific monographs.

Chapter <0111> relates to general requirements applicable to MDIs, DPIs and Nebulisers (incl. DDU) whilst <0951> describes those methods relating to Aerodynamic Particle Size Distribution (APSD) of OINDPs.

International Terminology for OINDPs

FDA / USP	EMA / Ph.Eur. / General
Inhalation Aerosol	(Pressurised) Metered Dose Inhaler
Inhalation Powder	Dry Powder Inhaler
Inhalation Spray	Aqueous Droplet Inhaler
Inhalation Solution	Nebuliser (Solution)
Inhalation Suspension	Nebuliser (Suspension)
Nasal Aerosol	Nasal Aerosol
Nasal Spray	Nasal Spray
Nasal Solution	-
Nasal Powder	Nasal Powder

In recent times the USP has sought to achieve closer harmonisation with the FDA, with regards to OINDPs, considering that its chapters and monographs should better reflect the primary market in which it serves, i.e. USA.

Moving closer to the FDA has had consequences for methods, specifications and also terminology and has also resulted in divergence from the Ph. Eur., with which it had previously sought to harmonise. For example, the USP has removed acceptance criteria for delivered dose uniformity (DDU) leaving this to the regulator.

The table to the right is a guide to the terminology now used to refer to the various types of OINDPs used by the FDA / USP and the EMA / Ph.Eur.

The terms referred to in this table are used interchangeably throughout this brochure, with the EMA / Ph.Eur. terminology taking precedent, unless specific USP monographs are being referred to.





4. DEVICE SAFETY, QUALITY AND EFFICACY - ISO

Most orally inhaled and nasal drug products (OINDPs) are unique dosage forms in so far as that they comprise two components:

- (a) The drug formulation(s)
- (b) The medical device delivering that formulation to the patient

The responsibility of defining the standards relating to the medical device resides with the **International Standards Organisation (ISO)**.

The relevant standards are “ISO 20072 Aerosol drug delivery device design verification – Requirements and test methods” for Inhalers and “ISO 27427 Anaesthetic and respiratory equipment – Nebulising systems and components” for nebulisers.

5. EXPERT GROUPS

In addition to the above, there are a number of industry and quasi-industry expert groups whose role is to assist the regulatory bodies in establishing best practice in their thinking and guidance.

- **European Pharmaceutical Aerosol Group (EPAG)**

A group of 28 member companies active in the OINDP market within Europe, formed to establish scientifically based best practice, provide consensus comment to industry and government agencies on safety and quality issues and recommend harmonised standards and methodology. Copley is an invited member of the cascade impactor sub-team.



- **International Pharmaceutical Consortium on Regulation and Science (IPAC-RS)**

A group of 21 international companies committed to advancing consensus-based, scientifically driven standards and regulations for OINDPs worldwide. Copley is an associate member.



- **Product Quality Research Institute (PQRI)**

PQRI is a collaborative organisation involving the FDA's CDER, industry and academia. A research organisation, it was formed to provide consensus advice on the scientific information to be submitted in a regulatory filing to CDER and has been involved in a number of OINDP related products.

Current Pharmacopoeial Specifications

As can be seen from the preceding pages, there are many advantages to using inhaled drugs for targeting the lungs or nasal mucosa as a means of providing local or systemic therapy.

These advantages have led to a growing number of new types of device designed to provide the accuracy and sophistication necessary to deliver the drugs concerned.

Other challenges have presented themselves over the last two decades involving drug delivery device changes, not least the ban on ozone depleting chlorofluorocarbons (CFCs) used as propellants in MDIs and the incorporation of dose counters into multi-dose devices.

The regulatory bodies (CFDA, EMA, FDA, MHLW, ICH and others) are constantly evolving their requirements (both in terms of pharmaceutical development and manufacture) to meet the challenges of these new technologies and to ensure their safety, quality and efficacy in the global marketplace.

This effort has been matched by the Pharmacopoeias whose role it is to lay down suitable quality standards and test methods to meet the regulatory requirements and to harmonise their approach to the *in vitro* testing of these devices.

Apart from the mandatory testing for leachables, extractables and microbial contaminants, two of the main factors largely recognised as CQAs in the testing of OINDPs (in both pharmaceutical development and batch release) are:

- **Delivered Dose (Emitted Dose)**

The total amount of drug emitted from the drug device and hence available to the user and

- **Particle Size (Aerodynamic Size Distribution)**

The size of the particles or droplets that make up the emitted aerosol cloud. Particle size determines the percentage of the total emitted dose that actually reaches the lungs or nasal mucosa during inhalation and is thus, therapeutically effective.

These two physical tests form the basis of many of the parameters used by the regulators to characterise inhalation and nasal products.

6A. DELIVERED DOSE

The sampling apparatus used for determining the amount and uniformity of the delivered dose for MDIs was originally designed by Charles Thiel who was then at 3M Laboratories, Minneapolis, USA.

The design has subsequently been amended to replace the original screw fittings with easier-to-use bayonet fittings, whilst maintaining the critical internal dimensions of the original design.

A second and larger sampling apparatus, the sampling apparatus for DPIs, has been introduced for DPIs based on a similar design by Byron and Hindle, Virginia Commonwealth University.

Both types of apparatus appear in the Ph. Eur. under Dosage Forms - Preparations for Inhalation 0671 and in the USP under chapter <601>.

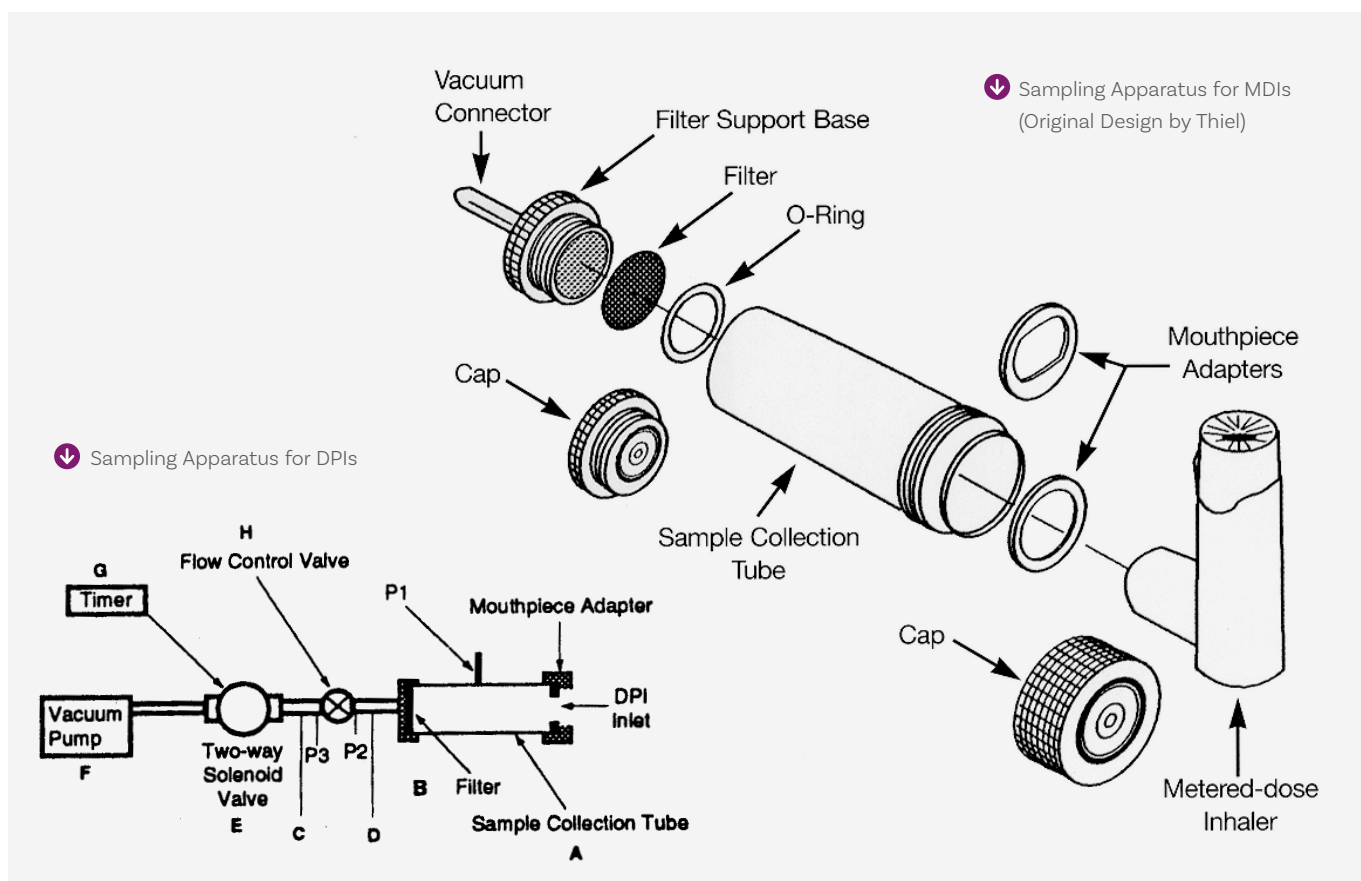

Current Pharmacopoeial Specifications

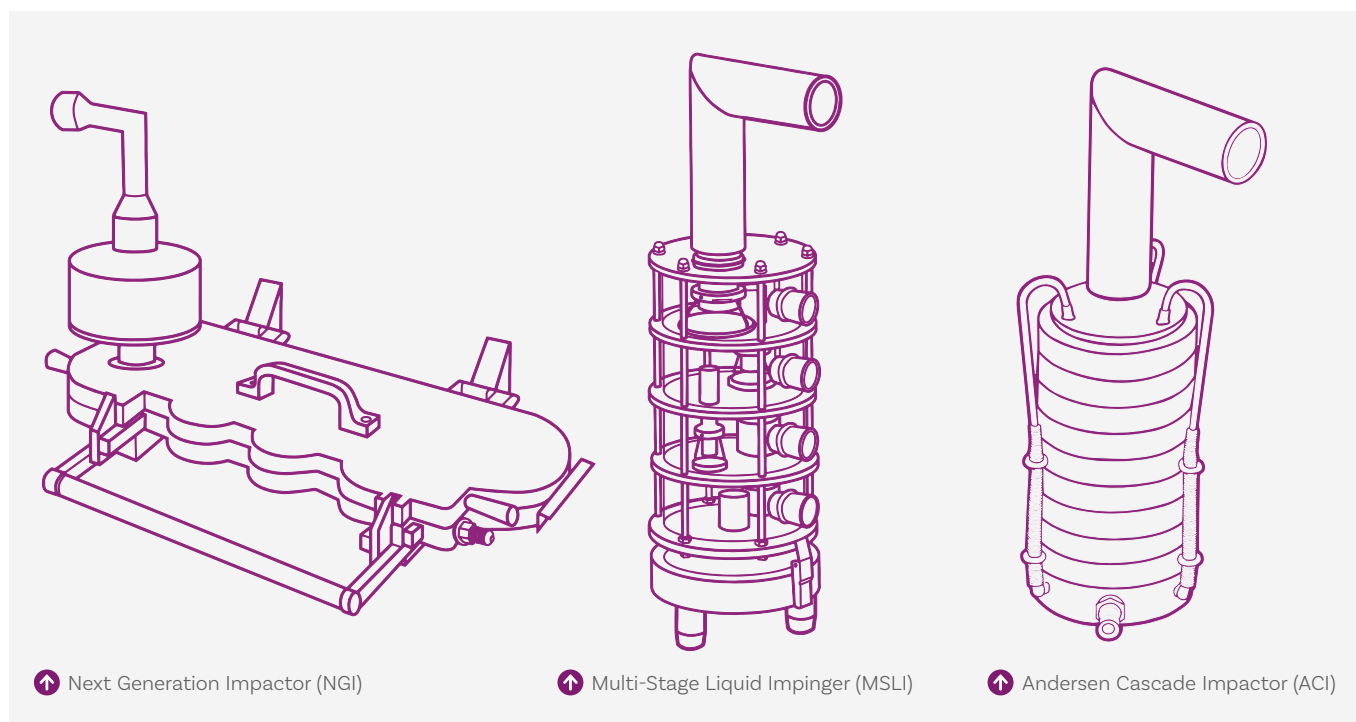

Next Generation Impactor (NGI)

Multi-Stage Liquid Impinger (MSLI)

Andersen Cascade Impactor (ACI)

6B. PARTICLE SIZE (AERODYNAMIC SIZE DISTRIBUTION)

The cascade impactor is the instrument of choice for both regulators and Pharmacopoeias when measuring the aerodynamic particle size distribution of inhaled products.

The aerodynamic particle size distribution of an aerosol cloud defines where the particles in that cloud are likely to deposit following inhalation. It is generally accepted, for example, that to be therapeutically effective the particles should be in the range of 1 to 5 microns in order to deposit in the lungs. The particle mass below 5 microns is normally described as the fine particle mass.

Particles having an aerodynamic size in excess of 5 microns will generally impact in the oropharynx and be swallowed whereas below 1 micron the possibility exists that the particles will remain entrained in the air stream and be exhaled.

The **European Pharmacopoeia (Ph.Eur.) Method Chapter 2.9.18** currently specifies one twin and three multi-stage impactors for the aerodynamic assessment of fine particles in both MDIs and DPIs:

- Ph.Eur. Apparatus A: Twin Impinger (Glass)
- Ph.Eur. Apparatus C: Multi-Stage Liquid Impinger (MSLI)

- Ph.Eur. Apparatus D: Andersen Cascade Impactor (ACI)
- Ph.Eur. Apparatus E: Next Generation Impactor (NGI)

Procedures for Apparatus E - NGI (Chapter 2.9.44) are also specified for nebulisers.

The **United States Pharmacopoeia (USP) Test Chapter <601>** specifies six impactors suitable for aerodynamic size distribution:

- USP Apparatus 1 for MDIs: Andersen Cascade Impactor (ACI)
- USP Apparatus 2 for DPIs: Marple Miller Impactor (MMI)
- USP Apparatus 3 for DPIs: Andersen Cascade Impactor (ACI) + Preseparator
- USP Apparatus 4 for DPIs: Multi-Stage Liquid Impinger (MSLI)
- USP Apparatus 5 for DPIs: Next Generation Impactor (NGI) + Preseparator
- USP Apparatus 6 for MDIs: Next Generation Impactor (NGI)

At the current time, only three impactors appear in both Ph.Eur. and USP:

- Multi-Stage Liquid Impinger (MSLI)
- Andersen Cascade Impactor (ACI)
- Next Generation Impactor (NGI)

Both Pharmacopoeias specify test methods for all three impactors for use with DPIs and for the NGI for nebulisers - see Ph.Eur. Chapter 2.9.44 and USP Chapter <1601>.

In the case of USP however, the use of the MSLI is restricted to DPIs only, which leaves just the ACI and NGI as suitable candidates for testing both DPIs and MDIs, if both Pharmacopoeial standards are to be satisfied.

The **Chinese Pharmacopoeia (ChP) Chapter <0951>** specifies three impactors suitable for APSD studies:

- ChP Apparatus 1: Twin Impinger (Glass)
- ChP Apparatus 2: Andersen Cascade Impactor (ACI)
- ChP Apparatus 3: Next Generation Impactor (NGI)

Delivered Dose Uniformity

Introduction

The safety, quality and efficacy of orally inhaled and nasal drug products (OINDPs) is typically dependent on four critical quality attributes (CQAs):

- The Delivered Dose (the amount of drug that the patient actually receives)
- The Aerodynamic Particle Size Distribution of that dose (or more precisely the fraction of the delivered dose of the appropriate size to reach the target site)
- The presence and possible inhalation of leachables or microbial contaminants
- In some instances, the spray pattern or plume geometry of the device under test

The Delivered Dose is measured by firing the test device into a sampling apparatus containing a filter.

The dose is captured, the active drug is dissolved in solvent and an aliquot is then analysed, normally using High Pressure Liquid Chromatography (HPLC).

During testing, air is drawn through the sampling apparatus to broadly simulate inhalation. The manner in which the air is drawn through the apparatus is dependent on the device under test.

MDIs are relatively insensitive to changes in flow rate because the aerosolisation and dispersion mechanism is dependent on the force generated by the propellant. Therefore, for MDIs, the air flow rate is fixed at an arbitrary rate of 28.3 L/min, equivalent to 1 cubic foot per minute (1 cfm).

For DPIs, the test regime is more complex. The aerosolisation of DPIs depends on the strength and duration of a single inhalation on the part of the user.

When inhaling in this manner, the typical adult produces a pressure drop over the

device of approximately 4 kPa. Depending on the **device flow resistance** this will yield a flow rate, typical of the mean patient inhalation flow rate, that is then used for all the required testing of that device.

Similarly, the duration of the test is set on the basis of the **total air volume** typically inhaled in one adult breath, adjudged to be 4 litres in the case of the Ph.Eur. and 2 litres in the case of the FDA and USP. However this volume is not stated in the case of the ChP.

In the case of nebulisers and MDIs with spacers or VHCs, the user inhales the drug as part of tidal breathing, at rest. In this instance, the breathing cycle *in vitro* is replicated by means of a breathing simulator.



↓ DUSA for MDIs (Aluminium)

Delivered Dose Uniformity (DDU)



The **Delivered Dose** is the mass of the drug that is emitted from the mouthpiece of an inhaler when the device is actuated according to the manufacturer's instructions.

The tests described under **Delivered Dose Uniformity (DDU)** are designed to demonstrate:

1. The consistency of drug emitted from a number of inhalers within a specified batch
2. In the case of multi-dose inhalers, the consistency of drug emitted from various actuations throughout the life of a specified inhaler
3. That the number of deliveries per inhaler is equal to or greater than the labelled amount
4. In the case of DPIs, that the effect of varying flow rates as demonstrated by various patients has been taken into account

The sampling procedure and acceptance criteria for the DDU of orally inhaled products (OIPs) varies according to the Regulatory Authority concerned (see below).

EUROPEAN MEDICINES AGENCY (EMA)

The EMA guidance for OINDPs is contained in the 2006 publication "Guideline on the Pharmaceutical Quality of Inhalation and Nasal Products" and is divided into two sections, one relating to pharmaceutical development and a second relating to product manufacture.

In the case of DDU, it applies to all MDI (pressurised and non-pressurised) and DPI products.

The main study applicable to pharmaceutical development relates to the **DDU through container life**.

A further study is required in the case of DPIs, **DDU over patient flow rate range**. This is because DPIs rely on the patient's inspiration for their therapeutic effectiveness.

As far as manufacture is concerned, tests are required to determine both the **Delivered Dose Uniformity and the Mean Delivered Dose**.

The Mean Delivered Dose is the amount of drug in one actuation and is determined by calculating the mean of the DDU test results. Limits of +/-15% of the label claim apply.

Regarding the method to be employed, the EMA simply states that the DDU test should be conducted according to "an accepted pharmacopoeial method, or a suitably validated alternative".

EUROPEAN PHARMACOPOEIA (PH.EUR.)

The references in the Ph.Eur. to the "Uniformity of delivered dose", the "Number of deliveries per inhaler" and, in the case of DPIs, the "Number of deliveries per inhaler for multidose inhalers" are to found under "Preparations for Inhalation" in the chapter on Dosage Forms (0671).

In the case of DDU, the following sampling procedure applies to MDIs and reservoir DPIs.

Ph.Eur. specifies that a single dose be collected from 10 inhalers, collecting the dose at the beginning (from 3 inhalers), middle (from 4 inhalers) and end (from 3 inhalers) of the number of doses stated in the label.

To comply, 9 out of the 10 results must lie between 75% and 125% of the mean value and all between 65% and 135%. If 2 or 3 values lie outside the 75% - 125% limits then the test must be repeated for 20 more doses whereupon not more than 3 of the 30 values lie outside the 75% - 125% band and no value

lies outside the 65% - 135% band. The mean value must also be between 85% - 115% of the label claim (LC) for delivered dose.

If the inhaler contains more than one active, then a separate test should be carried out for each individual drug. Checks are also required to ensure that the number of deliveries from the device are within the stated label claim.

For pre-metered DPIs, 10 individual doses should be collected and analysed.

FOOD & DRUG ADMINISTRATION (FDA)

The FDA guidelines on MDIs and DPIs are contained in the Draft Guidance, Revision 1, published in 2018. The FDA recommends a new approach of **Parametric Tolerance Interval Testing (PTIT)** for evaluating DDU. Alternatively a traditional counting test may be used.

The **Counting Test** recommends two tiers of testing. In the first tier, for pre-metered DPIs, for each of 10 units not more than one out of 10 values should lie outside 80 - 120% of the **Target Delivered Dose (TDD)**.

For MDIs and device-metered DPIs, for each of 10 units, the initial and last dose are measured. Not more than 2 out of 20 values should lie outside 80 - 120% of the TDD.

For all doses, no single value should be outside 75 - 125% of the TDD.

For pre-metered DPIs, the mean should not be outside 85 - 125% of the TDD. For MDIs and device-metered DPIs, the mean of the values for the initial dose and the mean of the values for the last of the labelled doses should not be outside 85 - 115% of the TDD.

If the 80 - 120% requirements are not met then second tier testing can be performed on an additional 20 units.

In this case not more than 3 out of 30 values should lie outside 80 - 120% of the TDD for pre-metered DPIs, or not more than 6 out of 60 values should lie outside 80 - 120% of the TDD for MDIs and device-metered DPIs. For all doses, no single value should be outside 75 - 125% of the TDD.

For pre-metered DPIs, the mean should not be outside 85 - 115% of the TDD.

For MDIs and device-metered DPIs, the mean of the values for the initial dose and the mean of the value for the last of the labelled doses should not be outside 85 - 115% of the TDD.

UNITED STATES PHARMACOPEIA (USP)

The references in USP 41 to DDU are to be found in chapter <601>.

In the case of multiple dose devices the USP specifies that 2 samples should be taken from 10 separate inhalers, representing a sample at the beginning and end of each unit life, making a total of 20 determinations.

For single dose devices, DDU should be performed on one sample from each of 10 inhalers.

Currently the USP no longer states specific acceptance criteria for orally inhaled products, leaving acceptance criteria to the FDA.

Note: The Chinese Pharmacopoeia Chapter (0111) has similar specifications to those of the European Pharmacopoeia (0671).

Delivered Dose Uniformity - Key Criteria

Organisation	1st Test Tier No. of Inhalers	1st Test Tier Criteria	2nd Test Tier No. of Inhalers	2nd Test Tier Criteria
EMA 2006 Delivery Dose Uniformity DDU through container life	See Ph.Eur. below	See Ph.Eur. below	See Ph.Eur. below	See Ph.Eur. below
Ph.Eur. 9.0 (0671) / Ch.P. 2015 (0111) Uniformity of delivered dose	10 Inhalers / 1 dose (Pre-Metered DPIs) 10 Inhalers / 1 dose (Multidose Devices)	9/10 doses to be 75-125% of Mean Value All doses to be 65-135% of Mean Value Mean to be 85%-115% of LC	20 Inhalers / 1 dose (Pre-Metered DPIs) 20 Inhalers / 1 dose (Multidose Devices)	27/30 doses to be 75-125% of Mean Value All doses to be 65-135% of Mean Value Mean to be 85%-115% of LC
FDA Draft Guidance 2018 (Rev. 1) Delivered Dosage Uniformity (Counting Method)	10 Inhalers / 1 dose (Pre-Metered DPIs) 10 Inhalers / 2 doses (MDIs and Device-Metered DPIs)	9/10 or 18/20 doses to be 80-120% of TDD All doses to be 75-125% of TDD Mean to be 85-115% of TDD	20 Inhalers / 1 dose (Pre-Metered DPIs) 20 Inhalers / 2 doses (MDIs and Device Metered DPIs)	27/30 or 54/60 doses to be 80-120% of TDD All doses to be 75-125% of TDD Mean to be 85-115% of TDD
USP 41 <601> Delivered Dose Uniformity	10 Inhalers / 1 dose (Single Dose Devices) 10 Inhalers / 2 doses (Multiple Dose Devices)	Not applicable	Not applicable	Not applicable

Dosage Unit Sampling Apparatus (DUSA) for MDIs

INTRODUCTION

The Delivered Dose is the **total** amount of drug emitted from the device and hence available to the patient.

Its uniformity is a Critical Quality Attribute (CQA) in determining the safety, quality and efficacy of an orally inhaled and nasal drug product (OINDP).

Based on an original design by Charles Thiel in 3M's laboratories in Minneapolis, USA, the **Dosage Unit Sampling Apparatus (DUSA) for MDIs** has been designed specifically for the

sampling and testing of MDIs and Nasal Aerosols.

It is used to perform those tests specified in the Pharmacopoeias relating to "delivered" or "emitted" dose, namely "Uniformity of Delivered Dose", "Dose Content Uniformity (DCU)" and "DDU or DCU through container life".

Over the years, the design of the sampling apparatus has been refined to improve user-friendliness and productivity whilst maintaining the critical internal dimensions specified by the Pharmacopoeias.

"Quick Release" bayonet caps and adapters, for example requiring a simple quarter-turn, have now replaced the more cumbersome screw thread fittings. The old fixed disc type mouthpiece adapter has been superseded by the interchangeable, and hence more versatile, sheath type mouthpiece adapter (see Page 90).



← DUSA for MDIs with Stand (incl. base plate, boss head and clamp)



↓ Component Parts (and example MDI)

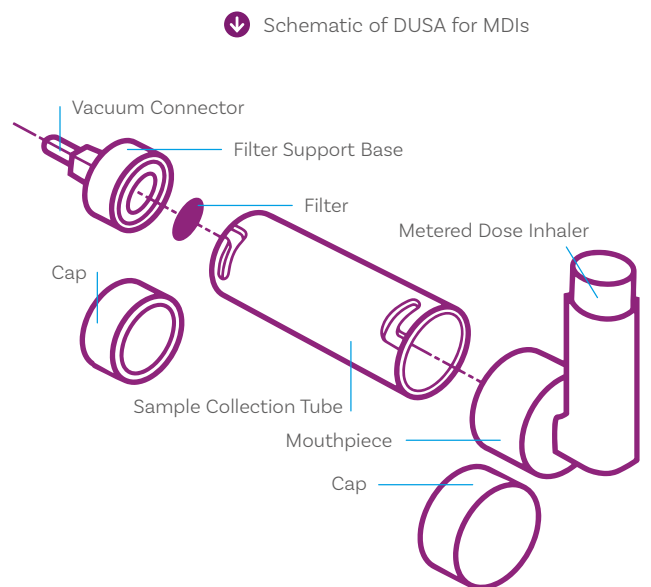

↓ Schematic of DUSA for MDIs

↓ Schematic of DUSA for MDIs with Pump (Ph.Eur.)

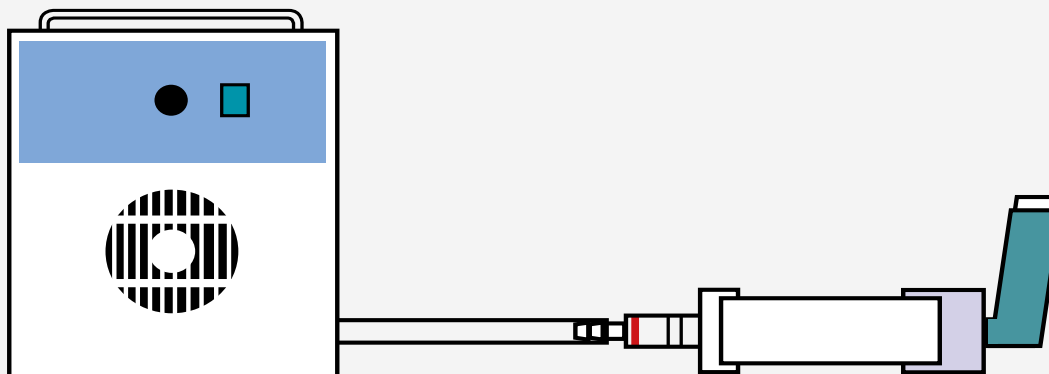

DESCRIPTION

The DUSA for MDIs and Nasal Aerosols consists of one collection tube, two rinsing caps, one filter support cap and one flow meter cap supplied in a handy carrying case.

The standard collection tube itself and rinsing caps are manufactured from an high-quality, inert **polypropylene**, specifically formulated for medical and pharmaceutical applications.

Alternative materials, such as aluminium and 316 stainless steel, are also available, if required. All tubes and caps are **laser numbered** to assist with traceability.

Spare collection tubes and caps are also available as individual parts.

The sample collection tube is fitted with a 25 mm glass fibre filter having a pore size of 1 micron and typical aerosol retention of 99.98% of 0.3 micron particles.

The standard unit comes with high quality silicone rubber seals. Polyethylene (LDPE) seals are available as an option, in the event of drug incompatibility or extractables being an issue with silicone rubber.

A stand comprising base plate, boss head and clamp for supporting the DUSA during use is available as an option.

The combination of the clamp to secure the filter support cap and the boss head to alter its angle allows collection tubes to be quickly connected to the vacuum system prior to

testing and removed once the test is complete.

A further base plate option includes mounting fixtures for the Waste Shot Collector (see Page 31) and switching valve.

Using a Waste Shot Collector, a switching valve mounted on the base plate used to support the DUSA, in conjunction with a single complete DUSA, 9 spare collection tubes, 18 spare rinsing caps and 11 mouthpiece adapters (10 for the DUSA collection tubes and one for the Waste Shot Collector) can provide substantial gains in terms of throughput.

↓ Schematic of DUSA for MDIs with Pump and BAC 2100 to restrict the volume of air sampled to no more than 2 litres (USP)

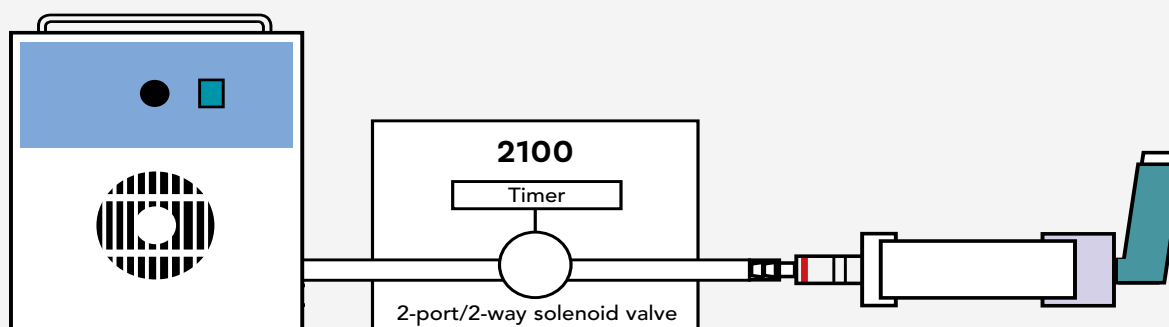

Dosage Unit Sampling Apparatus (DUSA) for MDIs

↓ System for Testing the Dose Uniformity of MDIs (incl. Waste Shot Collector and Switching Valve)



PROCEDURE (PH.EUR.)

The minimum set-up for delivered dose testing as specified by Ph.Eur. comprises a sample collection tube, fitted at one end with a suitable mouthpiece adapter to accept the inhaler under test and connected at the other end to a vacuum pump capable of continuously drawing 28.3 L/min through the assembled system (including the filter and inhaler).

A flow meter (see pages 88 - 89) should be used to adjust the flow at the inlet to the correct rate prior to testing, using the flow meter cap.

Once the device has been shaken, primed and actuated and the test is complete, the collection tube together with the filter is removed. Solvent is then added and the tube capped and agitated to assist in drug dissolution prior to recovery and analysis.

PROCEDURE (USP)

In addition to the specifications laid down in Ph.Eur., the FDA recommends, and USP specifies, that the volume of air sampled should not exceed 2 litres, this being the volume of air adjudged to be typical of the average patient.

This additional criterion can be met by positioning an electrically operated, timer controlled, two-way solenoid valve, such as that incorporated in the **Breath Actuation Controller Model BAC 2100** (see Page 86), in the line between the collection tube and the vacuum pump to control the air flow supply to the inhaler.

The BAC 2100 provides near instantaneous starting and stopping of the air flow during testing and has both delay and inhaled time functions. This allows the time that the test flow is applied to the inhaler to be adjusted

to a specific volume, for example, the 2 litres required by USP.

Operation can be triggered via the instrument front panel, foot switch, MDI Actuation Sensor or RS232 interface.

The BAC 2100 can also be used for the testing of Breath-Actuated (or Breath Operated) MDIs.

In this case, the BAC 2100 is used to initiate the flow and hence trigger the breath actuated inhaler simultaneously.

A DUSA Shaker for holding up to 21 DUSA for MDI collection tubes is available to assist in the process of drug dissolution and drug recovery (see Page 114).



↑ DUSA for MDIs with Breath Actuation Controller Model BAC 2100 and Pump testing a Breath Actuated MDI

← Stand for 10 MDI Collection Tubes



BRITISH PHARMACOPOEIA

It is important to note that, in addition to the Ph. Eur. specified DUSA, the **British Pharmacopoeia** has its own unique apparatus for determining the “Content of Active Ingredient delivered by actuation of the valve”, likely retained for historical reasons.

This comprises a stainless steel base plate having three legs and a central hole to accept the actuator stem in a small vessel (to which solvent is added) suitable for shaking.

ANCILLARIES

The following ancillaries are required to complete a fully operating test system for the delivered dose testing of MDIs:

- Mouthpiece Adapter (see Page 90)
- Vacuum Pump (see Page 91)
- Breath Actuation Controller (see Page 86)
- Flow Meter (see Page 88)
- Waste Shot Collector (see Page 31)
- Option: DUSA Shaker (see Page 114)



↑ DUSA Shaker for MDIs

Cat. No. Description

- | | |
|-------|---|
| 8201 | Dosage Unit Sampling Apparatus for MDIs (Silicone Rubber Seals) |
| 8201A | Dosage Unit Sampling Apparatus for MDIs (LDPE Seals) |

Accessories

- | | |
|------|---|
| 8111 | Stand (incl. Base Plate, Boss Head and Clamp) |
| 8211 | Stand for 10 Collection Tubes |

Spare Parts

- | | |
|-------|---------------------------------------|
| 8202 | Set of 3 Silicone Rubber Seals |
| 8202A | Set of 3 LDPE Seals |
| 8203 | Collection Tube |
| 8204 | Filter Support Cap |
| 8205 | Rinsing Cap (Silicone Rubber Seal) |
| 8205A | Rinsing Cap (LDPE Seal) |
| 8206 | Flow Meter Cap (Silicone Rubber Seal) |
| 8206A | Flow Meter Cap (LDPE Seal) |
| 8207 | Stainless Steel Filter Support Disc |
| 8210 | Pack of 500 Glass Fibre Filters |

Note: Aluminium or 316 Stainless Steel DUSAs are available, if required

- | | |
|------|--|
| 8212 | BP Content Uniformity Apparatus for MDIs |
|------|--|



↑ BP Content Uniformity Apparatus for MDIs

Dosage Unit Sampling Apparatus (DUSA) for DPIs

System for testing the Dose Uniformity of DPIs (inc. Waste Shot Collector and Switching Valve.)



INTRODUCTION

A second and larger version of the Dosage Unit Sampling Apparatus (DUSA) for MDIs, capable of sampling at a variety of flow rates up to 100 L/min, is available for use with Dry Powder Inhalers (DPIs) and Nasal Powders.

The DUSA for DPIs is used to perform those tests specified by the Pharmacopoeias that relate to “delivered” or “emitted” dose, namely “Uniformity of Delivered Dose”, “Dose Content Uniformity” and “DDU or DCU through container life”. It can also be used to **characterise the flow resistance** of any DPI.

As with the system suggested for testing MDIs according to USP <601>, an electrically

operated, timer controlled, two-way solenoid valve is positioned in the line between the collection tube and the vacuum pump to control the air flow supply to the inhaler.

In the case of DPIs this is mandatory because, unlike MDIs, the majority of these devices are passive breath-actuated devices which rely on the patient’s inspiration rather than a propellant for dose emission.

The testing of DPIs is further complicated by the fact that different inhalers provide varying degrees of resistance to flow, i.e. some require more effort to inhale through than others.

Instruments such as the **Critical Flow Controller Model TPK 2100** (see Page 84) interposed between DUSA and vacuum pump simplify set-up in accordance with these pharmacopoeial recommendations, measuring and recording all the parameters required for testing and controlling flow conditions and ensuring critical (sonic) flow conditions during testing.

They also allow the time that the test flow is applied to the inhaler to be adjusted to a specific volume, for example 2 or 4 litres, to represent the inhalation volume of a typical patient.

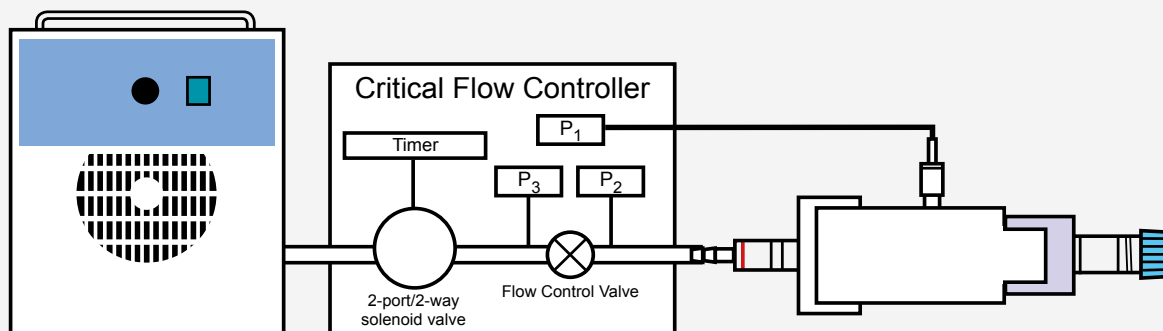

Schematic of Sampling Apparatus for DPIs with Pump and Critical Flow Controller

Dosage Unit Sampling Apparatus (DUSA) for DPIs

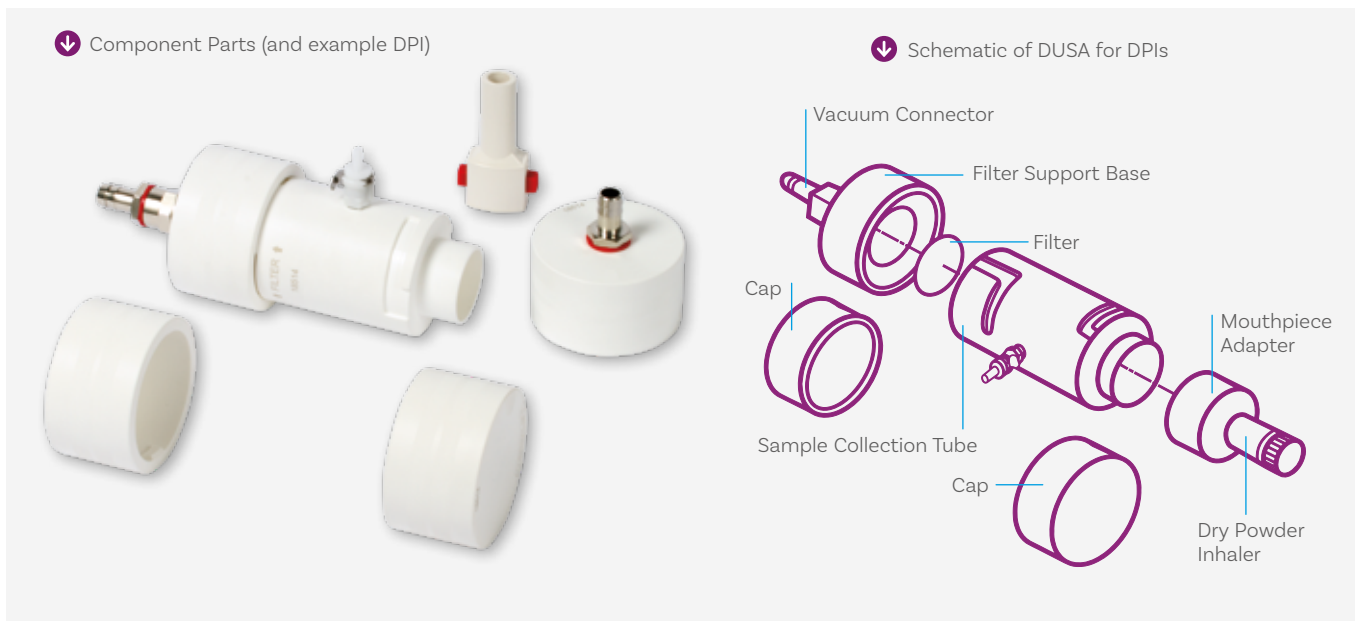

DESCRIPTION

The Dose Unit Sampling Apparatus (DUSA) for DPIs utilises the same materials of construction as the unit for MDIs. Alternative materials, such as aluminium and 316 stainless steel, are also available, if required.

The apparatus comprises one collection tube, two rinsing caps, one filter support cap and one flow meter cap, and comes complete in a handy carrying case.

In this case, the sample collection tube is fitted with a 47 mm glass fibre filter enabling

dosage collection at the higher flow rates - up to 100 L/min - when necessary.

The collection tube also differs from that employed for MDIs in having a pressure tap (P1) in its wall that is used in conjunction with a critical flow controller to measure the pressure drop across the device.

Spare collection tubes without a pressure tap (P1) are also available for subsequent dose collections, once the test flow rate has been determined and the first dose collected.

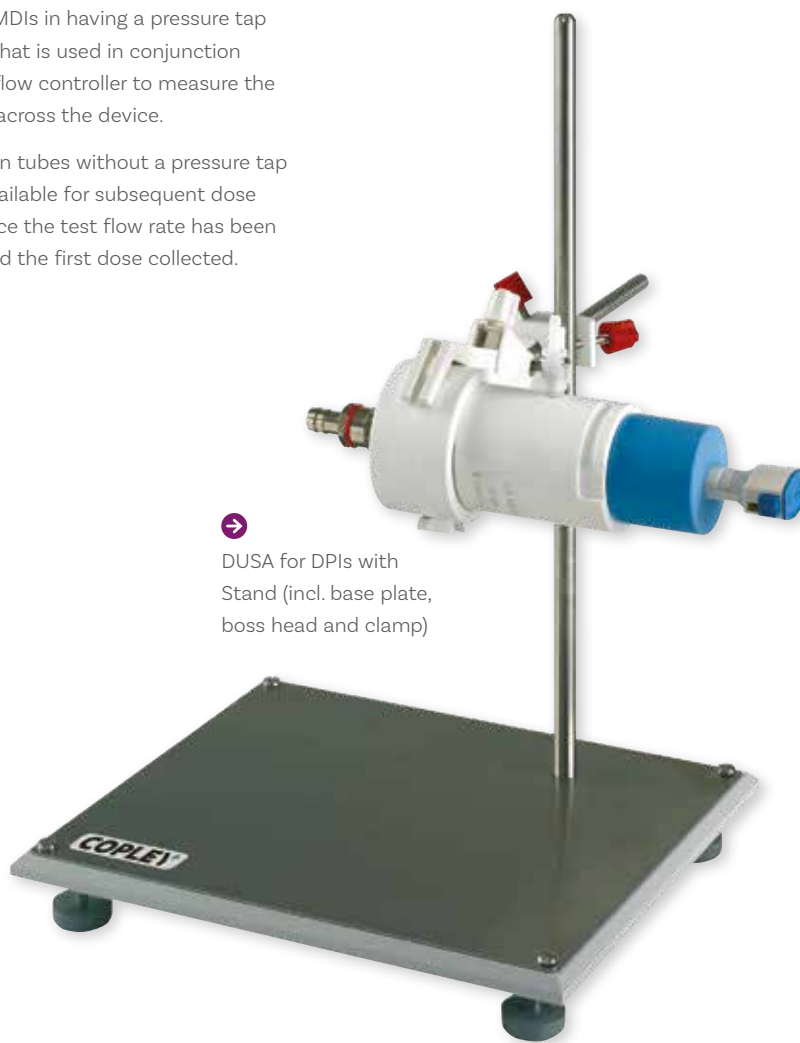

Dosage Unit Sampling Apparatus (DUSA) for DPIs



PROCEDURE

The minimum start-up requirement for DPI delivered dose testing is the same as that for MDI testing described in the preceding section, namely DUSA, mouthpiece adapter, pump and flow meter, plus the addition of a critical flow controller (e.g. TPK 2100) to measure the pressure drop across the device and control the flow conditions during testing accordingly.

Proceed as follows:

1. Assemble the system as per the schematic of the DUSA for DPIs
2. Connect the inhaler to the collection tube using a suitable mouthpiece adapter
3. Connect the tube marked P1 on the critical flow controller to the pressure tap on the collection tube
4. Switch on the pump, open the 2-way solenoid valve and adjust the flow control valve until the differential pressure on the display reads 4 kPa
5. Check that critical (sonic) flow is being achieved through the flow control valve by checking the P2 and P3 values on the display
6. Replace the inhaler with a flow meter and measure the flow rate, Q. Then, using the pre-determined flow rate, Q, and the critical flow controller timer controls, adjust the test flow duration to give an inspiration volume of 4 (or 2) L

7. Replace the inhaler and discharge the dose into the collection tube by activating the timer on the critical flow controller controlling the solenoid valve. Repeat as necessary to achieve the desired number of doses
8. Add solvent to the collection tube, apply rinsing caps and then shake the tube vigorously before assaying the contents

Note: The TPK 2100 automates much of this process (see page 84).

ANCILLARIES

The following ancillaries are required to complete a fully operating test system for the delivered dose testing of DPIs:

- Mouthpiece Adapter (see Page 90)
- Vacuum Pump (see Page 91)
- Critical Flow Controller (see Page 80)
- Flow Meter (see Page 88)
- Waste Shot Collector (see Page 31)
- Option: DUSA Shaker (see Page 114)

Cat. No. Description

- | | |
|-------|---|
| 8601 | Dosage Unit Sampling Apparatus for DPIs (Silicone Rubber Seals) |
| 8601A | Dosage Unit Sampling Apparatus for DPIs (LDPE Seals) |

Accessories

- | | |
|------|---|
| 8111 | Stand (incl. Base Plate, Boss Head and Clamp) |
| 8604 | Stand for 10 Collection Tubes |

Spare Parts

- | | |
|-------|---------------------------------------|
| 8602 | Set of 3 Silicone Rubber Seals |
| 8602A | Set of 3 LDPE Seals |
| 8603 | Pack of 100 Glass Fibre Filters |
| 8606 | Filter Support Cap |
| 8607 | Rinsing Cap (Silicone Rubber Seal) |
| 8607A | Rinsing Cap (LDPE Seal) |
| 8608 | Collection Tube with P1 Port |
| 8608A | Collection Tube without P1 Port |
| 8609 | Flow Meter Cap (Silicone Rubber Seal) |
| 8609A | Flow Meter Cap (LDPE Seal) |
| 8610 | Stainless Steel Filter Support Disc |

Note: Aluminium or 316 Stainless Steel DUSAs are available, if required

Waste Shot Collector Model WSC2 for MDIs and DPIs

↓ Waste Shot Collector Model WSC2



↓ Waste Shot Collector Model WSC2 mounted on Stand with Switching Valve



↓ Waste Shot Collector Model WSC2 showing Disposable Cartridge



INTRODUCTION

Both Ph.Eur. and USP state that DDU tests should be carried out on all OIPs and that in the case of **multiple-dose devices*** tests should be carried out throughout the life of the inhaler i.e. **Dose Uniformity over the Entire Contents**.

In the case of Ph.Eur., this involves the collection of 10 doses, throughout the life of each individual inhaler: three doses at the beginning, four in the middle and three at the end.

In the case of an inhaler with 100 labelled doses, for example, then tests would be carried out on dose numbers 2, 3 and 4 (at the beginning of the test), numbers 49, 50, 51 and 52 (in the middle) and numbers 98, 99 and 100 (at the end).

For an inhaler having a label claim of 200 doses, this could mean firing each unit 200 times with no less than 190 shots being fired to waste for each individual container.

Firing to waste requires an evacuation system, which captures the aerosol emitted from repeated actuations of the inhaler, trapping large quantities of the drug for safe disposal.

* In the case of Ph. Eur., for DPIs this only applies to reservoir type devices.

DESCRIPTION

The **Waste Shot Collector WSC2** is a compact vacuum filtration system suitable for use in both MDI and DPI applications.

It can be used in either stand alone mode or integrated into the base plate for the DUSA, via a switching valve, whereby the vacuum pump used on the DUSA powers both sampling and waste collection units.

Using a waste shot collector and a suitable switching valve mounted on the base plate that serves as the stand for the DUSA, in conjunction with two mouthpiece adapters (one for the DUSA and one for the WSC2) and a number (say, 10) of spare collection tubes, can provide substantial gains in terms of throughput.

The external dimensions of the inlet of the WSC2 are identical to those of the DUSA.

This means that the same mouthpiece adapter (and therefore inhaler) can be used with both pieces of equipment.

This approach also ensures that the two pieces of equipment are immediately switchable within the system and that consequently all shots are collected or discharged to waste under identical conditions.

PROCEDURE

The user simply places the inhaler in the mouthpiece of the waste shot collector and fires a shot in the normal manner. A separate tally counter to record the number of shots fired is available.

The waste dose is captured in a disposable cartridge which serves to collect the waste shots and trap the contents in an integral HEPA filter, retaining 99.97% of particles over 0.3 microns.

The waste shot collector measures 150 x 150 x 140 mm (L x W x H).

Cat. No. Description

5000	Stand with Switching Valve
5001	Waste Shot Collector WSC2 (including 1 Cartridge)
5002	Spare Filter Cartridge for Waste Shot Collector
8060	Flow Meter to Induction Port/WSC2 Adapter
5007	Waste Shot Tally Counter

Delivered Dose Sampling Apparatus for Nebulisers with a Mouthpiece

↓ Angle Adapter for Breathing Simulator Model BRS 1100

↓ Filter Holder and Adapter for Breathing Simulator Model BRS 1100



INTRODUCTION

Nebulisers convert liquids into a cloud of droplets suitable for respiration. In the past, nebulisers have been designed to be used with a variety of drugs; the choice of nebuliser and/or drug being dependent on the prescribing clinician. For this reason, the nebuliser and drug were normally marketed and sold as two distinct products.

This is in direct contrast with inhalers which normally deliver a pre-metered dose of medication and which have always been marketed as integrated (or combination) products.

These differences are important since, hitherto, the regulatory bodies have classified nebulisers as medical equipment rather than pharmaceuticals,

for testing purposes, and historically there have been no specific guidelines on characterising the drug preparation itself.

In 2006, the European Medicines Agency (EMA) issued a new “Guideline on the Pharmaceutical Quality of Inhalation and Nasal Products” in which they included regulatory guidance on the drug aspects of nebulisers.

This was on the grounds that the safety and efficacy of nebulisers is dependent on the nebuliser/drug combination and not just on the nebuliser alone.

As a result of the EMA initiative and recognising the lack of suitable test methods for nebulisers, the Pharmacopoeias have now introduced a chapter on “**Preparations for Nebulisation: Characterisation**” (Ph.Eur. 2.9.44 and USP Chapter <1601>).

It is these proposals that form the basis for the tests specified in Annex C of **ISO 27427:2013** requirements for the “safety, performance and testing for general purpose nebulising systems intended for continuous or breath-actuated delivery of liquids in an aerosol form, to humans through the respiratory system” and the tests and equipment outlined below.

DELIVERED DOSE IN NEBULISERS (Mouthpiece-based products)

The effectiveness of any nebuliser is dependent on:

- The total active drug delivered to the user
- The rate at which that active is delivered and
- The aerodynamic size of the particles droplets generated

The breathing pattern employed in the testing of nebulisers is particularly important since *in vivo* this determines the amount of active available to the user.

For this reason, the two tests specified in the Pharmacopoeias to characterise delivered dose, **Active Substance Delivery Rate** and **Total Active Substance Delivered**, are based on standardised tidal flow conditions generated by a breathing simulator, as opposed to the fixed flow rates used for MDIs and DPIs.

A range of breathing patterns are used to reflect the patient population for the products to be tested. This typically covers both adult and paediatric use (see Table on Page 34).



↑ Delivered Dose Sampling Apparatus for Nebulisers with Breathing Simulator Model BRS 1100

Delivered Dose Sampling Apparatus for Nebulisers with a Mouthpiece

DESCRIPTION

The **Sampling Apparatus for Nebulisers (Mouthpiece-based products)** consists of a breathing simulator to generate the specified breathing profile, a filter holder containing the filter to capture the active drug and a suitable mouthpiece adapter to connect the filter holder to the nebuliser under test.

An angle adapter can be provided as an optional extra where required to adjust the angle of the nebuliser mouthpiece to that representative of actual operating conditions.

Copley supply a range of breathing simulators specifically designed to meet the requirements of the tests concerned (see Pages 75-79).

PROCEDURE

Use a suitable breathing simulator to generate the breathing pattern required in conjunction with the **Filter Holder and Adapter, Angle Adapter** and a suitable **Mouthpiece Adapter** to perform these two tests.

Proceed as follows:

1. Assemble the system as per the schematic
2. Connect the nebuliser to the system using a suitable mouthpiece adapter
3. Use the Angle Adapter to ensure that the nebuliser is positioned in the same orientation as intended for use and that the environmental conditions are as stated
4. Set the breathing simulator to generate the specified breathing pattern
5. Start both nebuliser and simulator and run for 60 seconds (or for such time that sufficient active is collected on the filter for analysis)
6. Pause both units and remove the filter from the holder
7. Place a fresh filter in the holder and continue the test until nebulisation ceases, i.e. the reservoir is empty
8. Using a suitable method, determine the amount of active on each filter



↑ Delivered Dose Sampling Apparatus for Nebulisers with Breathing Simulator Model BRS 2100

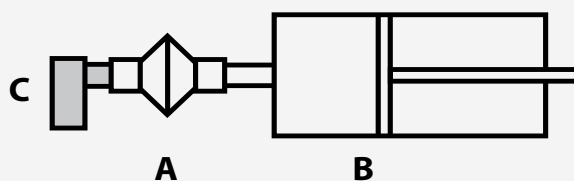

A. inhalation filter and filter holder B. breathing simulator C. nebulizer

Determine the **active substance delivery rate** by dividing the mass of active collected on the first filter by the time taken to collect it.

Determine the **total active substance delivered** by summing the mass collected on both filters.

ANCILLARIES

The following ancillaries are required to complete a fully operating test system for the delivered dose testing of nebulisers with a mouthpiece:

- Mouthpiece Adapter (see Page 90)
- Breathing Simulator (see Page 75)

Cat. No. Description

Mouthpiece-based products

9102	Filter Holder and Adapter for Breath Simulator BRS 1100
9102A	Filter Holder and Adapter for Breath Simulator BRS 2100/3100
9103	Pack of 100 Filters for Filter Holder
9104	Angle Adapter for Breathing Simulator BRS 1100

Delivered Dose Sampling Apparatus For Nebulisers With a Facemask

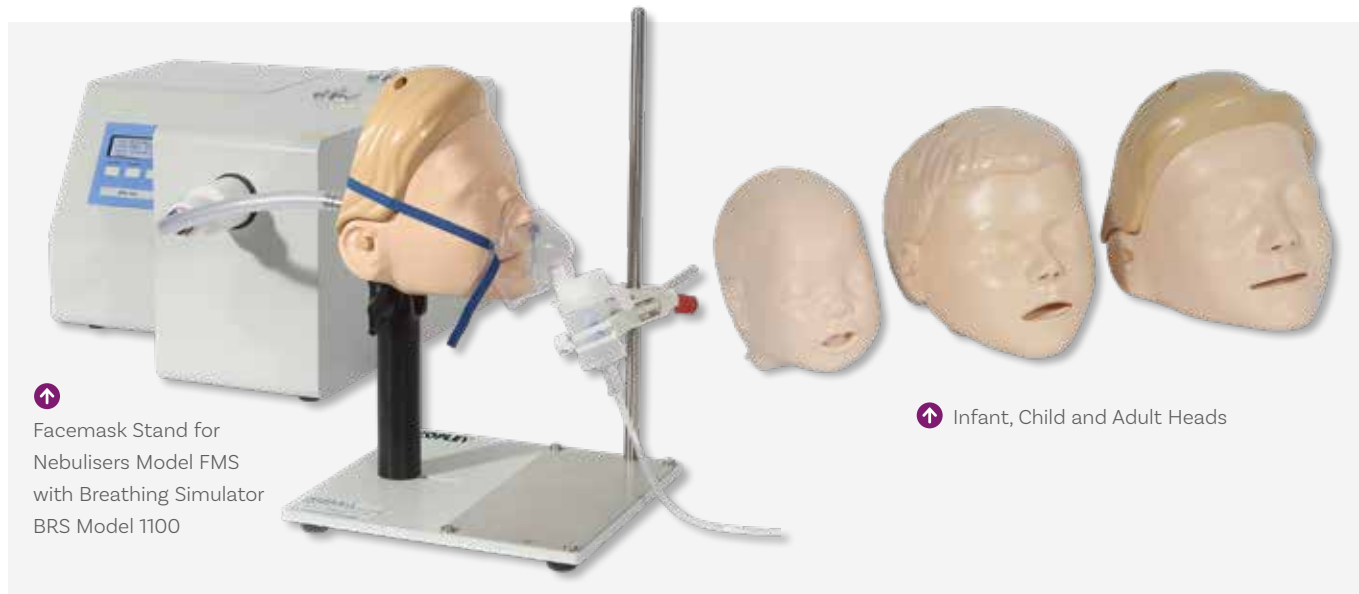

↑
Facemask Stand for Nebulisers Model FMS with Breathing Simulator BRS Model 1100

↑ Infant, Child and Adult Heads

DELIVERED DOSE IN NEBULISERS (Facemask-based products)

One of the main purposes of the tests described in USP Chapter <1601> and Ph. Eur. Chapter 2.9.44 is to assess the rate of delivery to the patient and the total drug substance delivered to the patient under standardised conditions of volumetric flow rate (see preceding pages).

However, neither chapter makes reference to the fact that many nebulisers are used with facemasks instead of mouthpieces to administer the inhaled aerosol. This practice is commonplace in the case of infants and small children and in situations where the user lacks the capability of using a mouthpiece.

This omission is somewhat surprising given that one of the main factors influencing

the amount of inhaled drug available to the patient is the interface between the facemask and the patient.

A properly sized mask, firmly placed against the face, for example, will provide the user with far more drug than a poorly fitting equivalent where much of the drug is lost to the environment through leakage.

DESCRIPTION

Whilst not, as yet, incorporated into the respective Pharmacopoeias, the **Facemask Stand for Nebulisers Model FMS** provides the user with a standardised test method to quantify the effect of using a facemask.

A critical component of the test apparatus is the face model employed. Firstly, it is important that this is appropriate to the age group for which the nebuliser is intended, e.g. infant, child or adult.

The face model should also be such as to:

1. Replicate as closely as possible “real life” conditions in terms of dead space
2. Simulate *in vivo* conditions in having physiologically accurate soft facial tissue
3. Provide a means of mounting the nebuliser such that the facemask is in correct alignment with the face model

The system from Copley seeks to address all of these points, whilst also giving sufficient flexibility to allow users to utilise their own validated face models, if desired.

The FMS comprises two key elements:

1. The **Device Securing Fixture**
This secures the nebuliser and its associated facemask into position prior to testing

Representative Tidal Breathing Patterns for Nebuliser Tests

Parameter	Adult	Neonatal	Infant	Child
Tidal Volume	500 mL	25 mL	50 mL	155 mL
Frequency	15 cycles/min	40 cycles/min	30 cycles/min	25 cycles/min
Waveform	sinusoidal	sinusoidal	sinusoidal	sinusoidal
I/E Ratio	1:1	1:3	1:3	1:2

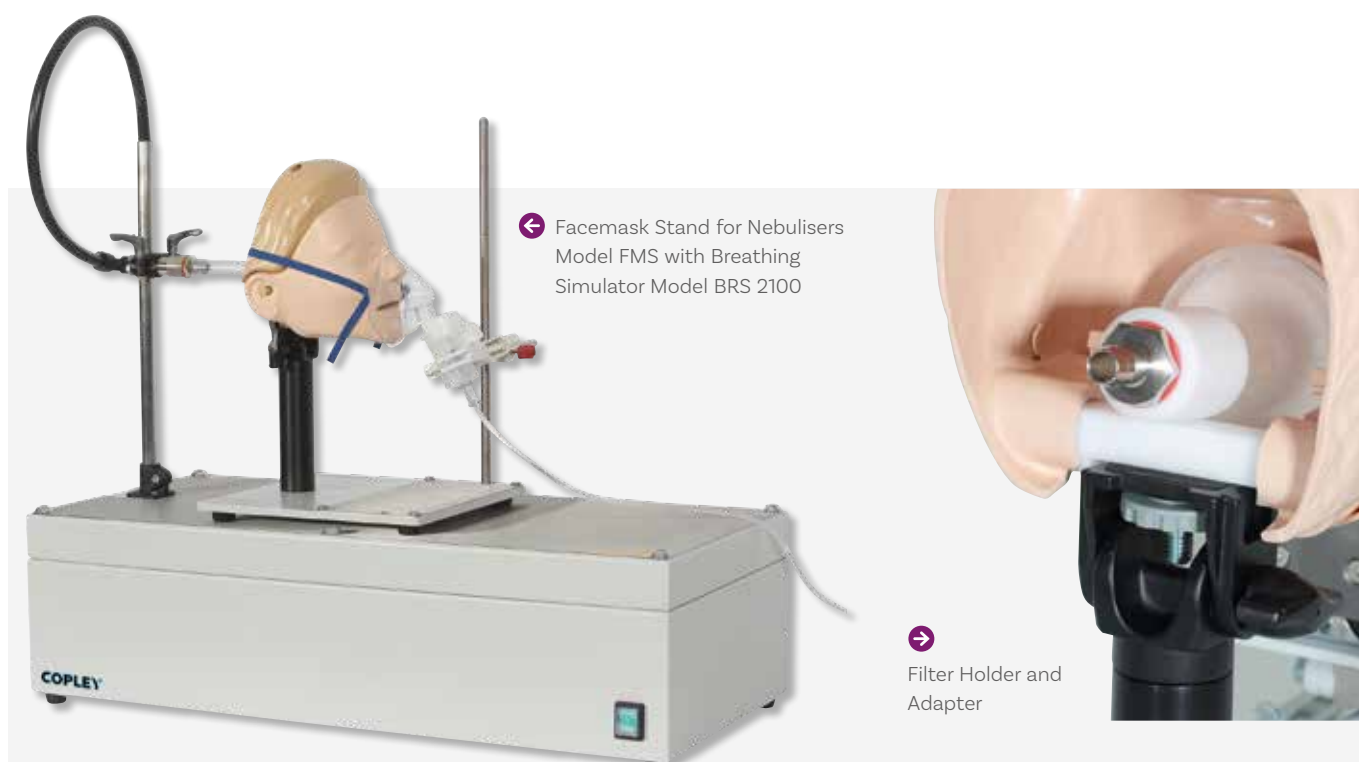

← Facemask Stand for Nebulisers Model FMS with Breathing Simulator Model BRS 2100

→ Filter Holder and Adapter

2. The Face Model Support

This accepts three different models: infant, child and adult. All models are fitted with replaceable face skins which provide flexibility and elasticity associated with “real life” tissue

The support is adjustable in two axes (a) horizontal to accommodate the various face models and (b) to adjust the angle of the face tilt.

PROCEDURE

(Facemask-based products)

Use a suitable breathing simulator to generate the breathing pattern required in conjunction with the FMS to perform the two tests.

Proceed as follows:

1. Assemble the system as instructed
2. Set the breathing simulator to generate the specified breathing pattern
3. Start both nebuliser and simulator and run for 60 seconds (or for such time that sufficient active is collected on the filter for analysis)
4. Pause both units and remove the filter from the holder
5. Place a fresh filter in the holder and continue the test until nebulisation ceases, i.e. the reservoir is empty
6. Using a suitable method, determine the amount of active drug on each filter

Determine the **active substance delivery rate** by dividing the mass of active collected on the first filter by the time taken to collect it.

Determine the **total active substance delivered** by summing the mass collected on both filters.

ANCILLARIES

The following ancillaries are required to complete a fully operating test system for the delivered dose testing of nebulisers with a facemask:

- Breathing Simulator (See Page 75)

Cat. No. Description

Facemask-based products

9156	Facemask Stand for Nebulisers Model FMS
9142	FMA/FMS Filter Holder and Adapter for BRS 1100
9143	FMA/FMS Filter Holder and Adapter for BRS 2100/3100
9103	Pack of 100 Filters for Filter Holder
9144	Adult Head and Adapter for FMA/FMS
9145	Child Head and Adapter for FMA/FMS
9146	Infant Head and Adapter for FMA/FMS
9149	Replacement Face Skins for Adult Head (Pack of 6)
9150	Replacement Face Skins for Child Head (Pack of 6)
9151	Replacement Face Skins for Infant Head (Pack of 6)

Delivered Dose Sampling Apparatus for Spacers and VHCs with a Mouthpiece

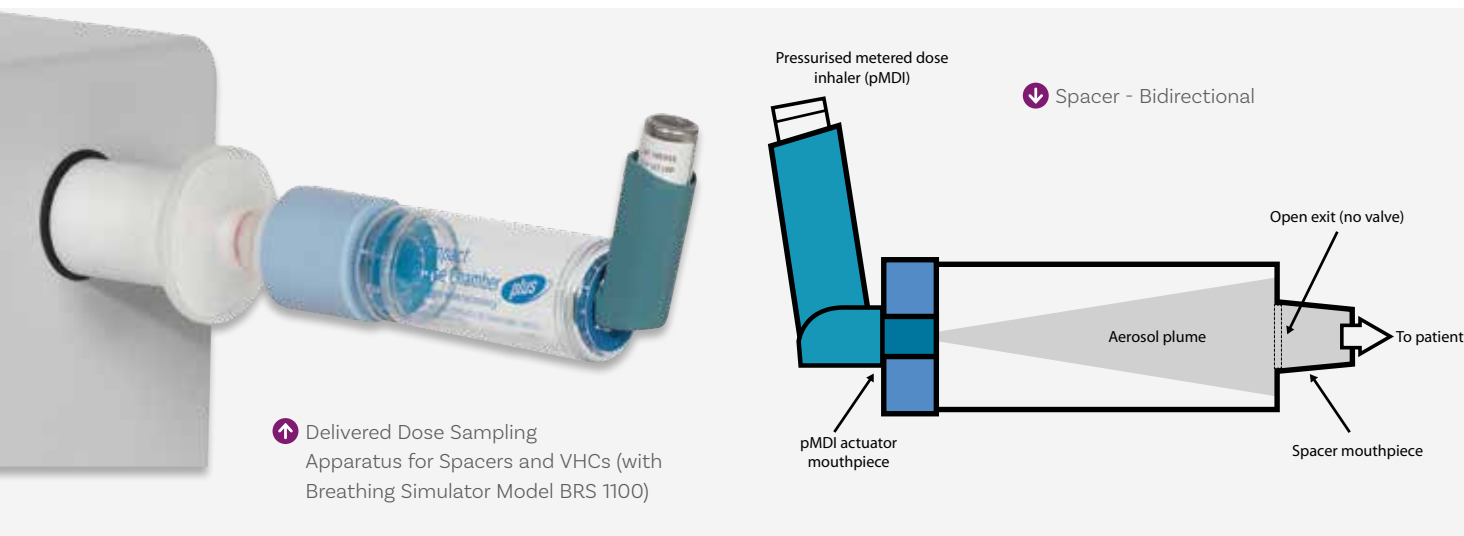

INTRODUCTION

Pressurised Metered Dose Inhalers (pMDIs) or Metered Dose Inhalers (MDIs) are an inexpensive and convenient means of treating asthma and other pulmonary diseases.

However, patient coordination of actuation with inhalation can be a problem when using MDIs particularly in the young, old or chronically ill.

Add-on devices such as **Spacers, Valved Holding Chambers and Reverse Firing VHCs**, which reduce or eliminate the need for coordination between actuation and inhalation, and also the cold Freon® effect (see Page 111), are widely used in conjunction with MDIs to overcome this problem.

A **Spacer** is an open tube placed between the inhaler and the mouthpiece, or in some instances facemask of the patient. In practical terms, they extend the distance between the inhaler and patient and thus provide additional volume for the aerosol plume to develop.

A **Valved Holding Chamber (VHC)** is similar but normally incorporates a one way valve close to the mouthpiece or facemask. This opens to release the aerosol cloud once the patient starts to inhale but prevents emptying of the holding chamber during

exhalation as can happen with a simple spacer device.

Reverse Firing Spacers and VHCs are designed with an integral actuator to accept an inhaler canister directly. The MDI is actuated into a chamber in a direction pointing away from the patient and then the patient inhales slowly from the chamber.

All “Add-on” devices result in the patient inhaling the drug from a reservoir of aerosolised particles, not dissimilar to a nebuliser, rather than directly from the MDI.

IN VITRO ASSESSMENT

When a patient uses an MDI without an add-on device, the emitted dose and hence the drug particles contained within it are inhaled almost instantaneously as the formulation is aerosolised.

In contrast, when an add-on device is used, the patient inhales drug from a reservoir of aerosolised particles.

The additional dead volume provided by the reservoir not only provides a reservoir for aerosol expansion, but also an opportunity for particle impaction, settling and/or electrostatic deposition within the chamber itself, all of which can change the emitted dose ahead of inhalation.

As the use of add-on devices has become more widespread, the regulatory authorities responsible for the safety and efficacy of OIPs have become increasingly aware of the need to test with add-on devices as distinct from MDIs used on their own.

As a result, the USP has released a new chapter for testing **Spacers and Valved Holding Chambers used with Inhalation Aerosols <1602>**.

The tests set out in the new chapter are based on experience in Canada gained over a ten year period culminating in the release of a new standard “Spacers and Holding Chambers for use with Metered-Dose Inhalers” by the Canadian Standard Association in 2011.

The new methods reflect that, as with a nebuliser, the amount of drug received by the patient using an add-on device with an MDI will be directly influenced by the inhalation profile of the user concerned.

For that reason, the tests in the new chapter call for the application of specific breathing profiles to reflect the physiology of the intended user (see Page 37).

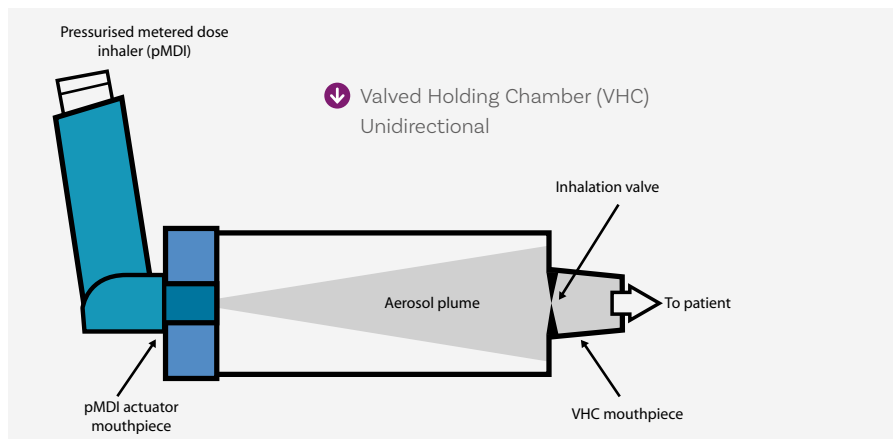

MASS OF DRUG DELIVERED (Without Facemask)

In **Section 4** of chapter <1602>, two series of tests are described to determine the “**Total mass of drug delivered from a spacer/VHC while simulating patient tidal breathing**”.

Section 4.1 describes the procedure to be employed on standard **mouthpiece-based** products, that is to say, those **without a facemask**.

Section 4.2 is reserved for spacers / VHCs supplied **with a facemask** (see Pages 38-39).

Like the DDU test for MDIs, the total active is collected on a filter mounted in this case as close as practically possible to the mouthpiece/mouth spacer/VHC concerned in order to minimise dead volume.

In this instance however, the constant 28.3 L/min air flow rate applied during the testing of MDIs is replaced by a specific patient relevant breath profile more representative of the conditions applicable to add-on devices *in vivo*.

In the case of VHCs, tests are also carried out to compare the dose received when use is coordinated or uncoordinated with device actuation.

Performance is optimal and directly comparable with a normal MDI if the patient inhales from the spacer/VHC as the device is actuated. This near perfect patient-inhaler technique is called “**coordinated use**”.

In contrast, the worst case scenario is if actuation coincides with exhalation i.e., “**uncoordinated use**”.

The **standard sampling apparatus for mouthpiece-based products** consists of a breathing simulator to generate the specified breath profile, a filter holder containing the filter to capture the active drug and a suitable mouthpiece adapter to connect the filter holder to the mouthpiece of the spacer / VHC concerned.

Copley supplies a range of breath simulators specifically designed to meet the requirements of the test concerned (see Page 75).

PROCEDURE

(Without Facemask)

Use a suitable breathing simulator to generate the breathing pattern required in conjunction with the filter holder and a suitable mouthpiece adapter to perform these two tests.

Proceed as follows:

1. Assemble the system as per the manufacturer's instructions
2. Set the breathing simulator to generate the specified breathing pattern ensuring that the start position is set for “Inhalation” (coordinated) and check that it is operating correctly
3. Connect the spacer/VHC to the test system using a suitable mouthpiece adapter
3. Actuate the MDI whilst simultaneously starting the breath cycle
4. At the end of the test, remove the filter from the holder
5. Repeat the test ensuring that the start position is set for “Exhalation” (uncoordinated) - **VHCs only**.
6. Using a suitable method, determine the amount of active on each filter
7. Determine the ratio of delivered dose for coordinated and uncoordinated use to assess valve efficiency

Representative Tidal Breathing Patterns for MDI with Spacer/VHC Tests

Parameter	Paediatric			Adult	
	Neonate	Infant	Child	Normal 1	Normal 2
Tidal Volume (mL)	25	50	155	770	500
Frequency (cycles/min)	40	30	25	12	13
I/E Ratio	1:3	1:3	1:2	1:2	1:2
Minute Volume (mL)	1000	1500	3875	9240	6500

Delivered Dose Sampling Apparatus for Spacers and VHCs with a Facemask

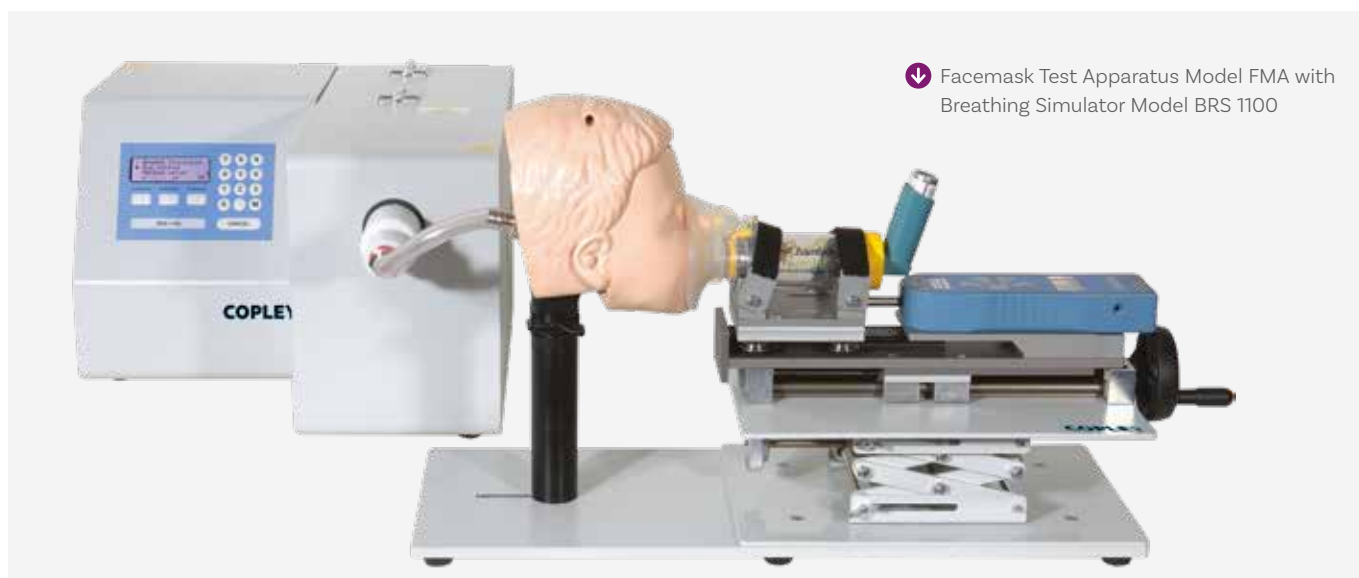

↓ Facemask Test Apparatus Model FMA with Breathing Simulator Model BRS 1100

MASS OF DRUG DELIVERED (With Facemask)

The purpose of the tests described in Section 4.2 is to confirm that the emitted dose from a spacer/VHC used in conjunction with a facemask is comparable to that obtained in the fully coordinated simulation with the facemask removed.

A critical component of the test apparatus is the face model used. This should be appropriate to the age group for which the spacer/VHC is intended, e.g. infant, child or adult.

The face model should be such as to:

1. Achieve realistic dead space and at the same time ensure the absence of leaks between the mask and model
2. Simulate *in vivo* conditions in having physiologically accurate soft facial tissue
3. Provide a means of mounting the spacer VHC such that the facemask is in correct alignment with the face model as in "real-life" conditions

The system from Copley seeks to address all of these requirements, whilst also giving sufficient flexibility to allow users to utilise their own validated face models, if desired.

The Facemask Testing Apparatus (FMA) comprises two key elements:

1. **The Device Securing Fixture.** This secures the spacer/VHC and its associated facemask into position prior to testing.

The device securing fixture has been designed to accommodate various sizes of spacer/VHC. The fixture is adjustable in two axes:

- x (horizontal) and
- y (height)

by means of handwheels.

An in-built digital gauge (Range 0 - 2.5 kg) measures the force applied to the face model in Newtons or kg (e.g. 1.6 kg) as suggested in USP <1602>.

2. The **Face Model Support.** This accepts three different models: infant, child and adult. All models are fitted with replaceable face skins representative of "real-life" tissue.

The support can be adjusted in both axes to tilt the head from front to back or orientate it from side to side.

In this instance, the filter holder is located in a cavity behind the face model's lips.

As for the mouthpiece based product, the specified breathing profile is provided by a breathing simulator, details of which can be found on Page 75.

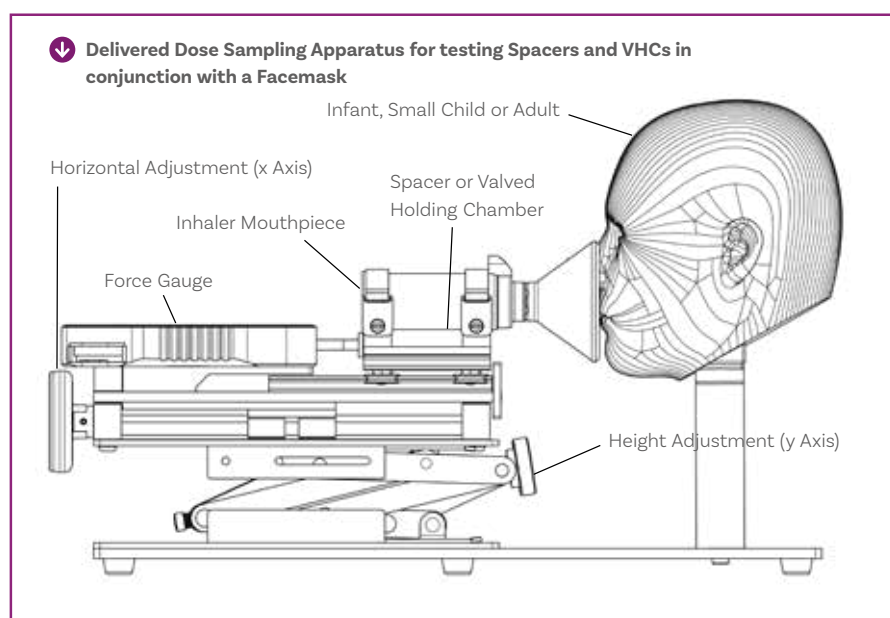



↓ Facemask Test Apparatus Model FMA (with Child Head) shown testing a large spacer

PROCEDURE (With Facemask)

Use a suitable breathing simulator to generate the breathing pattern required in conjunction with the FMA to perform the two tests.

Proceed as follows:

1. Assemble the system as instructed and check that it is air tight using the procedure described in USP chapter <1602>
2. Set the breathing simulator to generate the specified breathing pattern ensuring that the start position is set for "Inhalation" (coordinated) and check that it is operating correctly
3. Connect the spacer/VHC to the system using a suitable mouthpiece adapter
3. Actuate the MDI whilst simultaneously starting the breathing cycle
4. At the end of the test, remove the filter from the holder
5. Repeat the test ensuring that the start position is set for "Exhalation" (uncoordinated) - **VHCs only**
6. Using a suitable method, determine the amount of active on each filter
7. Determine the ratio of delivered dose for coordinated and uncoordinated use to assess valve efficiency

ANCILLARIES

The following ancillaries are required to complete a fully operating test system for the delivered dose testing of spacers and VHCs with a mouthpiece:

- Mouthpiece Adapter (see Page 90)
- Breathing Simulator (See Page 75)

or with a facemask:

- Breathing Simulator (See Page 75)

↓ Filter Holder and Adapter



Cat. No. Description

Mouthpiece-based products

9102	Filter Holder and Adapter for Breath Simulator BRS 1100
9102A	Filter Holder and Adapter for Breath Simulator BRS 2100/3100
9103	Pack of 100 Filters for Filter Holder

Facemask-based products

9141	Facemask Test Apparatus for Spacers & VHCs Model FMA
9142	FMA/FMS Filter Holder and Adapter for BRS 1100
9143	FMA/FMS Filter Holder and Adapter for BRS 2100/3100
9103	Pack of 100 Filters for Filter Holder
9144	Adult Head and Adapter for FMA/FMS
9145	Child Head and Adapter for FMA/FMS
9146	Infant Head and Adapter for FMA/FMS
9147	Re-calibration Certificate for FMA Force Gauge
9152	IQ/OQ Documentation for FMA
9148	FMA Qualification Tools
9153	Re-Calibration of FMA Qualification Tools
9149	Replacement Face Skins for Adult Head (Pack of 6)
9150	Replacement Face Skins for Child Head (Pack of 6)
9151	Replacement Face Skins for Infant Head (Pack of 6)
9005	Compact Printer (Force Gauge)

Aerodynamic Particle Size

Introduction

Together with delivered dose, the Aerodynamic Particle Size Distribution (APSD) is widely recognised as a Critical Quality Attribute (CGA) in the *in vitro* characterisation of OINDPs since it is the APSD of an aerosol cloud that defines where the particles in that cloud are deposited following inhalation.



It is generally accepted, that to be therapeutically effective, the particles should be in the range of 1 to 5 microns. Particles in excess of 5 microns will generally impact in the oropharynx and be swallowed, whereas below 1 micron the possibility exists that the particles will remain entrained in the air stream and be exhaled.

The instrument of choice for measuring the APSD of inhaled products to meet both regulatory and pharmacopoeial requirements alike is the cascade impactor.

This is because:

1. Cascade impactors measure **aerodynamic** particle size (APSD)
2. Cascade impactors measure **active** pharmaceutical ingredient (API)
3. Cascade impactors measure the **entire** dose

Cascade impactors are precision engineered instruments that separate a sample on the

basis of particle inertia (which is a function of velocity and aerodynamic particle size) without the need to know either particle density or shape.

The Pharmacopoeias recommend several commercially available impactors for the routine testing of OINDPs including the **Andersen Cascade Impactor (ACI)** and **Next Generation Impactor (NGI)** both of which are used globally for the testing of MDIs, DPIs and ADIs (Aqueous Droplet Inhalers).

Special versions are available for the testing of nasal delivery systems, nebuliser systems and the add-on devices such as spacers and valved holding chambers sometimes used with MDIs.

Following on from FDA's Guidance on Process Analytical Technology (PAT) in 2004, in the last few years considerable interest has focused on the Quality by Design (QbD) approach to pharmaceutical development and manufacture.

Because of the amount of APSD data required to support QbD, attention has once again turned to faster methods of APSD determination and in particular to the concept of **Abbreviated Impactor Measurement (AIM)**.

In order to meet these demands and to provide a basis for the proof-of-concept work to validate them, Copley has introduced a number of different versions of abbreviated impactors for use in a QbD environment. These are based on reduced stage versions of the ACI and NGI respectively (see Page 62).

Cascade Impactors

INTRODUCTION

The cascade impactor forms the basis of most systems used to measure the size distribution (particle size) of inhaled products.

This is because it has three unique features which currently no other technique can replicate:

1. Cascade impactors measure aerodynamic particle size

Cascade impactors measure aerodynamic particle size which is a function of particle density, as well as the physical dimensions and shape of the particles concerned.

This is important since it helps to explain how particles behave in a moving air stream (as exemplified by the respiratory tract) as opposed to simple “geometric” size.

2. Cascade impactors measure active pharmaceutical ingredient

Cascade impactors provide a direct means of recovering and quantifying the active pharmaceutical ingredient (API) contained in the aerosol cloud as opposed to the overall formulation.

This is important since the aerosol clouds generated by pharmaceutical inhalers typically comprise a combination of API(s) and other excipients or components, the latter having no effect on therapeutic efficacy.

3. Cascade impactors measure the entire dose

Cascade impactors, unlike other techniques which just provide a snap-shot of part of the dose, capture the entire dose allowing complete characterisation of the formulation under test.

IMPACTOR SYSTEMS

In its simplest form, an inhaler particle sizing system comprises the following components:

- Mouthpiece Adapter (see Page 90)
- Induction Port (Throat)
- Cascade Impactor
- Vacuum Pump (see Page 91)

The **cascade impactor** itself consists of one or more stages normally arranged in the form of a “stack”, which can be vertical or horizontal. These separate the particles entrained in the aerosol stream, passing through them into a series of size bands or fractions, broadly corresponding to their likely deposition sites in the respiratory tract.

For most inhaler related applications, the entrance to the impactor is fitted with a right angled induction port designed to act as a throat. The dimensions of this **induction port** have now been standardised between the various Pharmacopoeias and serve to ensure that the aerosol cloud produced by the inhaler is sampled in a reproducible manner.

The inhaler is connected to the induction port by means of a **mouthpiece adapter** which provides an airtight seal between the induction port and the medical device under test.

Once discharged from the inhaler, the aerosol cloud is drawn through the impactor by means of a **vacuum pump** connected to the outlet of the impactor by a suitable length of tubing.



↑ Anderson Cascade Impactor (28.3 L/min Version) with USP Induction Port

↓ Mouthpiece Adapters

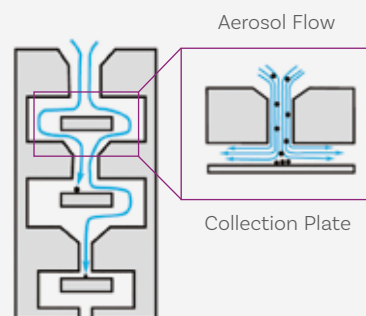

↑ Principle of Operation

Cascade Impactors

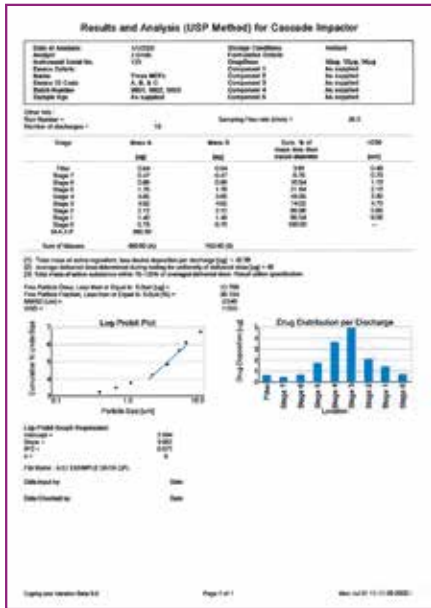

↑ Typical Data Analysis from a Cascade Impactor

PRINCIPLES OF OPERATION

Cascade impactors operate on the principle of **inertial impaction**. Each stage of the impactor comprises a single or series of nozzles or jets through which the sample laden air is drawn, directing any airborne particles towards the surface of the collection plate for that particular stage.

Whether a particular particle impacts on that stage is dependent on its aerodynamic diameter. Particles having sufficient inertia will impact on that particular stage collection

plate, whilst smaller particles with insufficient inertia will remain entrained in the air stream and pass to the next stage where the process is repeated.

The stages are normally assembled in a stack in order of decreasing particle size. As the jets get smaller, the air velocity increases and finer particles are collected. Any remaining particles are collected on an after-filter (or by a Micro-Orifice Collector [MOC]).

At the end of the test, the particle mass relating to each stage collection plate is recovered using a suitable solvent and then analysed, usually using HPLC to determine the amount of drug actually present.

By analysing the amount of drug deposited on the various stages in this manner, it is then possible to calculate the Fine Particle Dose (FPD) and Fine Particle Fraction (FPF) and, following further manipulation, the Mass Median Aerodynamic Distribution (MMAD) and Geometric Standard Deviation (GSD).

Factors affecting impaction

• Bounce/Re-entrainment

In some instances, particles may bounce as opposed to impact when they contact the collection plate, in which case they are normally re-entrained into the air stream and carried to a lower stage, ultimately collecting on the wrong stage further downstream. This can be a particular problem with DPIs and certain MDIs (where measurements are based on a limited number of actuations from the inhaler or in the absence of a surfactant).

This tendency may be avoided by coating the collection plates with a suitable surface coating, e.g. glycerol or silicone oil.

• Inter-Stage Losses

Particle deposition on impactor parts other than the designated collection plates or cups.

Terminology

The **Fine Particle Dose (FPD)** may be defined as the quantity of drug in the prescribed dose that is generally considered to be of a size capable of penetrating the lung during inhalation i.e. respirable. This is usually considered to be 5 microns or less.

The **Fine Particle Dose (FPD)** should not be confused with **Fine Particle Mass (FPM)** which is the quantity of drug to be found in one actuation of the device, since the prescribed dose may comprise more than one actuation.

The **Fine Particle Fraction (FPF)** is the FPD expressed as a percentage of the delivered dose (the dose that leaves the inhaler device and is available to the patient).

The term **“impactor”** is generally used for an instrument where the particles “impact” on a dry impaction plate or cup. If the collection surface is liquid, as in the case of the Multi-Stage Liquid Impinger (MSLI), then the term **“impinger”** is used. The general principles of inertial impaction apply to both “impactors” and “impingers”.

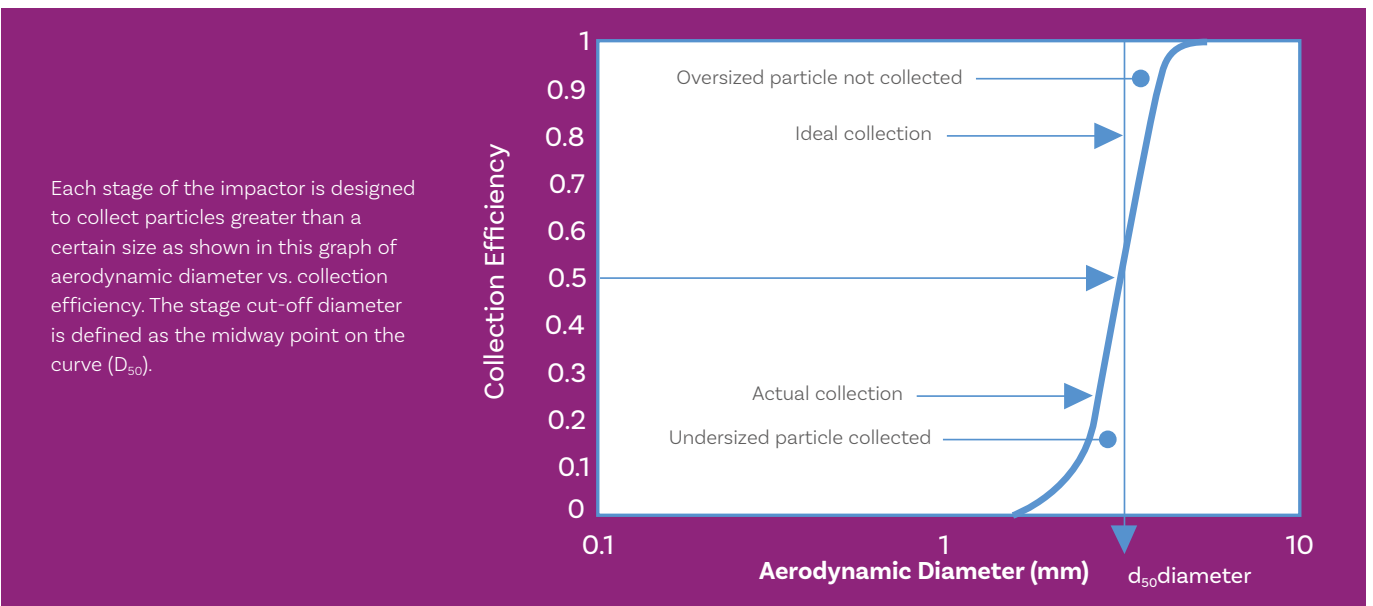

Each stage of the impactor is designed to collect particles greater than a certain size as shown in this graph of aerodynamic diameter vs. collection efficiency. The stage cut-off diameter is defined as the midway point on the curve (D_{50}).

Choosing an Impactor or an Impinger for Testing MDIs and DPIs

Andersen Cascade Impactor (ACI)
(Aluminium, 316 Stainless Steel
and Titanium)



Glass Twin Impinger →



INTRODUCTION

Between them the Ph.Eur. and USP list no less than five different cascade impactors/impingers suitable for the aerodynamic assessment of fine particles.

However, only the **Andersen Cascade Impactor (ACI)**, the **Next Generation Impactor (NGI)** and the **Multi-Stage Liquid Impinger (MSLI)** appear in both Pharmacopoeias.

When selecting an impactor, much will depend on the product to be tested, the data that is required, the geographical location where the product is to be marketed and whether the unit is to be used for product development or quality control.

In research applications, *in vitro* - *in vivo* correlation (IVVC) and bioequivalence may be important and so detailed particle size data may be required.

In routine quality control, where the concern is batch-to-batch variation, a coarser test may be acceptable.

The two-stage **Glass Twin Impinger**, for example, has been retained as Apparatus A in the Ph.Eur., because of its value as a simple and inexpensive quality control tool.

In general however, it is accepted that an impactor/impinger should have a minimum

of five stages and preferably more, if it is to provide detailed particle size distribution data.

Andersen Cascade Impactor (ACI)

The ACI is arguably the most commonly used impactor within the pharmaceutical industry for the testing of inhaled products.

The 8-stage ACI was originally developed as a bacteriological air sampler and then adopted by the pharmaceutical industry for inhaler testing. Many drug applications are based on data collected from the ACI due to its longevity within the industry.

A number of papers published in the late 1990s highlighted concerns relating to the manufacture and performance of the ACI manufactured by Graseby-Andersen between 1992 and 1998.

These focused on the choice of material used in their construction, ease of use, accuracy, calibration and the ability to suitably qualify the impactors prior to use.

Because of these criticisms, **Copley** commenced manufacturing their own Andersen Cascade Impactor using the latest state-of-the-art production techniques.

The combination of improved manufacturing techniques and QC test procedures has resolved the manufacturing variability

previously associated with the ACI, restoring full confidence in its use.

The advantages of the ACI may be summarised as follows:

- Well established and readily accepted by the regulatory authorities
- A total of 8 individual stages between 0.4 and 9 microns
- Choice of aluminum, 316 stainless steel or titanium
- 60 and 90 L/min Conversion Kits available for high flow rate testing, whilst retaining the 28.3 L/min cut-off diameters
- Low flow resistance at high flow rates when Stages 6 & 7 are removed
- Small footprint where laboratory space is limited
- Reduced stack option for work with nasal aerosols and sprays
- Easy removal and replacement of damaged and non-conforming stages
- Low cost

Choosing an Impactor or Impinger for Testing MDIs and DPIs



Next Generation Impactor (NGI) with Induction Port and Preseparator

Multi-Stage Liquid Impinger (MSLI) in Aluminium, 316 Stainless Steel and Titanium

Next Generation Impactor (NGI)

In 1997, a group of prominent pharmaceutical companies involved in the development and manufacture of inhalers formed a consortium to develop a new impactor specifically designed for testing pharmaceutical inhalers.

The task of designing the new impactor was given to Virgil Marple and his team (MSP Corporation, USA) due to his globally renowned expertise in cascade impactor design.

The result, the NGI, was launched in 2000. Both design and subsequent archival calibration are documented to pharmaceutical standards.

The NGI is a high performance, precision, particle classifying cascade impactor having seven stages plus a Micro-Orifice Collector (MOC).

In practice, its flexibility of use and high productivity are making the NGI the new “workhorse” within many inhaler research laboratories.

Correlation studies between ACI and NGI show good agreement between particle size distributions although this does not necessarily mean they are interchangeable for all inhalers.

Main features of the NGI include:

- Designed by the pharmaceutical industry for the pharmaceutical industry
- Operates between 15 and 100 L/min
- 7 stages (5 out of the 7 always between 0.54 and 6.12 microns)
- Easy drug recovery with low inter-stage losses
- High stage efficiency: $500 < Re < 3000$ for all stages
- 3-part construction lends itself to semi- and full-automation
- Documented and published design and archival calibration

Multi-Stage Liquid Impinger (MSLI)

The MSLI was the first cascade impactor/impinger specifically designed for inhaler testing.

Whilst the 4-Stage MSLI does not offer the number of stages of the ACI or NGI, it does, by definition, have no inter-stage losses and is suitable throughout the range 30-100 L/min.

Unlike the ACI and NGI, the collection stages of the MSLI are kept moist, which eliminates

the problem of particle bounce associated with conventional impactors.

Advantages include:

- 4 Stages between 1.7 and 13 microns
- Operates between 30 and 100 L/min
- Virtually no inter-stage losses
- Eliminates particle bounce and hence re-entrainment problems
- Choice of aluminum, 316 stainless or titanium construction
- Easy and quick drug recovery

Other Impactors

The following impactor is also worthy of mention and is described in more detail later in the brochure:

- **Glass Twin Impinger** (page 55)

Andersen Cascade Impactor (ACI)

↓ Schematic of ACI with Pump for testing MDIs

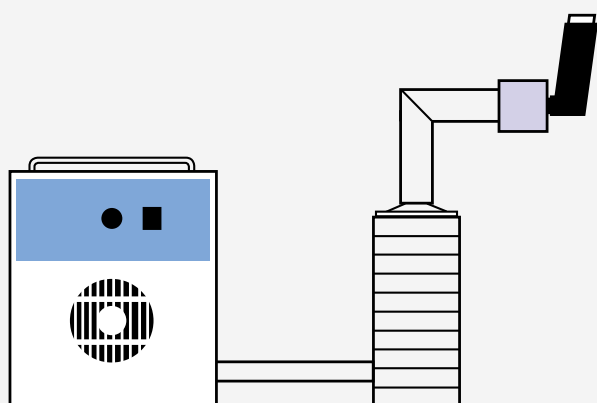

↓ ACI with Pump for testing MDIs



INTRODUCTION

The ACI, manufactured by Copley, is an 8-stage cascade impactor that has been designed for measuring the APSD generated by MDIs and DPIs.

It complies with the specifications laid down in USP Chapter <601>, Ph.Eur. 2.9.18 and ChP 2015.

IMPACTOR USE (METERED-DOSE INHALERS)

The standard ACI is designed for use at 28.3 L/min (which is equivalent to 1 cubic foot/min).

The 8 stages have the following particle size collection bands:

- Stage 0 9.0 + microns
- Stage 1 5.8 – 9.0 microns
- Stage 2 4.7 – 5.8 microns
- Stage 3 3.3 – 4.7 microns
- Stage 4 2.1 – 3.3 microns
- Stage 5 1.1 – 2.1 microns
- Stage 6 0.7 – 1.1 microns
- Stage 7 0.4 – 0.7 microns

The ACI, like other cascade impactors, is designed such that as the aerosol stream passes through each stage, particles having sufficient inertia will impact upon that

particular stage collection plate, whilst smaller particles with insufficient inertia will remain entrained in the air stream and pass to the next impaction stage.

By analysing the amount of active drug deposited on the various stages, it is then possible to calculate the Fine Particle Dose (FPD) and Fine Particle Fraction (FPF) and following further manipulation, the Mass Median Aerodynamic Distribution (MMAD) and Geometric Standard Deviation (GSD) of the active drug particles collected.

IMPACTOR USE (DRY POWDER INHALERS)

The same impactor can be used for determining the particle size of Dry Powder Inhalers (DPIs).

In this instance, however, a **preseparator** is interposed between the induction port and stage 0 of the impactor in order to collect the large mass of non-inhalable powder boluses typically emitted from a DPI prior to their entry into the impactor.

In the case of Dry Powder Inhalers (DPIs), a number of additional factors must be taken into account when testing:

- The pressure drop generated by the air drawn through the inhaler during inspiration
- The appropriate flow rate, Q, to give a pressure drop of 4 kPa
- The duration of simulated inspiration to give a volume of 4 litres
- Flow rate stability in terms of critical (sonic) flow

These factors require the use of the “General Control Equipment” for DPIs specified in USP chapter <601> and “Experimental Set Up” for testing DPIs in Ph.Eur. 2.9.18 which take all of these factors into account.

These specifications form the basis of the Critical Flow Controllers (see Page 80) which incorporate all of the equipment required into a single integrated system.

Andersen Cascade Impactor (ACI)

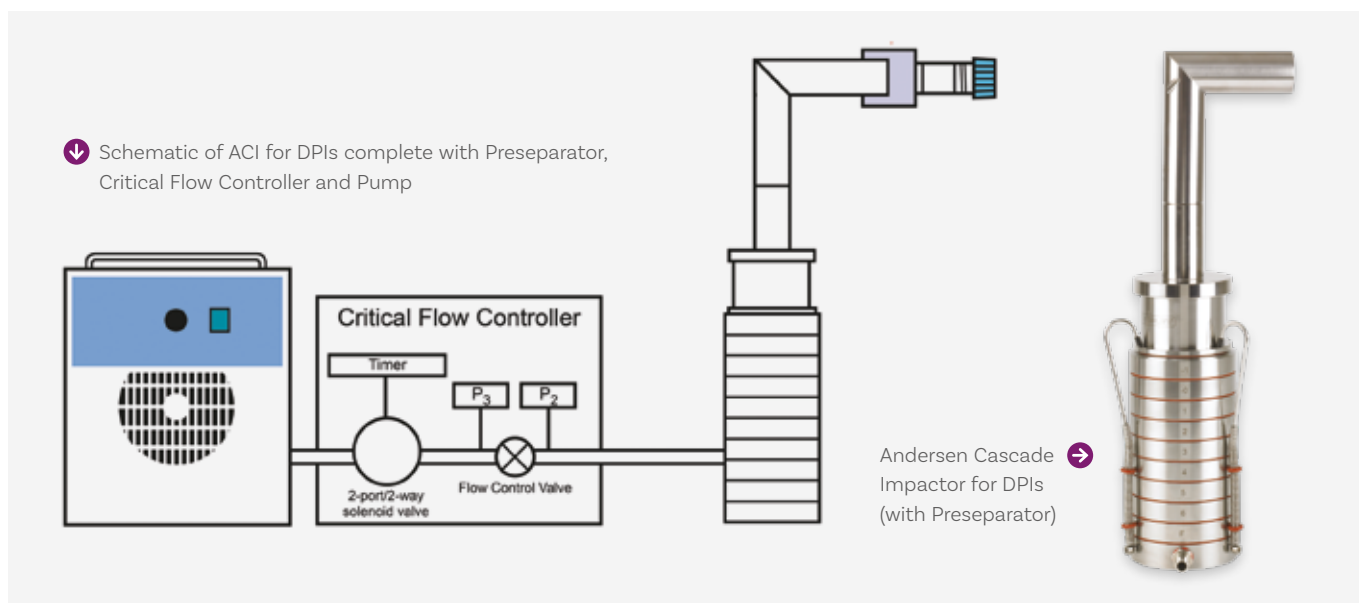

MODIFIED CONFIGURATIONS FOR USE AT 60 AND 90 L/MIN

In many cases (particularly with low resistance DPIs), it is necessary to operate at flow rates greater than 28.3 L/min, if a pressure drop over the inhaler of 4 kPa is to be achieved.

Whilst the ACI can be operated at flow rates greater than 28.3 L/min, it is important to consider the change in cut-points that will occur for each stage. An empirical equation can be used to calculate these cut-point changes over the range of 28.3 - 100 L/min. However, the user should be aware that reduced discrimination between the

cut-points will occur as the flow rate is increased. Furthermore, the validity of the empirical equation becomes questionable, the further the test flow rate deviates from 28.3 L/min.

In order to help address these problems, two modified configurations of the ACI are available for operating at flow rates of 60 and 90 L/min. These are described in USP Pharmacopoeial Forum Volume 28, Number 2, 2002, p. 601-603 and are now enshrined in USP chapter <601>.

In the 60 L/min version, stages 0 and 7 are removed and replaced with two additional stages, -0 and -1. Similarly, in the 90 L/min

version, stages 0, 6 and 7 are removed and replaced with three additional stages, -0, -1 and -2.

Changes are also made to the configuration of the collection plates (with and without centre holes).

This results in a set of cut-points as per the table below.

QUALITY

A number of papers published in the late 1990s highlighted concerns relating to the manufacture and performance of the ACI manufactured by Graseby-Andersen between 1992 and 1998.

These focused on the choice of material used in their design, their construction, ease of use, accuracy, calibration and the ability to suitably qualify the impactors prior to use.

Because of these criticisms, Copley commenced manufacturing the ACI using the latest state-of-the-art production techniques.

These techniques ensure that 100% of the jets of every stage of every Copley impactor conform to the published critical dimensions for the ACI stated in USP Chapter <601> and Ph.Eur. Chapter 2.9.18.

The validity of this data is guaranteed by dimensional verification using the very latest vision inspection technology having a demonstrated optical reproducibility of 1 micron (to a 99% confidence interval).

Cut-off Diameter at	28.3	60	90	L/min
• Stage -2	-	-	8.0	microns
• Stage -1	-	8.6	6.5	microns
• Stage -0	-	6.5	5.2	microns
• Stage 0	9.0	-	-	microns
• Stage 1	5.8	4.4	3.5	microns
• Stage 2	4.7	3.2	2.6	microns
• Stage 3	3.3	1.9	1.7	microns
• Stage 4	2.1	1.2	1.0	microns
• Stage 5	1.1	0.55	0.22	microns
• Stage 6	0.7	0.26	-	microns
• Stage 7	0.4	-	-	microns

Andersen Cascade Impactor (ACI)



MATERIALS OF CONSTRUCTION

The ACI was originally designed for environmental air sampling and is traditionally constructed from aluminium. However its adoption by the pharmaceutical industry has placed far harsher demands on the material because of the use of organic solvents in the drug recovery process.

Recent advances in automated, high precision machining techniques now mean that the ACI can be manufactured from **316 stainless steel** (the pharmaceutical industry's preferred material) and also **titanium**.

The main advantage of 316 stainless steel is that of superior corrosion resistance and durability, meaning that 316 stainless steel impactors manufactured by Copley are not only very competitively priced but also highly cost effective, helping to maintain accuracy and extend impactor life by reducing mechanical and chemical wear. Electrically conductive, stainless steel can also help reduce the unwanted effects of electrostatics in the impactor.

Where the weight of 316 stainless steel is a concern, Copley can also offer titanium, which has the durability of 316 stainless steel but with a 40% reduction in weight.

Copley continues to offer aluminium ACIs for those users who prefer a lower cost option or for those cases where their methods are such that corrosion resistance and durability

are not an issue. Leak-free inter-stage sealing is achieved through the use of high quality **FDA approved silicone rubber O-rings**.

Preseparators feature a one-piece seamless construction and, together with the induction ports, come with mensuration certificates as standard.

All collection plates are manufactured from 316 stainless steel. They are individually inspected for surface roughness and laser etched on the underside with batch number for traceability.

Also available as options are a one-piece 316 stainless steel induction port and specially modified 'O-ring free' 316 stainless steel inlet cone and preseparator lids for accepting the NGI style induction port.

EASE OF USE

The "**Quick Clamp**" is an optional accessory for use with the ACI which can also be retrofitted to existing impactors.

Constructed from stainless steel, the "Quick Clamp" provides a quick and easy means of assembling, clamping and dis-assembling all or part of the impactor stack (for example, less stages 6 and 7) during routine operation.

Once the assembled stack is in position, the clamping action is achieved very simply by turning a small knob through 90 degrees.

* Rounded to 0.013 in the case of USP

Andersen Cascade Impactor (ACI) - Standard 28.3 L/min Configuration

Stage Number	Nozzles	Ph.Eur. Nozzle Diameter (mm)
0	96	2.55 +/- 0.025
1	96	1.89 +/- 0.025
2	400	0.914 +/- 0.0127*
3	400	0.711 +/- 0.0127*
4	400	0.533 +/- 0.0127*
5	400	0.343 +/- 0.0127*
6	400	0.254 +/- 0.0127*
7	201	0.254 +/- 0.0127*

Andersen Cascade Impactor (ACI)



↑ ACI Carrying / Wash Rack

↑ Andersen Cascade Impactor (Aluminium, 316 Stainless Steel and Titanium)

MENSURATION, QUALIFICATION AND SYSTEM SUITABILITY

Every impactor manufactured by Copley is machined to the same precision tolerances in order to guarantee reproducibility between impactors and to ensure stage mensuration.

Stage mensuration replaces the need for repetitive calibration using standardised aerosols and ensures that only impactors conforming to specification are used in testing.

In practice, this means that every jet on every stage of every impactor must be individually inspected to ensure compliance.

For this reason, all cascade impactors (including induction ports and preseparators), manufactured by Copley, are checked at

every stage of manufacture using the very latest in **metrology equipment** and are provided with a **mensuration certificate** and **leak test certificate** prior to release.

SUMMARY

ACIs manufactured by Copley are:

- Available in aluminium, 316 stainless steel or titanium
- Capable of operation at 28.3, 60 or 90 L/min
- Manufactured to USP and Ph.Eur. critical dimensions
- Supplied with full stage mensuration certificate, certificate of conformity to USP/Ph.Eur. and leak test certificate

ANCILLARIES

The following ancillaries are required in addition to the ACI to complete a fully operating test system for determining the APSD of MDIs:

- Mouthpiece Adapter (see Page 90)
- Induction Port (see Page 49)
- Vacuum Pump (see Page 91)
- Flow Meter (see Page 88)
- Data Analysis Software (see Page 94)

Additionally to test DPIs:

- Preseparator (see Page 49)
- Critical Flow Controller (see Page 80)

Options:

- Automation (see Page 113)



← Modified 28.3 and 60 L/min Preseparator Lids (Cat. No. 8421/8422) and Inlet Cone (Cat. No. 8366) for use with NGI Induction Port (Cat. No. 5203)



↑ Quick Clamp



↑ ACI Collection Plate Rack



↑ ACI Collection Plates
(featuring batch numbering)



↑ Preseparator, 60 L/min Conversion Kit
and Collection Plates

Cat. No. Description

Impactors

8301	28.3 L/Min Andersen Cascade Impactor*
8301-60	60 L/Min Andersen Cascade Impactor*
8301-90	90 L/Min Andersen Cascade Impactor*

Induction Ports

8501	USP Induction Port*
8510	USP Induction Port (One-piece 316 Stainless Steel)
8060	Flow Meter to Induction Port/WSC2 Adapter

Preseparators for testing DPis

8401	28.3 L/min Preseparator*
8420	60 L/min Preseparator*
8420-90	90 L/min Preseparator*

Conversion Kits for the standard 28.3 L/min ACI

8318	Conversion Kit for 60 L/min operation*
8319	Conversion Kit for 90 L/min operation*

Options

8111	Stand (incl. Base Plate, Boss Head and Clamp)
5212	'Quick Clamp' for Andersen Cascade Impactor
5401	ACI Carrying/Wash Rack
5441	ACI Collection Plate Rack

Spare Parts

8307	Complete Set of 13 ACI Silicone Rubber O-Rings
8314	Set of 8 Stainless Steel Collection Plates (28.3 L/min)
8314-60	Set of 8 Stainless Steel Collection Plates (60 L/min)
8314-90	Set of 8 Stainless Steel Collection Plates (90 L/min)
8316	Box of 100 Glass Fibre Filters
8306	Set of 6 O-Rings for Spring Clamp
8308	Set of 3 Spring Clamps
8309	Set of 3 PVC End Caps for Spring Clamps
8403	Set of 4 O-Rings for Preseparator
8395	ACI Carrying Case
8351	Inlet Cone*
8352	Stage -2A*
8353	Stage -1A (for 90 L/min operation)*
8354	Stage -1 (for 60 L/min operation)*
8355	Stage -0*
8356	Stage 0*
8357	Stage 1*
8358	Stage 2*
8359	Stage 3*
8360	Stage 4*
8361	Stage 5*
8362	Stage 6*
8363	Stage 7*
8364	Stage F (Filter)*
8365	Base (including Hose Fitting)*

*Please specify **Aluminium (A)**, **316 Stainless Steel (S)** or **Titanium (T)** when placing your order.

Next Generation Impactor (NGI)



INTRODUCTION

Before the introduction of the NGI, the Andersen Cascade Impactor (ACI) was the main impactor used by the pharmaceutical industry.

Although originally designed for microbial sampling, the ACI is a well-established instrument that has served the industry well. It remains in widespread use and is expected to remain so in the foreseeable future. Because of its air sampling origins however, the ACI does suffer from certain drawbacks and it is not easy to automate.

In developing the NGI, the consortium involved drew on their extensive experience

to come up with a list of “musts” and “wants” for the new impactor.

The result, the NGI, is an impactor with the following features:

- Designed by the pharmaceutical industry for inhaler testing
- Meets and exceeds all Ph.Eur. and USP specifications
- Particle size range: 0.24 – 11.7 microns (dependent on flow rate)
- Seven stages; five with cut-offs between 0.54 and 6.12 microns at flow rates from 30 to 100 L/min
- Excellent stage efficiency, accuracy and reproducibility

- Archival calibrated flow rate range: 30 – 100 L/min
- Additional calibration at 15 L/min for nebuliser applications
- Supplied with full stage mensuration report (system suitability)
- Low inter-stage wall losses for good drug recovery (mass balance)
- User friendly design for maximum throughput and easy automation
- Electrically conductive; unaffected by static
- Design and archival calibration formally documented and published

Cut-off Diameters at	15	30	60	100	L/min
Stage 1	14.10	11.72	8.06	6.12	microns
Stage 2	8.61	6.40	4.46	3.42	microns
Stage 3	5.39	3.99	2.82	2.18	microns
Stage 4	3.30	2.30	1.66	1.31	microns
Stage 5	2.08	1.36	0.94	0.72	microns
Stage 6	1.36	0.83	0.55	0.40	microns
Stage 7	0.98	0.54	0.34	0.24	microns

DESCRIPTION

The initial design considerations concentrated on the number of stages and basic layout. Seven stages were finally specified to give five with cut-off diameters in the 0.5 - 5 micron range and a horizontal planar layout adopted for ease of operation and automation.

The cut-off diameters for the relevant stages at volumetric flow rates of 15, 30, 60 and 100 L/min are shown left.

The air flow passes through the impactor in a saw tooth pattern. Particle separation and sizing is achieved by successively increasing the velocity of the airstream as it passes through each by forcing it through a series of nozzles containing progressively reducing jet diameters.

The impactor itself comprises just **three main parts**:

1. The cup tray containing the eight collection cups used to collect the samples prior to analysis
2. The bottom frame used to support the cup tray
3. The lid containing the inter-stage passageways and the seal body which holds the nozzles in place

In routine operation, the three parts are held together using the handle clamping mechanism. Each circular nozzle assembly

(stage) is held above a tear-shaped cup in a single seal body

The feasibility of incorporating **removable nozzles** was considered at some length by the consortium but it was decided that this was not possible without compromising impactor integrity. The current fixed design gives confidence in the jet-to-plate distance – a major determinant of capture efficiency. Perhaps more importantly, it completely eliminates the high levels of risk associated with removable nozzles being replaced in the wrong position.

A removable tray holds all the sample cups such that they can be removed and/or replaced in one single operation. Low inter-stage losses and minimal particle carryover mean that only the cups and tray need changing between tests. Most NGI users benefit from multiple sets of cups with a single impactor in order to maximise productivity.

At either end, the NGI has two larger cups that collect from Stage 1 and, the **Micro-Orifice Collector (MOC)** respectively.

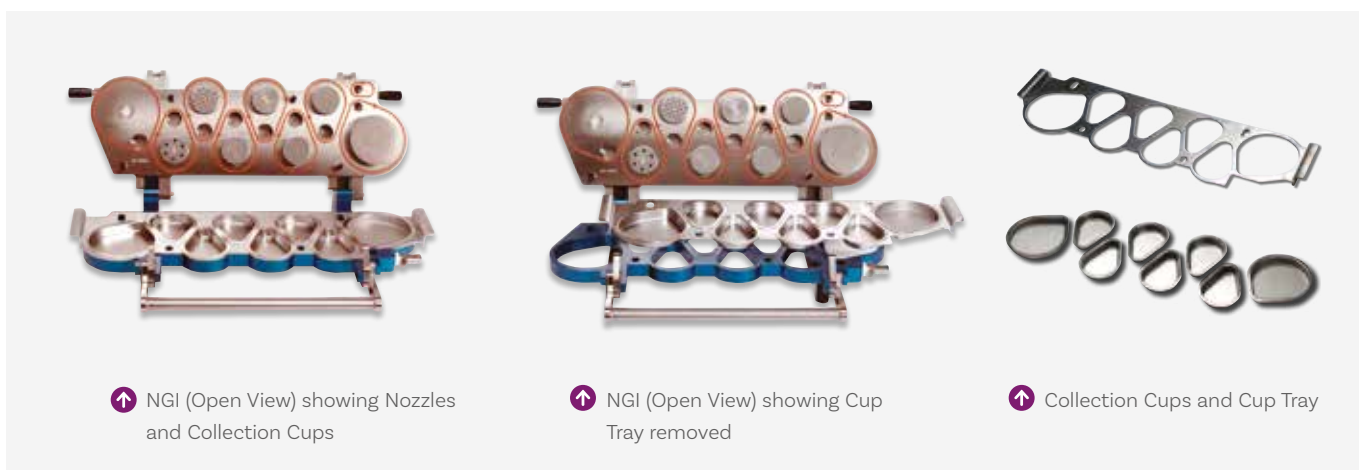

Next Generation Impactor (NGI)



The large cup used in Stage 1 minimises large particle impaction on the walls of that particular stage.

Whilst not a particle classifying stage in its own right, the MOC has 4032 jets each approx. 70 microns in diameter and is capable of 80% collection efficiency of 0.3 micron particles (at 30 L/min) thus, in most cases, eliminating the need for a final filter paper.

However, if ultra-fine particles are present, as for example in solution MDIs, then an **Internal** or **External Filter Holder** can be used to collect these particles in the conventional manner.

The **NGI Induction Port** is manufactured from 316 stainless steel. The tapered and hardened outlet provides an airtight seal with the inlet to Stage 1 without the use of O-Rings whilst retaining the critical internal dimensions stated in Ph.Eur. and USP.

As with other impactors, the NGI requires the use of a preseparator when used with DPIs in order to catch any powder boluses and large non-inhalable particles.

The **NGI Preseparator** is a high capacity, high efficiency, two-stage preseparator with a

sharp and reproducible cut-point of between 10 and 15 microns depending on flow rate.

Four special types of sample collection cup are available in addition to those supplied as standard with the NGI:

- Gravimetric Cup (for APSD determinations based on weight)
- Deep Cup (to bypass a stage, obviating impaction)
- Exhaust Cup (to bypass downstream portion of impactor)
- Glass Disc Cup (for Malvern Morphologi G3-ID system tests)

The NGI measures approx. 500 mm (L) x 160 mm (W) x 300 mm (H) (including induction port and preseparator).

Further details regarding the design and archival calibration of the NGI can be found in the Journal of Aerosol Medicine Volume 16(3), 2003 and Volume 17(4), 2004.

PROCEDURE

1. Open the hinged lid of the NGI using the quick-release handle

2. Place a fresh set of collection cups (coated as required) into a cup tray and locate the tray in the bottom frame of the impactor

3. Close the impactor and perform a leak test (if necessary)

4. Attach the preseparator (if required), with 15 mL of solvent dispensed into the insert cup, and the induction port to the inlet of the NGI

5. Connect a suitable vacuum pump to the outlet of the NGI and set the required inlet flow with a flow meter

6. Connect the inhaler to the induction port using a mouthpiece adapter and actuate the required dose(s)

7. Remove the inhaler, throat and preseparator (if used) and recover the samples from these components using a suitable solvent

8. Open the impactor, remove the cup tray and add solvent to each of the cups. Agitate gently before assaying the contents using a suitable method

9. The impactor is now ready for another test

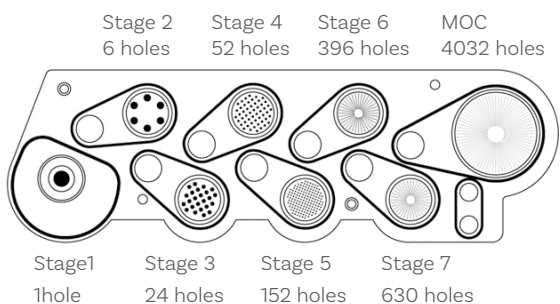

↑ Schematic of Seal Body showing orientation of the various stages

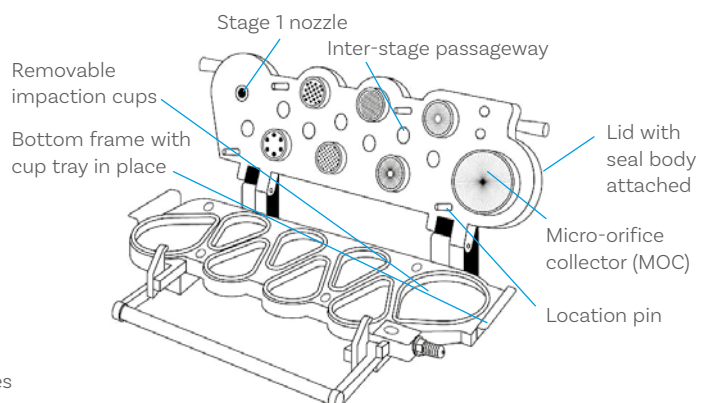



ANCILLARIES

The following ancillaries are required in addition to the NGI to complete a fully operating test system for determining the APSD of MDIs:

- Mouthpiece Adapter (see Page 90)
- Induction Port (Page 53)
- Vacuum Pump (see Page 91)
- Flow Meter (see Page 88)
- Data Analysis Software (see Page 94)

Additionally to test DPIs:

- Preseparator (see Page 53)
- Critical Flow Controller (see Page 80)

Options:

- Automation (see Page 113)

Cat. No. Description

Impactors

5201 Next Generation Impactor (NGI)

Induction Ports

5203 NGI Induction Port

8060 Flow Meter to Induction Port/WSC2 Adapter

Preseparators for testing DPIs

5204 NGI Preseparator (Nickel Plated Aluminium)

5204A NGI Preseparator with Stainless Steel Insert

Accessories

5205 NGI Carrying/Wash Rack

5206 Internal Filter Holder

5210 External Filter Holder

5222 NGI Collection Cup Rack

5240 Box of 100 Filters (for Internal/External Filter Holder)

5241 Gravimetric Cup Small (for APSD determinations based on weight)

5241A Pack of 100 Filters for Small Gravimetric Cup

5244 Gravimetric Cup Large (for APSD determinations based on weight)

5243A Deep Cup, Small (to bypass a stage, obviating impaction)

5242A Malvern Glass Disc Cup, Small (for Morphologi G3-ID system)

5243 Exhaust Cup, Small (to bypass downstream stages of impactor)

5254 NGI Transportation Case

Spare Parts

5208 Collection Cup Tray

5209 Set of 8 Collection Cups (2 Large, 6 Small)

5245 Welded Cup Tray Manifold

5211 Set of 18 Seals for the Next Generation Impactor

5246 Set of 10 Seals for the NGI Preseparator

5247 Set of 10 Seals for the NGI Internal Filter Holder

5248 Set of 10 Seals for the NGI External Filter Holder

5249 NGI Outlet Diameter Reducing Adapter

Multi-Stage Liquid Impinger (MSLI)

DESCRIPTION

The MSLI is a versatile **four-stage** liquid impinger which can be used for determining the APSD of DPIs in the case of USP Chapter <601> and of MDIs and DPIs in the case of Ph.Eur. Chapter 2.9.18.

The MSLI is available in a range of materials: **aluminium, 316 stainless steel** or **titanium**. This choice allows flexibility in terms of corrosion resistance, weight and cost. The MSLI is fitted with PTFE seals as standard.

The design is such that at a flow rate of 60 L/min, the cut-off diameters of Stages 1, 2, 3 and 4 are 13, 6.8, 3.1 and 1.7 microns respectively. Stage 5 comprises an integral paper filter to capture the remaining fraction of particles less than 1.7 microns.

The MSLI has, by definition, no inter-stage losses and is suitable for use throughout the range **30 - 100 L/min**.

Unlike the ACI and NGI, the collection stages of the MSLI are kept moist which helps to reduce the problem of re-entrainment sometimes experienced when using more

conventional impactors. It employs the same induction port as the other cascade impactors.

A stage mensuration certificate and leak test certificate are included with each MSLI as standard. During the mensuration, the sintered glass impingement stages are positioned using calibrated gauge blocks to ensure that the correct jet-to-plate distance is maintained.

ANCILLARIES

The following ancillaries are required in addition to the MSLI to complete a fully operating test system for determining the APSD of MDIs:

- Mouthpiece Adapter (see Page 90)
- Induction Port (see Page 54)
- Vacuum Pump (see Page 91)
- Flow Meter (see Page 88)
- Data Analysis Software (see Page 94)

Additionally to test DPIs:

- Critical Flow Controller (see Page 80)



Multi-Stage Liquid Impinger (MSLI)

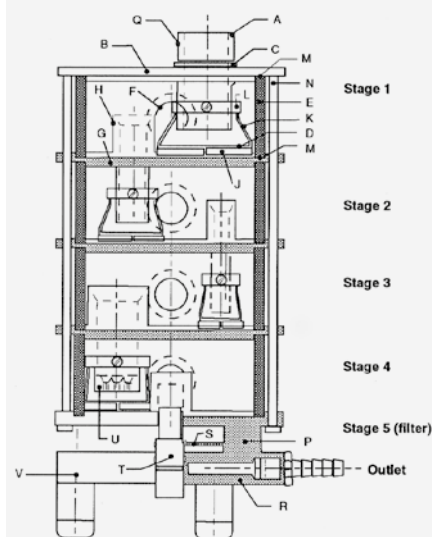

Schematic of Multi-Stage Liquid Impinger (MSLI)

Cat. No. Description

8801	Multi-Stage Liquid Impinger (MSLI)*
8501	USP Induction Port*
8510	USP Induction Port (One-piece 316 Stainless Steel)
8060	Flow Meter to Induction Port/WSC2 Adapter

Options

8111	Stand (incl. Base Plate, Boss Head and Clamp)
8851	Torque Adjuster for MSLI

Spare Parts

8805	Set of 3 O-Rings
8807	Set of 8 Inter-Stage PTFE Gaskets (Code M)
8814	Filter Support Plate (Code S)
8834	Pack of 10 Silicone Rubber Stoppers
8839	Pack of 100 Glass Fibre Filters
8840	Ground Glass Cylinder (Code E)
8844	Set of 4 Sintered Glass Discs (Code D)

* Please specify Aluminium (A), 316 Stainless Steel (S) or Titanium (T) when placing your order.

Glass Twin Impinger (GTI)

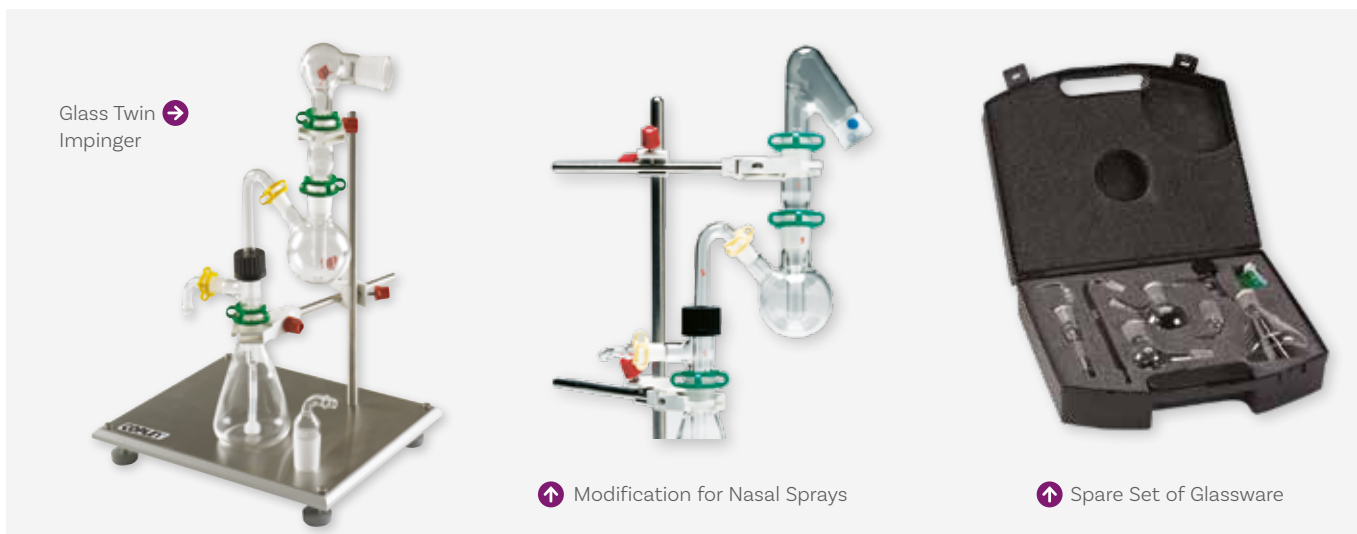

DESCRIPTION

The value of the GTI, particularly with respect to routine quality control applications, is recognised by its retention as Apparatus A in Ph.Eur. 2.9.18 and Apparatus 1 in ChP 2015.

Its usage is restricted to the assessment of nebulisers, MDIs and such DPIs where it can be demonstrated that a flow rate of 60 (+/- 5) L/min is suitable.

The major advantage is that it is manufactured solely from glass so that it is not prone to corrosion in the same way as conventional metallic impactors.

The GTI comes complete with stainless steel base plate, stand, clamp and boss head in

addition to plastic clips to retain the glass parts in position and is supplied with a mensuration certificate confirming that the critical dimensions conform to those stated in Ph.Eur.

It operates on the principle of liquid impingement to divide the dose emitted from the inhaler into respirable and non-respirable portions.

The upper impingement chamber (stage 1) is designed such that at a flow rate of 60 L/min through the impinger, the particle cut-off is **6.4 microns**. Particles smaller than 6.4 microns pass into the lower impingement chamber (stage 2).

Prior to testing, 7 mL of solvent is typically dispensed into the upper impingement chamber and 30 mL to the lower impingement chamber. After the test is complete, the active drug collected in the lower impingement chamber is assayed and expressed as a respirable fraction (or percentage) of the delivered dose.

A special modification for the measurement of the particle size of nasal sprays according to Aaiche and Beyssac is also available as an option.

ANCILLARIES

The following ancillaries are required in addition to the GTI to complete a fully operating test system for determining the a APSD of MDIs, DPIs, nebulisers and nasal sprays:

- Mouthpiece Adapter (see Page 90)
- Vacuum Pump (see Page 91)
- Flow Meter (see Page 88)

Cat. No. Description

8901	Glass Twin Impinger
8999	Modification for Nasal Sprays (acc. to Aaiche & Beyssac)

Spare Parts

8903	Throat (Ph.Eur. Code B)
8904	Neck (Ph.Eur. Code C)
8905	Upper Impingement Chamber (Ph.Eur. Code D)
8906	Coupling Tube (Ph.Eur. Code E)
8907	Screwthread Side-Arm Adapter (Ph.Eur. Code F)
8912	Lower Jet Assembly (Ph.Eur. Code G)
8908	Lower Impingement Chamber (Ph.Eur. Code H)
8909	Throat Flow Meter Adapter (Ph.Eur. Code I)
8910	Vacuum Pump Adapter (Ph.Eur. Code J)
8913	Set of 2 Conical Joint Clips (Yellow)
8914	Set of 4 Conical Joint Clips (Green)
8916	Spare Set of Glassware (incl. clips and Lower Jet Assembly)

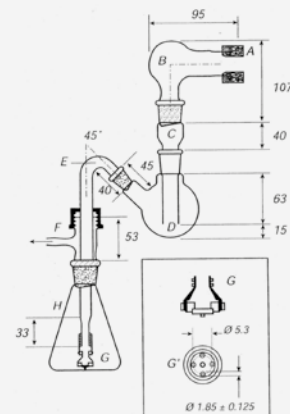

↑ Schematic of Glass Twin Impinger

Impactors for Testing MDIs with Spacers and VHCs

INTRODUCTION

Spacers and Valved Holding Chambers (VHCs) are add-on devices which are used in conjunction with Metered Dose Inhalers (MDIs) to overcome the problems of poor inhalation technique, e.g. the patient delays inhalation after actuating the inhaler.

A full description of these add-on devices and their use can be found on Pages 36 and 37.

In **Section 3**, the new USP chapter <1602> **Spacers and Valved Holding Chambers used with Inhalation Aerosols** specifies two tests relating to the Aerodynamic Particle Size Distribution (APSD) of the add-on devices used with the MDI.

In both cases, the spacer/VHC is tested with the facemask removed.

Test 3.1 is designed to measure the APSD from the spacer/VHC when used in optimal conditions, that is to say, with no delay following actuation of the inhaler.

Direct comparisons can then be made between the APSD produced by the MDI both with and without the add-on device.

If the spacer/VHC is intended for adults, then the standard ACI or NGI (without pre-separators) should be used in conjunction with a suitable pump capable of producing 28.3 or 30 L/min respectively and appropriate mouthpiece adapter.

If the add-on is intended for neonates, infants or small children, then use the NGI at a flow rate of 15 L/min.

Test 3.2 is used for testing VHCs only and is designed to measure the APSD from the VHC when used in “worst case” conditions, that is to say, with **a delay of 2 or more seconds** between inhaler actuation and sampling onset.



The delay can be simulated by placing a timer controlled two way solenoid valve such as the Breath Actuation Controller Model BAC 2100 between the impactor and the pump (see illustrations).

A **MDI Actuation Sensor** mounted on the MDI and linked to the BAC 2100 activates the timing mechanism immediately the MDI is actuated, removing any need for the complex shutter plate mechanism described in the chapter.

The BAC 2100 provides near instantaneous starting and stopping of the air flow during testing and has both delay and inhaled time functions without compromising the integrity of the induction port and/or test setup.

In the case of those add-on devices incorporating facemasks, Section 3 of Chapter <1602> specifies that the facemask

should first be removed and the spacer/VHC connected to the induction port by means of a suitable connector.

In this case, all that is necessary is to use the apparatus described in the preceding pages.

The reason for the removal of the facemask in the chapter is not clearly stated. However, it seems likely that this is a problem of standardisation coupled with commercial availability, since the inlet orifice of a spacer/VHC can be irregularly shaped or larger than the inlet of the induction port to which it is to be coupled.

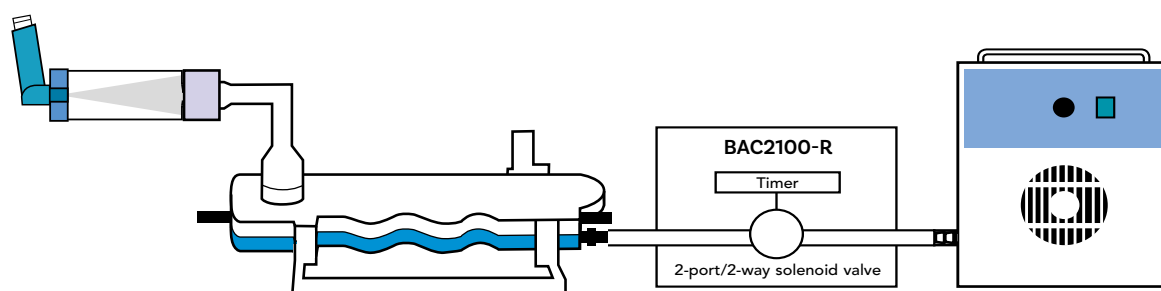

↑ NGI-based System (with Pump and Breath Actuation Controller Model BAC 2100-R)

Impactors for Testing MDIs with Spacers and VHCs

Indeed, the importance of facemask performance and the difficulties associated with it are alluded to in Section 1.4 Recommendations of the same chapter.

DESCRIPTION

The **Facemask Test Apparatus (FMA) to Next Generation Impactor (NGI) Interface Accessory** overcomes these difficulties and makes it easy to measure the APSD of MDIs with spacers/VHCs that utilise facemasks, using the NGI, in a more realistic, relevant and reproducible manner.

The unit provides a direct connection between the facemask and the NGI Induction Port and hence allows child or adult facemasks to be interfaced directly with the NGI under controlled conditions.

The alternative approach of removing the facemask often leads to a poor fit between the spacer/VHC orifice and the induction port, making the test method less representative of the clinical situation.

ANCILLARIES

The following ancillaries are required to complete a fully operating test system for determining the APSD of spacers/VHCs attached:

- Cascade Impactor (see Page 45 for ACI Page 50 for NGI)
- Induction Port (see Pages 49/53)

- Breath Actuation Controller and MDI Actuation Sensor (see Page 86)
- Vacuum Pump (see Page 91)
- Flow Meter (see Page 88)

Additionally with mouthpieces:

- Mouthpiece Adapter (see Page 90)

Additionally with facemasks:

- Facemask Test Apparatus for Spacers & VHCs Model FMA (see Page 38) - NGI Only

Cat. No. Description

Facemask based products

- | | |
|------|--|
| 9154 | Adult/Child Head to NGI Induction Port Adapter |
| 9155 | FMA/FMS to NGI Interface Accessory |
| 9157 | Flow Meter Adapter for Adult/Child Head |



← Facemask Testing Apparatus (FMA) to NGI Interface Accessory showing Child Head connection to Induction Port

↓ Facemask Testing Accessory (FMA) to NGI Interface Accessory

Impactors for Testing Nasal Delivery Systems



← NGI with 5000 mL Expansion Chamber

ACI with 2000 mL Expansion Chamber →

INTRODUCTION

Traditionally, nasal preparations have been used for the local administration of anti-histamines, decongestants, and steroids in order to alleviate cold or allergy symptoms and nasal congestion. More recently, attention has focused on two other areas:

- a) The potential rapid drug absorption into the systemic circulation provided by the turbinates and lymphoid tissues located at the back of the nasal cavity. This is already in use in a number of areas, e.g. migraine and pain relief, osteoporosis, vaccines
- b) The potential of the “Nose to Brain” entry to the central nervous system presented by the olfactory region at the top of the nasal cavity for the treatment, for example, of diseases of ageing such as Alzheimer’s Disease

Conventional nasal technologies fall into three main categories (see Page 11):

- Metered Spray Pumps (Aqueous)
- Propellant-based Nasal Aerosols (MDIs)
- Powder-based Nasal Devices

Nasal sprays typically produce droplets in the range 20-200 microns, which is outside the effective range of inertial impactors. For this reason, the droplet size distribution of nasal sprays and aerosols is normally determined by means of laser diffraction.

At the same time however, most sprays deliver a proportion (typically <5%) of fine droplets in the <10 micron range.

It is important to quantify this **Fine Particle Dose (FPD)** since it can penetrate beyond the nasal tract and into the lower respiratory tract or lungs, which may be undesirable.

In its Draft Guidance “Bioavailability and Bioequivalence Studies for Nasal Aerosols and Nasal Sprays for Local Action” of April 2003, the FDA recognises the nature of this problem and recommends the use of a cascade impactor in conjunction with a high volume expansion chamber to measure the amount of drug in small particles or droplets in respect of nasal sprays and the particle/droplet size distribution in the case of nasal aerosols.

The purpose of this exercise is to quantify the amount of drug present in the form of particles or droplets that are less than 10 microns, with a view to predicting their possible deposition in the lungs.

DESCRIPTION

In accordance with the draft guidance, Copley now offers a range of glass expansion chambers to meet these requirements.

In the case of **nasal sprays**, a 2 litre or larger (5 litre) expansion chamber is preferred. In the case of **nasal aerosols**, a 1 litre chamber is used to maximise drug deposition below the top stage of the impactor.

Each of the chambers contains an entry port at approx. 30 degrees to the outlet port for insertion of the nasal spray or aerosol.

Special nosepiece adapters are available for the entry port to accommodate powder, spray and aerosol based devices.

Adapters are also available to connect the outlet port of the expansion chamber to the inlet cone of the Andersen Cascade Impactor (ACI).

The adapters are available in aluminium, 316 stainless steel or titanium and have internal dimensions similar to those at the outlet of the USP Induction Port typically used for orally inhaled products (OIPs).

Each adapter is supplied with a clamping device which allows the glass expansion chamber to be easily removed from the impactor for assay.

Impactors for Testing Nasal Delivery Systems



↑ Reduced Stack ACI

During use, the clamp provides an airtight seal between the expansion chamber and the adapter through the use of an FDA approved silicone rubber O-ring incorporated into the neck of the adapter.

A special adapter and clamp are also available for the Next Generation Impactor (NGI).

The majority of nasal products are designed to generate droplets/particles having a mass median aerodynamic diameter (MMAD) of greater than 10 to 20 microns. This is to increase nasal deposition and minimise deposition in the lungs.

Cascade Impactors, on the other hand, are designed to capture particles in the range 0 to 10 microns. It follows that the majority of particles discharged from a nasal product will be deposited on the upper stages of the impactor.

As a general rule, the potential areas of interest may be divided into three groups:

1. Those particles >10 microns and hence retained in the intranasal passageways
2. Those particles between 5 and 10 microns destined for the upper respiratory tract
3. Those particles <5 microns potentially capable of depositing in the deep lungs

3. Those particles <5 microns potentially capable of depositing in the deep lungs

After validation, it may therefore be appropriate to use a reduced impactor stack (e.g. Stage 0 = >9 microns, Stage 2 = 4.7 to 9 microns, Stage F = 0.0 - 4.7 microns of an ACI at 28.3 L/min).

In these cases, the "Quick Clamp" (see Page 49) can be used, which is designed to clamp the ACI with a reduced number of stages, or the special version of the ACI (the FSA) classified under AIM (see Page 62).

ANCILLARIES

The following ancillaries are required in addition to the items below to complete a fully operating test system for determining the FPD of nasal sprays and aerosols:

- Cascade Impactor (see Page 45 for ACI, Page 50 for NGI)
- Vacuum Pump (see Page 91)
- Flow Meter (see Page 88)

Cat. No. Description

Expansion Chambers

8950	1000 mL Glass Expansion Chamber
8951	2000 mL Glass Expansion Chamber
8952	5000 mL Glass Expansion Chamber
8953	Volume Verification Certificate for Expansion Chamber
8954	Adapter & Clamp for ACI/FSA*
5217	Adapter & Clamp for NGI/FSI*
8961	Set of 10 O-Rings for Expansion Chamber Adapter
5212	'Quick Clamp' for ACI
8955	Benchtop Holder for Glass Expansion Chamber

Nasal Adapters

8957	Nasal Aerosol Nosepiece Adapter for Expansion Chamber Inlet
8958	Tooling Charge (per nasal aerosol device)
8959	Nasal Spray Nosepiece Adapter for Expansion Chamber Inlet
8960	Tooling Charge (per nasal spray device)
8956	Expansion Chamber to Flow Meter Adapter

* Please specify **Aluminium (A)**, **316 Stainless Steel (S)** or **Titanium (T)** when placing your order.



↓ Expansion Chamber to Flow Meter Adapter

↑ Benchtop Holder for Glass Expansion Chamber

Impactors for Testing Nebulisers



↑ The NGI Cooler fitted with two entry ports to facilitate use with the Mixing Inlet, if required (see page 72)

INTRODUCTION

In 2006, the European Medicines Agency (EMA) issued a new “Guideline on the Pharmaceutical Quality of Inhalation and Nasal Products” in which they included regulatory guidance on the drug aspects of nebulisers on the grounds that the safety and efficacy of nebulisers are dependent on the nebuliser/drug combination and not just on the nebuliser alone.

As a result of the EMA initiative and recognising the lack of suitable test methods for nebulisers, the Pharmacopoeias have in turn introduced a chapter on “**Preparations for Nebulisation: Characterisation**” (see Ph.Eur. Chapter 2.9.44 and USP Chapter <1601>).

It is these proposals that form the basis for the tests specified in Annex C of the **ISO 27427:2013** requirements (based on the European Standard EN 13544-1:2007) for the “safety, performance and testing for general purpose nebulising systems intended for continuous or breath-actuated delivery of liquids in an aerosol form, to humans through the respiratory system”, and the tests and equipment outlined here.

The recommended **flow rate of 15 L/min** employed in the APSD testing of nebulisers is lower than that of other OINDPs in order

to better simulate the normal tidal breathing conditions employed in their *in vivo* use.

For this reason, an EPAG (European Pharmaceutical Aerosol Group) led initiative was launched in 2002 to provide an extension to the archival calibration of the Next Generation Impactor (NGI) to 15 L/min.

The results published in 2004 indicated that the NGI could be used to meet the requirements of the future standard, albeit without the preseparator and by using the internal filter holder to collect any fine droplets less than 0.98 microns. Cup coating is not normally required.

This produces an impactor with seven stages having cut-off diameters at 14.1, 8.61, 5.39, 3.30, 2.08, 1.36 and 0.98 microns respectively at 15 L/min.

NGI COOLER

It is understood that for devices such as nebulisers, which deliver the active as an aerosolised solution, evaporation exacerbated by the thermal mass of the impactor can be a problem.

The ensuing loss of solvent reduces droplet size, producing artificially low particle size measurements and thus compromising the integrity of the resulting data. Cooling the impactor to approximately 5 degrees Celsius is the recommended method for overcoming this problem.

The **NGI Cooler** accommodates the NGI, either closed or open, allowing testing in a temperature controlled environment. User adjustable to 5 degrees C, temperature stability is to within +/- 1.5 degrees C. Large front and rear opening doors allow for easy access with special access ports to accommodate the nebuliser, mixing inlet (if used) and vacuum pump tubing. Additional space allows for cooling of additional sets of collection cups, so multiple tests can be undertaken in quick succession.

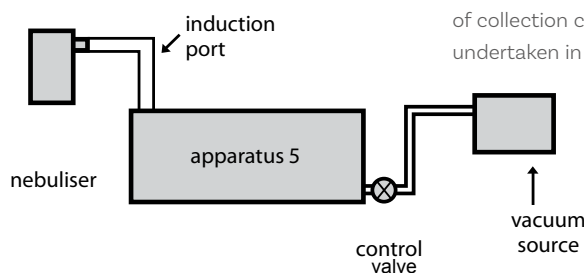

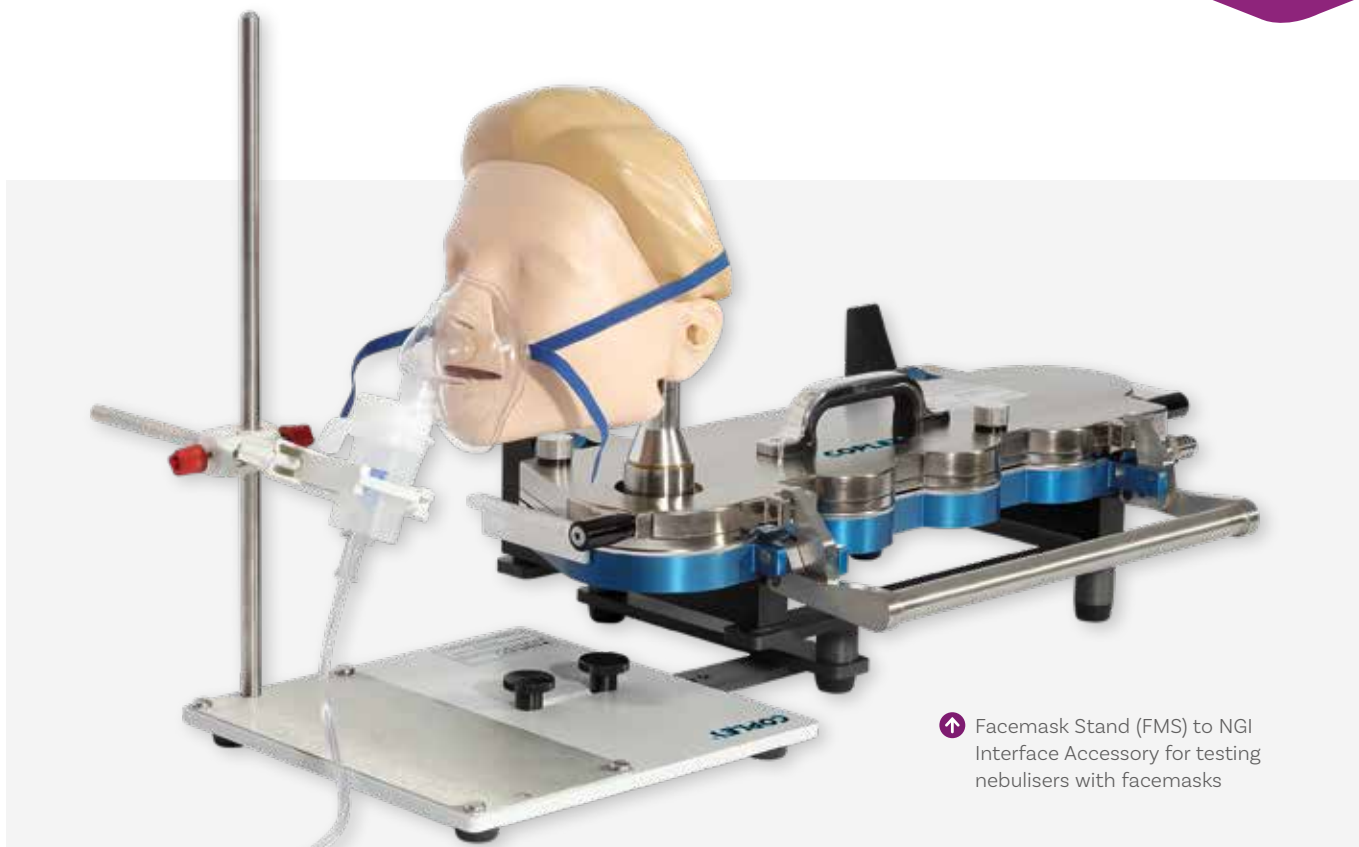

↑ Facemask Stand (FMS) to NGI Interface Accessory for testing nebulisers with facemasks

PROCEDURE

Determine the sampling time (T^0) by balancing stage overload against analytical sensitivity. The time chosen should be sufficient to ensure adequate sample is collected for analysis without overloading the collection cups concerned.

Using a suitable flow meter, set the flow rate to 15 L/min then proceed as follows:

1. Prepare the nebuliser for operation in the normal manner
2. Switch on the vacuum pump and the NGI Cooler (if required) and allow to stabilise
3. Ensure that the environmental conditions are as required
4. Switch on the nebuliser

5. Sample for the predetermined time (T^0)
6. Switch off the nebuliser and vacuum pump
7. Dismantle the impactor and, using a suitable method, determine the mass of active drug collected in the induction port, on each stage and on the final filter
8. Collect and present the data as described in the monograph

ANCILLARIES

The following ancillaries are required in addition to the items below to complete a fully operating test system for determining the APSD of nebulisers:

- Mouthpiece Adapter (see Page 90)
- NGI (see Page 50)

- Induction Port (Page 53)
- Internal Filter Holder (see Page 53)
- Vacuum Pump (see Page 91)
- Flow Meter (see Page 88)
- Data Analysis Software (see Page 94)

Additionally with mouthpieces:

- Mouthpiece Adapter (see Page 90)

Additionally with facemasks:

- Facemask Stand for Nebulisers (Page 34)

Note: The NGI Cooler can only be used for nebulisers with mouthpieces. For nebulisers with facemasks the NGI will need to be removed from the NGI Cooler for testing, once the required temperature has been reached.

Cat. No. Description

Facemask-based products

9154	Adult/Child Head to NGI Induction Port Adapter
9155	FMA/FMS to NGI Interface Accessory
9157	Flow Meter Adapter for Adult/Child Head

NGI Cooler

5009	NGI Cooler
5011	NGI Cooler Qualification Documentation
5012	NGI Cooler Qualification Tools
5013	Re-calibration of NGI Cooler Qualification Tools



↑ Internal Filter Holder

Abbreviated Impactor Measurement (AIM)

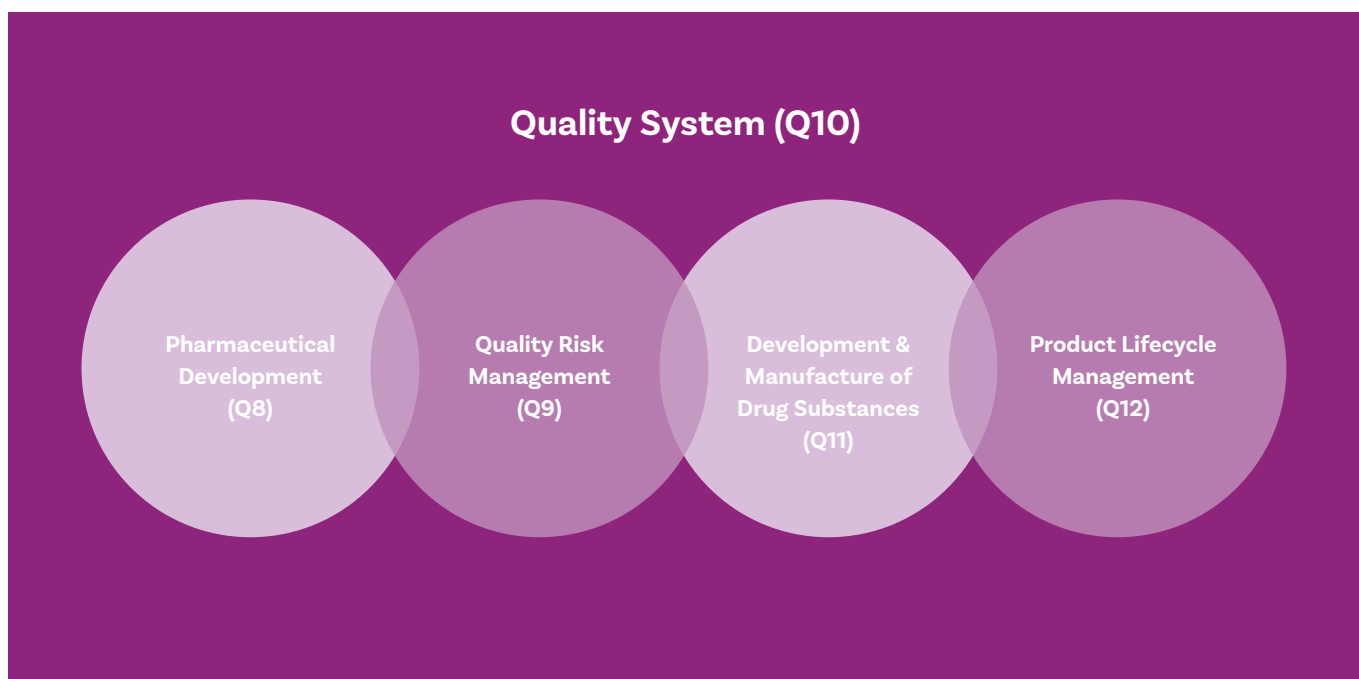

INTRODUCTION

In 2002, the FDA launched a new initiative “Pharmaceutical cGMPs for the 21st Century” in which it proposed a new approach to pharmaceutical manufacturing. This initiative gave birth to **Process Analytical Technology (PAT)**, a framework for understanding and improving the processes involved in pharmaceutical development, manufacturing and quality assurance described in the FDA’s Guidance of September 2004.

The goal of PAT is to ensure final product quality by supporting enhanced understanding and control of the manufacturing process used for pharmaceutical products. It is therefore entirely consistent with QbD, the premise that quality should not be tested into a product but rather built or designed in, from the outset.

The **Quality by Design (QbD)** approach agreed and recommended for adoption by the EMA, FDA and the Japanese MWHL in the form of the five quality related guidelines, ICH Q8, Q9, Q10, Q11 and Q12 published by the International Conference on Harmonisation (ICH), extends this philosophy to all parts of the product cycle from product development, transfer through to manufacturing, manufacturing and finally product end.

Unfortunately, because of their unique nature of part device/part formulation, the practical implementation of QbD principles to orally inhaled products (OIPs) is not easy.

Aerodynamic Particle Size Distribution (APSD) is widely recognised as a Critical Quality Attribute (CQA) in the *in vitro* characterisation of an OINDP. This is because it is the APSD of an aerosol cloud that influences where the particles in that cloud are deposited in the respiratory tract following inhalation and hence is a major determinant in its therapeutic efficacy.

The preferred instrument of choice for measuring the APSD of inhaled products for both regulators and pharmacopoeias alike is the cascade impactor. This is because it has three unique features which currently no other technique can replicate:

1. Cascade impactors measure **aerodynamic** particle size
2. Cascade impactors measure the **active pharmaceutical ingredient**
3. Cascade impactors measure the **entire dose**

However, while cascade impaction provides the measure of particle size that is most relevant to deposition in the human respiratory tract, the physical characteristics

of the human respiratory tract means that cascade impaction can never directly simulate the lungs.

Further, whilst providing a detailed size classification of the aerosol cloud concerned, recent QbD initiatives have drawn attention to the fact that the full resolution multi-stage cascade impaction methods commonly used to determine the APSD of OIPs can not only be laborious and time consuming but also require a high degree of skill and consistency on the part of the analyst if error is to be avoided.

The analytical and instrumental factors underlying these errors have been systematically reviewed by the Product Quality Research Institute (PQRI) in an article entitled “Considerations for the Development and Practice of Cascade Impaction Testing including a Mass Balance Failure Investigation Tree”, *J.Aerosol.Med.*, 2003; 16(3): 235-247.

For these reasons, and with the adoption of QbD potentially increasing demands for analytical data, attention has once again turned to the concept of **Abbreviated Impactor Measurement**.

Abbreviated Impactor Measurement (AIM)

AIM IN THE QC ENVIRONMENT

The concept of **Abbreviated Impactor Measurement (AIM)**, as typified by the Glass Impinger on Page 55 (still available as Apparatus A in Ph.Eur.) and the Fisons Single Stage Metal Impactor described in earlier versions of the Ph. Eur. (until 2002) is not new. However, the initiative in recent years started with abbreviated versions of the Andersen Cascade Impactor (ACI).

The concept is founded on the basis that once the full Aerodynamic Particle Size Distribution (APSD) profile of the product has been established in development using a full-resolution cascade impactor (and the process validated) then for product batch release testing and QC applications, it is possible to use simpler but highly sensitive metrics, solely to determine if the product is fit for purpose. This is known as **Efficient Data Analysis (EDA)**.

Typically the APSDs of inhaled products are in the form of a Normal (or Gaussian) Distribution centred around the Mass Median Aerodynamic Diameter (MMAD). It is therefore possible to determine even subtle changes in the APSD by measuring the following:

1. Impactor Sized Mass (ISM) which is considered the sum of the drug mass deposited on the filter and all impactor stages except the uppermost. This metric indicates any shift in the amplitude of the APSD.

2. Ratio of Large Particle Mass to Small Particle Mass (LPM/SPM)

which is considered to be the ISM split into two fractions on either side of the MMAD: LPM greater than the MMAD and SPM smaller than the MMAD. This ratio indicates any shift in the central tendency of the APSD.

Although EDA can be applied to full-resolution impactor testing, its true value comes from combining it with AIM, since only a reduced number of impactor stages are required, speeding up throughput and further reducing analytical error. Full-resolution impactor testing is then reserved for out-of-specification (OOS) investigations.

In the diagram below, the **AIM-QC model** shows how abbreviating the ACI to just 2 stages and a filter, with the central stage (Stage X) selected to have a cut-off diameter close to the product MMAD, allows the EDA metrics of ISM and LPM/SPM to be easily determined.

The table on Page 46 indicates which ACI stage can be used for "Stage X" depending on the test flow rate and product MMAD (as determined from full-resolution impactor testing).

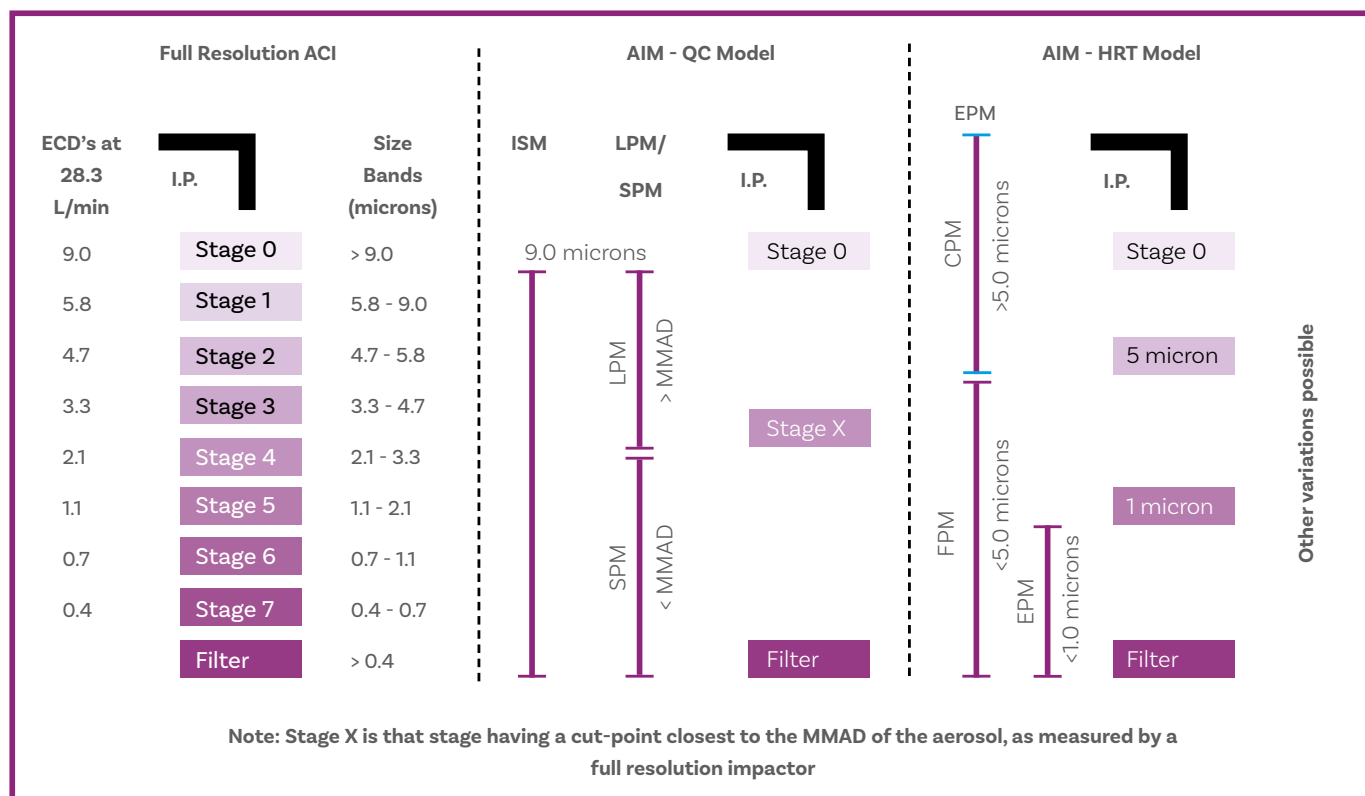

Adapted from: Mitchell, J.P. et al. Relative Precision of Inhaler Aerodynamic Particle Size Distribution (APSD) Metrics by Full Resolution and Abbreviated Andersen Cascade Impactors (ACIs): Part 1., AAPS PharmSciTechnol., 2010, 11(2): 843-851

Abbreviated Impactor Measurement (AIM)

AIM IN THE R&D ENVIRONMENT

Abbreviated Impactor Measurement (AIM) has also been suggested as a useful tool in R&D for the fast screening of new formulations in product development.

Abbreviated impactors have three main advantages over their more conventional multi-stage counterparts:

- a) Speed of throughput (this allows more samples to be measured in a given time frame)
- b) Less complicated so less prone to method and analyst error and
- c) Far easier to automate

As far as R&D is concerned, the main aim is to find a link between *in vitro* and *in vivo* performance so as to reduce the dependence on time-consuming and expensive clinical trials.

This is not easy; as has been mentioned before, a cascade impactor is not analogous to the lung. The lung is a complex organ, with high humidity, decreasing velocity with each bifurcation and complex deposition mechanisms (diffusion and sedimentation, as well as impaction). This makes correlation between *in vitro* cascade impactor measurements and deposition in the **Human Respiratory Tract (HRT)** highly complex.

Nevertheless, there is some evidence to suggest that abbreviated versions of full stack cascade impactors can be used to broadly indicate *in vivo* lung deposition based on two or three size bands (or fractions):

- 1. Coarse Particle Mass (CPM)** – That portion of the aerosol considered to be too large to be inhaled (usually considered to be >5 microns)
- 2. Fine Particle Mass (FPM)** – That portion between 5 and 1 micron, usually considered likely to deposit deep into the lung and hence be therapeutically effective
- 3. Extra-fine Particle Mass (EPM)** – That portion below 1 micron, usually considered to be too small to deposit in the lung and potentially exhaled

In this case, the **AIM-HRT model** shown in the diagram on Page 63 shows how abbreviating the ACI to 2 stages, plus a filter and a spacer can be used to determine the CPM, FPM and EPM.

The selected stages have **cut-off diameters** equal or close to 5 and 1 microns. The spacer provides additional dead space prior to the first impaction stage, equivalent to a full resolution impactor. This has been shown to be significant for improving the equivalence between AIM and full-resolution measurements for ethanol based MDIs.

Other stages can be used if their cut-off diameters are considered more applicable to the HRT correlation that is trying to be achieved.

AIM - THE FUTURE

In order to meet these various demands and to provide a basis for the proof-of-concept work necessary to validate them, Copley has introduced a number of different versions of abbreviated impactor for use in both **QC (QC Models)** and **R&D (HRT Models) environments** based on reduced stage versions of the popular Andersen Cascade Impactor (ACI) and Next Generation Impactor (NGI). Full details may be found on Pages 65 to 67.

If validated and implemented, such impactors could effectively help to speed up the process of screening formulations in the early development phases, prior to full-resolution impactor studies being performed on the most promising candidates.



← FSA-HRT with Adult Alberta Idealised Throat

Abbreviated Impactor Measurement (AIM)

FAST SCREENING ANDERSEN (FSA)

The Fast Screening Andersen (FSA) is an AIM version of the standard Andersen Cascade Impactor (ACI) suitably modified to provide a reduced stack plus filter (F) suitable for either:

- Quality Control (**FSA-QC**) or
- Product Development (**FSA-HRT**)

The principles of each type are described on Pages 63 and 64.

In the **FSA-QC**, Stages 0 (or -1, or -2A) and F are used in conjunction with a **Stage X**, having a cut-off diameter as close as possible to the **Mass Median Aerodynamic Diameter (MMAD)** of the aerosol, as

determined during full resolution cascade impactor testing.

In the **FSA-HRT** stages with cut-off diameters are available at **5.0 and 1.0 microns** for MDI applications at 28.3 L/min. Also, for this flow rate and higher flow rates (60 and 90 L/min) stages having traditional ACI cut-points of **4.7 and 1.1 microns** are available, primarily for DPI applications.

ANCILLARIES

The following ancillaries are required in addition to the FSA to complete a fully operating test system for determining the CPM, FPM, EPM or LPM/SPM ratio of MDIs:

- Mouthpiece Adapter (see Page 90)
- Induction Port (see Page 65)
- Vacuum Pump (see Page 91)
- Flow Meter (see Page 88)

Additionally to test DPIs:

- Preseparator (see Page 65)
- Critical Flow Controller (see Page 80)



↑ FSA-QC (in 316 Stainless Steel)

Cat. No. Description

FSA-QC with Stage X cut-off diameter close to product MMAD

8341	FSA-QC - 28.3 L/min (Stages 0, X and F)*
8342	FSA-QC - 60.0 L/min (Stages -1, X and F)*
8343	FSA-QC - 90.0 L/min (Stages -2A, X and F)*

FSA-HRT with cut-off diameters of 5.0 and 1.0 or 4.7 and 1.1 microns

8344	FSA-HRT - 28.3 L/min (Spacer, Stages 5.0 and 1.0 micron, and F)*
8345	FSA-HRT - 28.3 L/min (Spacer, Stages 2, 5 and F)*
8346	FSA-HRT - 60.0 L/min (Spacer, Stages 1, 4 and F)*
8347	FSA-HRT - 90.0 L/min (Spacer, Stages -0, 3 and F)*

Induction Ports

8501	USP Induction Port*
8510	USP Induction Port (One-piece 316 Stainless Steel)
8060	Flow Meter to Induction Port/WSC2 Adapter

Preseparators for testing DPIs

8401	28.3 L/min Preseparator*
8420	60 L/min Preseparator*
8420-90	90 L/min Preseparator*

Spare Parts

8367-I	Stage 5.0 micron cut-off @ 28.3 L/min*
8368	Stage 1.0 micron cut-off @ 28.3 L/min*
8371	FSA Spacer Stage*
8334	Complete Set of 7 Silicone Rubber O-Rings
8335	Set of 2 Stainless Steel Collection Plates (28.3 L/min)
8336	Set of 2 Stainless Steel Collection Plates (60 or 90 L/min)
8316	Box of 100 Glass Fibre Filters
8308A	Set of 3 Shortened Spring Clamps - 4 Stage
8308B	Set of 3 Shortened Spring Clamps - 3 Stage

*Please specify **Aluminium (A)**, **316 Stainless Steel (S)** or **Titanium (T)** when placing your order.

Abbreviated Impactor Measurement (AIM)

Stage Cut-off Diameters for the Next Generation Impactor at Different Flow Rates									
Stage	Flow Rate (L/min)								
	15	30	40	50	60	70	80	90	100
1	14.10	11.72	10.03	8.89	8.06	7.42	6.90	6.48	6.12
2	8.61	6.40	5.51	4.90	4.46	4.12	3.84	3.61	3.42
3	5.39	3.99	3.45	3.09	2.82	2.61	2.44	2.30	2.18
4	3.30	2.30	2.01	1.81	1.66	1.54	1.45	1.37	1.31
5	2.08	1.36	1.17	1.04	0.94	0.87	0.81	0.76	0.72
6	1.36	0.83	0.70	0.61	0.55	0.50	0.46	0.43	0.40
7	0.98	0.54	0.45	0.38	0.34	0.31	0.28	0.26	0.24

Determined from: Virgil A. Marple et al. Next Generation Impactor (A New Impactor for Pharmaceutical Inhaler Testing). Part II: Archival Calibration: Journal of Aerosol Medicine; Volume 16, Number 3, 2003; 301-324 and Part III: Extension of Archival Calibration to 15 L/min: Journal of Aerosol Medicine; Volume 17, Number 4, 2004; 335-343

REDUCED NGI (rNGI)

As described on the previous pages, the drive for greater efficiency is stimulating debate as to whether full-resolution, multiple-stage cascade impaction still needs to be applied to the extent that it is currently.

The **Reduced Next Generation Impactor (rNGI)** is an abbreviated method for utilising the NGI for both AIM-QC or AIM-HRT applications. In the case of the NGI, the individual stages are fixed within the seal body, such that they cannot be removed. In order to use the NGI in an abbreviated form, it is possible to use the Exhaust Cup to bypass certain stages (see Page 52). Alternatively the **rNGI Filter Holder Assembly** can be used.

In the same way as with the FSA, depending on the flow rate to be used, a stage between 2 and 4 (see blue highlights in the table above) of the NGI can be selected having a cut-off diameter close to the product MMAD (in the case of an **rNGI-QC** application) or close to 5 microns (in the case of an **rNGI-HRT** application). The cut-off diameters at a range of flow rates are shown in the table above.

The rNGI Filter Holder Assembly is placed in the stage immediately after the cut-off stage selected.

The rNGI Filter Holder Assembly consists of a filter support mesh which is placed on top

of the stage nozzles and a split ring used to hold the filter in position on top of the filter support mesh.

On operating the rNGI, particles smaller than the cut-off diameter of the stage preceding the rNGI Filter Holder Assembly will be captured on the paper filter of the rNGI, whilst particles larger than the cut-off diameter of the stage preceding the rNGI Filter Holder Assembly will impact as normal in the collection cups of those stages upstream.

Note that when using the rNGI Filter Holder Assembly it is not possible to have a second stage representing the Extra-fine Particle Mass (EPM).

The flow resistance and the total volume of the NGI are not appreciably affected by the presence of the rNGI Filter Holder Assembly and therefore with careful selection of a suitable filter this approach can be useful for AIM studies of DPIs, when equivalence between NGI and rNGI data is desirable, but where start-up kinetics issues may otherwise be significant.

When the NGI is being used in the rNGI configuration, no modifications to the collection cups or method of assay are required.

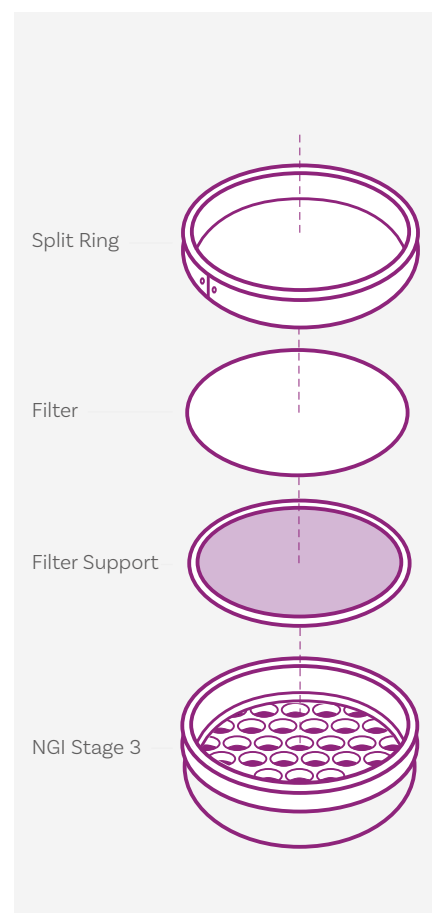

Cat. No.	Description
5259	rNGI Filter Holder Assembly
5259A	Pack of 100 Filters

Abbreviated Impactor Measurement (AIM)

FAST SCREENING IMPACTOR (FSI)

Based on proven NGI Preseparator technology, the **Fast Screening Impactor (FSI)** represents a purpose-made approach to AIM that separates the dose into Coarse Particle Mass (CPM) and Fine Particle Mass (FPM) making it suitable for **AIM-HRT** application (i.e. **FSI-HRT**) for MDIs, DPIs and nasal sprays.

A range of inserts are available, to generate a 5 micron cut-off diameter within the flow rate range of 30-100 L/min at 5 L/min intervals, making it ideal for DPIs tested at a flow rate that equates to a 4 kPa pressure drop over the inhaler.

The FSI uses the same induction port as the NGI. It employs a two-stage separation process in which first large non-inhalable boluses are captured in a liquid trap followed by a fine-cut impaction stage at 5 microns. This gives unparalleled accuracy,

high capacity, low internal losses and low carryover. The fine particle dose is collected on a glass fibre filter located in an external filter holder with quick-release catches for easy access.

A preseparator may be used, if required, to remove large non-inhalable particles, as with a conventional impactor. This also adds volume and has been shown to improve correlation with the NGI, when testing DPIs.

An additional insert is available for generating a 10 micron cut-off diameter at 30 L/min which when used with a glass expansion chamber (see Page 59) makes it ideal for the fast screening of nasal aerosols and sprays.

Bespoke inserts are also available on request with a range of cut-off diameter/flow rate combinations, allowing for an **FSI-QC** version, with a cut-off diameter selected close to the product MMAD.

ANCILLARIES

The following ancillaries are required in addition to the FSI to complete a fully operating test system for determining the CPM, FPM or LPM/SPM ratio of MDIs:

- Mouthpiece Adapter (see Page 90)
- Induction Port (see Page 67)
- Vacuum Pump (see Page 91)
- Flow Meter (see Page 88)

Additionally to test DPIs:

- Preseparator (see Page 67)
- Critical Flow Controller (see Page 80)

Additionally to test Nasal Sprays:

- Expansion Chamber (see Page 59)
- Nasal Adapter (see Page 59)



↑ Interchangeable Inserts



↑ Filter Holder

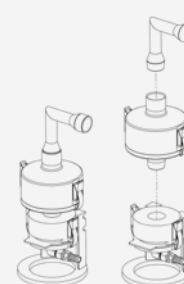

↑ FSI Schematic



↑ Fast Screening Impactor

Cat. No. Description

Fast Screening Impactor (FSI) complete

- 5260 FSI complete with one insert (please specify flow rate – see below)
- 5261 Additional Inserts – 5 microns @ 30, 35, 40, 45, 50, 55, 60, 65, 70, 75, 80, 85, 90, 95 or 100 L/min for MDIs or DPIs (please specify flow rate)

- 5240 Box of 100 Filters (for Fine Fraction Collector)

Fine Fraction Collector for users that already have NGI Preseparator

- 5262 Fine Fraction Collector only

Note: For a complete system, users must also purchase an insert (see 5261) to replace the existing insert in their preseparator

Accessories for MDIs and DPIs

- 5203 NGI Induction Port
- 8060 Flow Meter to Induction Port/WSC2 Adapter
- 5204 NGI Preseparator

Accessories for Nasal Sprays

- 5263 Additional Insert – 10 microns @ 30 L/min for Nasal Sprays

Improved *In Vitro* - *In Vivo* Correlation (IVIVC)



↓ IVIVC System for Nebulisers with Mixing Inlet, NGI, NGI Cooler, Air Flow Controller and Breathing Simulator Model BRS 2100

INTRODUCTION

Accelerating time to market and adopting better practice in the development, manufacture and quality assurance of medicines are ongoing goals for the pharmaceutical industry.

Better IVIVCs has long been an industry aim, but the current climate clearly adds impetus to the desire for progress.

Inhaled product development in particular presents some unique challenges in this respect.

The difficulty of precisely correlating drug deposition behaviour with clinical efficacy, the impact of patient-to-patient variability and the complex interaction between formulation and device, all complicate the development process.

In the case of most DPIs, for example, the actuation and operation of the device relies solely on the breathing profile of the individual using the inhaler.

A child, for example, with chronic asthma will exhibit a vastly different breathing profile from an otherwise healthy adult using the device for systemic drug delivery purposes.

One strategy for improving the significance of cascade impaction data is to modify the test set-up in order to mimic the *in vivo* drug delivery process more closely.

Two factors that have been identified as being critical to this improvement process are:

1. Replacing the existing Ph.Eur./USP Induction Port with an age-appropriate mouth/throat model having a more realistic human-like geometry.

The Ph.Eur./USP Induction Port (Throat) normally used to interface the device with the impactor has a simple, well defined geometry developed with testing standardisation in mind.

It is easy to manufacture and gives consistent performance, essential for QC testing. However, it is widely accepted that this port does not provide an accurate representation of what happens in the upper respiratory tract *in vivo* in that it consistently under-predicts the amount of active drug captured in this area.



NGI with Child Alberta Idealised Throat and MDI with Valved Holding Chamber (VHC) →

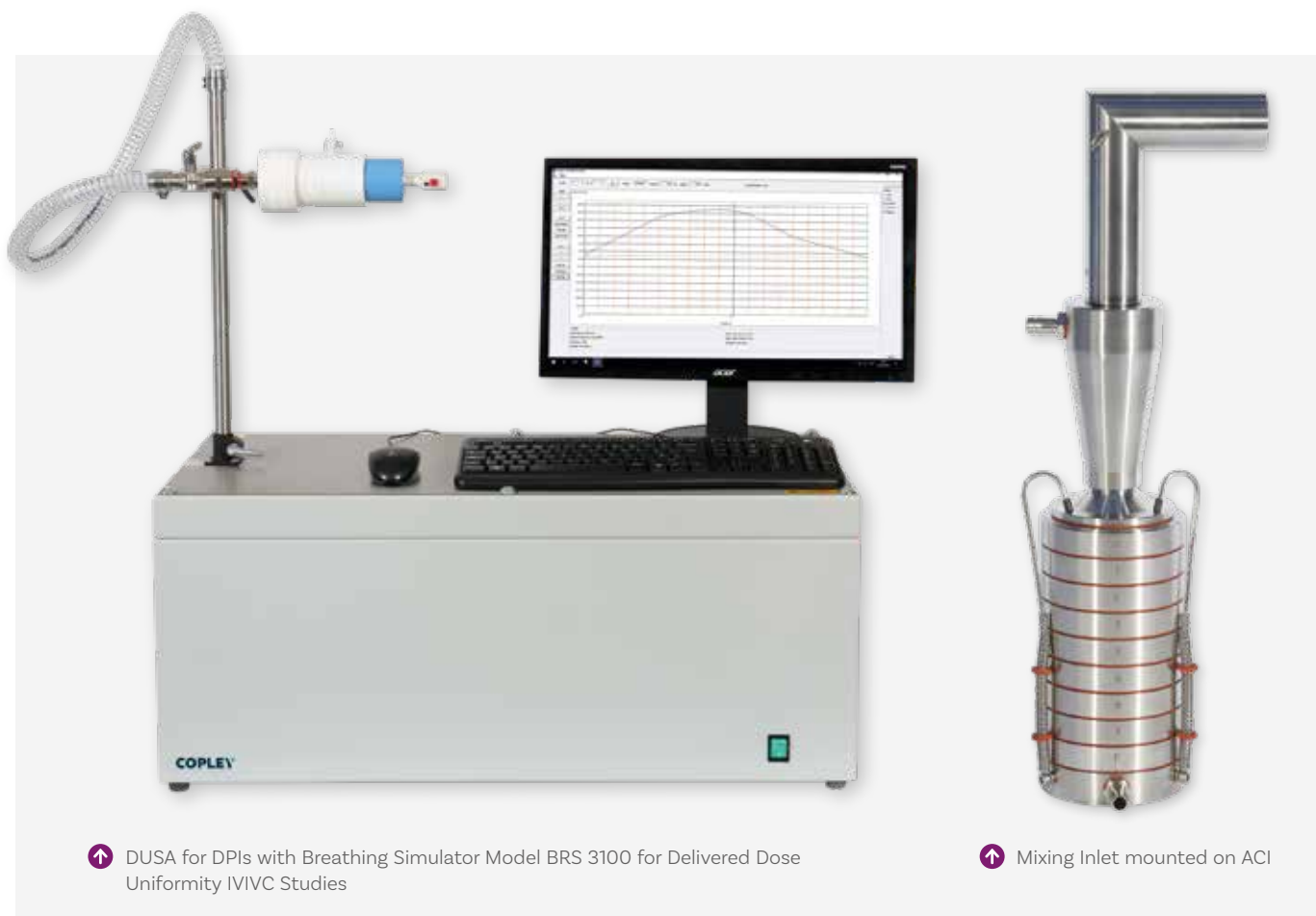

↑ DUSA for DPIs with Breathing Simulator Model BRS 3100 for Delivered Dose Uniformity IVIVC Studies

↑ Mixing Inlet mounted on ACI

Indeed, several studies have indicated that replacing the pharmacopoeial throat with one more anatomically correct in terms of oropharyngeal geometry gives more clinically accurate results.

The **Alberta Idealised Throat (AIT)** (see Page 70) is an impactor/device interface designed specifically to replace the compendial inlet and provide a more realistic representation of the human mouth/throat.

The AIT was developed as a result of extensive research into typical patient populations including visual observations combined with a review of CT scans and anatomical texts.

2. Replacing the existing constant flow rate conditions employed in testing with breathing profiles more representative of conditions *in vivo*.

Human beings do not breathe at a constant flow rate. It makes sense therefore that if more realistic test conditions are to be attained, then flow rates that more representatively simulate breathing conditions of those found *in vivo* should be applied.

For MDIs with spacers/VHCs and nebulisers, tidal breathing (at rest) is the normal mode of respiration. In the case of MDIs and DPIs, these usually require a single, forced inhalation manoeuvre designed to draw the dose deep into the lungs.

Various breathing patterns should be employed covering the age and condition of the patients to be treated (paediatric to geriatric, mild to severe impairment to the lungs).

In practice, this means replacing the fixed flow rate vacuum pump normally employed for regulatory testing with a **Breathing Simulator** (see Page 75) capable of providing breath profiles.

This in itself can lead to other problems during subsequent analysis. Applying more representative breathing profiles during testing is complicated by the fact that the impactors used to measure APSD operate at constant flow rates.

This problem can be resolved by interposing a Mixing Inlet between the induction port/throat and the cascade impactor.

The **Mixing Inlet** (see Page 72) decouples the flow rate through the device from the air flow drawn through the impactor, thereby enabling more representative testing.

Utilising geometry that encourages gentle mixing, it allows the introduction of a secondary air stream that creates a sheath flow to supplement the flow through the device, thereby entraining the sample aerosol before entry into the impactor.

This makes it possible to use a breathing simulator in conjunction with a compressed air supply and the mixing inlet to provide a breathing pattern to the device, to simulate tidal breathing or just inhalation (for DPIs), whilst simultaneously measuring the APSD in the conventional manner at a constant flow rate.

It also makes it possible, for example, to operate the product under test at a very low flow rate whilst maintaining a higher, calibrated flow rate through the impactor.

Improved *In Vitro* - *In Vivo* Correlation (IVIVC)



ALBERTA IDEALISED THROAT (AIT)

One way to accurately simulate the deposition of orally inhaled drug products (OIDPs) in the throat is to use an anatomically correct human throat cast.

The major drawback is that the geometry represented by such a cast is that of a single human subject.

Experimental work has shown significant differences in deposition behaviour between various throat casts, attributable to inter-subject variability in the geometry of the mouth and throat.

Arguably, the **USP Induction Port** routinely used in testing represents the opposite approach in inlet design to that of the cast.

Developed with testing standardisation in mind, it has a simple well defined geometry that lends itself to high precision manufacture and the consistent performance demanded in product QC testing.

Unfortunately, these benefits come at the cost of *in vivo* correlation. Indeed, whilst the induction port is ideal for QC applications, in practice, it has been found to significantly underestimate the actual amount of active drug found in the throat *in vivo*.

One method of improving *in vitro* - *in vivo* correlation is to replace the standard induction port (throat) normally used for the testing of inhalers with a throat having more human-like characteristics.

For more than a decade, researchers at the Aerosol Research Laboratory at the University of Alberta, Canada, worked to develop a more suitable representation of the mouth-throat for cascade impactor testing.

The aim was to produce an interface that is both easy to manufacture and reflective of *in vivo* behaviour, a solution with the benefits of both a human throat cast and the pharmacopoeial induction port.

The **Alberta Idealised Throat (AIT)** was developed as a result of extensive research into typical patient populations including information provided by CT and MRI scans, direct visual observation of living subjects and data in the archival literature. The throat has a standardised, highly reproducible, human like geometry offering robust performance independent of flow rate.

Its smooth, more uniform internal geometry has been specifically designed to make drug recovery quick and simple in comparison with a human throat cast. Quick release clips make for easy internal coating and drug recovery.

Two versions are available corresponding to adult and child (6-14 years old range) geometries respectively.





↑ IVIVC System for DPIs with Adult Alberta Idealised Throat, Mixing Inlet, Air Flow Controller, NGI and Breathing Simulator Model BRS 3100

OPTIMISATION

The test set-up shown above illustrates how new equipment for *in vitro* testing is being exploited to optimise data gathering for demonstrating bioequivalence in a DPI.

There are three pieces of equipment present that are routinely absent from the standard set-up: a **Breathing Simulator**; an **Alberta Idealised Throat (AIT)** (in place of the standard induction port) and a **Mixing Inlet**.

It is worth looking in detail at exactly what each element contributes.

The **Mixing Inlet** decouples the flow profile applied across the device from the flow conditions applied in the cascade impactor.

It allows the application of a patient-relevant breathing profile across the DPI while at the same time enabling the cascade impactor to work at the constant flow rate required for accurate APSD measurement.

The **Breathing Simulator** enables exploration of the impact of different breathing profiles. In bioequivalence testing it therefore allows the robust demonstration of equivalent drug delivery performance across a range of conditions that represent the variability associated with a target user group.

The flexibility to fully scope variability is far greater than with the standard pharmacopoeial test set-up.

Finally, the **AIT** addresses widely recognised limitations of the standard induction port, which does not provide a particularly accurate *in vitro* realisation of aerosol transport through the upper respiratory tract. The AIT produces data that are more representative of measured *in vivo* behaviour, thereby supporting the robust demonstration of bioequivalence. Furthermore it ensures that the APSD measurement obtained via cascade impaction corresponds with the portion of the aerosol that would likely enter the lungs.



↑ Child Alberta Idealised Throat

Cat. No. Description

Adult version

8511	Adult Alberta Idealised Throat (AIT) in Aluminium
8514	Flow Meter to Adult Alberta Idealised Throat Adapter
8516	Spare Silicone Seal for Adult Alberta Idealised Throat
8518	Leak Test Inlet Cap and Outlet Adapter for Adult AIT

Child version

8530	Child Alberta Idealised Throat (AIT) in Aluminium
8531	Flow Meter to Child Alberta Idealised Throat Adapter
8532	Spare Silicone Seal for Child Alberta Idealised Throat
8533	Leak Test Inlet Cap and Outlet Adapter for Child AIT

Child and Adult versions

8512	Alberta Idealised Throat to ACI/FSA Adapter
8513	Alberta Idealised Throat to NGI/FSI Adapter

Improved *In Vitro* - *In Vivo* Correlation (IVIVC)



↑ Next Generation Impactor (NGI) fitted with Mixing Inlet, Compressed Air Flow Controller and Inlet Manifold for constant low flow rate tests, such as paediatric studies

MIXING INLET

The cut-off diameters generated by each stage of any cascade impactor are dependent on a steady, fixed flow of air passing through it.

In contrast, the *in vivo* inhalation profiles of breathing cycles generated by patients produce a continually varying flow rate far removed from the fixed, steady-state flow rates employed in *in vitro* testing.

For this reason, over the years, there have been various attempts to link cascade impactors directly to breathing simulators (see Pages 75-79) in order to reproduce the clinical condition more closely.

Any such system must be capable of varying the flow rate through the inhaler whilst ensuring that the aerosol generated is sampled at a fixed rate through the impactor.

Another problem frequently encountered is when the test flow rate applied to the inhaler is lower than the minimum calibrated flow rate of the impactor.

This is common, for example, in paediatric studies where the user wishes to simulate the flow rate typical *in vivo* of a minor, say 10 L/min, whereas the impactor requires a flow rate of 28.3 L/min in order to operate within its calibrated range.

DESCRIPTION

The **Mixing Inlet** fits between the USP Induction Port (or AIT) and the inlet of the impactor used to carry out the test.

It is designed to permit the cascade impactor to be operated at a constant flow rate (e.g. 100 L/min), whilst allowing a lower fixed or variable rate, such as a breathing pattern generated by a breath simulator, to pass through the inhaler.

Supplementary (or “make-up”) air is provided from an **Air Compressor** to the inlet port on the side of the Mixing Inlet via a **Compressed Air Flow Controller** and **Inlet Manifold**, which serve to match the steady state flow rate entering the impactor.

This balances the flow and ensures that the flow rate at the inlet to the induction port is zero prior to starting the test.

Three different manifold configurations are available dependent on the application.

Constant Flow

In certain applications, a flow rate is required at the inhaler that is lower, than the calibrated flow rate of the impactor being used.

In paediatric studies, for example, there is a demand for low flow rates of 10 L/min or less, whilst maintaining a flow rate of 30 L/min entering the impactor.

In this case the Compressed Air Inlet Manifold for Mixing Inlet should be used (see photo above, left).



← Air Compressor for Mixing Inlet

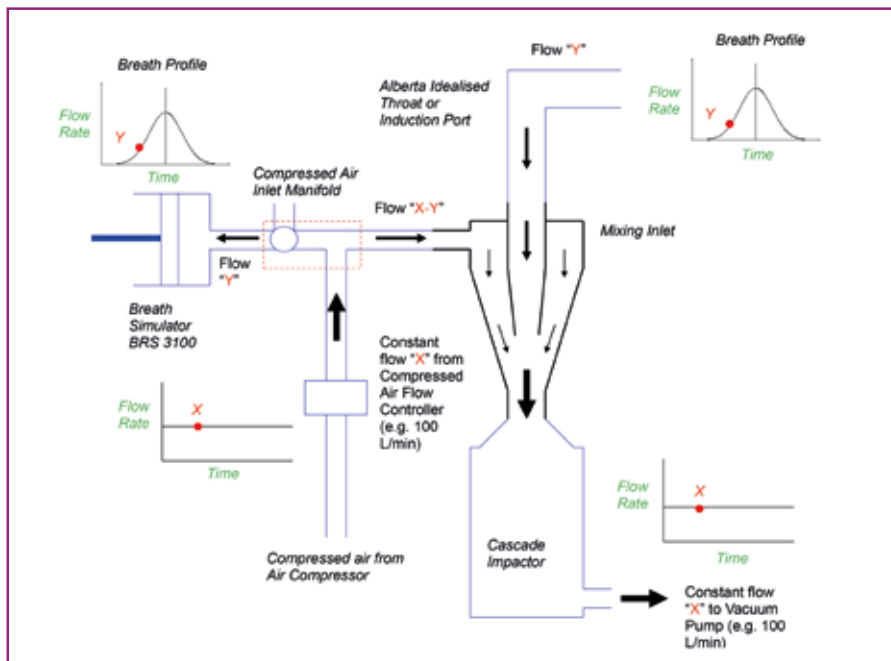

Tidal Breath Profiles

Inhaler devices such as Nebulisers and MDIs with Spacers or Valved Holding Chambers (VHCs) are designed to be operated whilst the patient is breathing normally.

To test such systems requires a breathing simulator such as the BRS 1100 or BRS 2100 linked to a suitable air inlet manifold (see schematic).

In a balanced flow condition (where the compressed air flow rate equals that entering the impactor) the breath simulator withdraws flow according to the desired breathing pattern from the compressed air line, causing the breathing pattern to be replicated at the induction port and hence the inhaler under test (see photos on Pages 76 and 78).

Inhalation-only Breath Profiles

Inhaler devices such as DPIs, MDIs and Breath-Actuated MDIs are designed to operate during a single, forced inhalation only profile. In this instance, the BRS 3100 is normally used because of its larger volume. Furthermore, the 3-way valve incorporated into the BRS 2100/3100 Air Inlet Manifold vents exhalation air to atmosphere on resetting to the start position (see photo on Page 79).

ANCILLARIES

The following ancillaries are required in addition to the Mixing Inlet to complete a fully operating test system for improving the IVVCs of APSD testing relating to MDIs, MDIs

with spacers/VHCs, DPIs and nebulisers:

- Mouthpiece Adapter (see Page 90)
- Alberta Idealised Throat (see Page 71)
- Cascade Impactor (see Page 45 for ACI, Page 50 for NGI)
- Vacuum Pump (see Page 91)
- Flow Meter (see Page 88)

Additionally to test DPIs:

- Preseparator (see Page 49 for ACI, Page 53 for NGI)

Options:

- Critical Flow Controller (see Page 80)



Cat. No.	Description
8328A	Mixing Inlet for ACI, FSA and MSLI (316 Stainless Steel)
8326	Adapter to convert 8328A for use with NGI & FSI
8327	Adapter to convert 8328A for use with NGI & FSI Induction Port
8329A	Mixing Inlet for NGI and FSI (316 Stainless Steel)
8324	Set of 2 O-Rings for ACI Mixing Inlet
9160	Compressed Air Flow Controller for Mixing Inlet
9161	Compressed Air Inlet Manifold for Mixing Inlet
9162	Compressed Air Inlet Manifold for Mixing Inlet & BRS 1100
9163	Compressed Air Inlet Manifold for Mixing Inlet & BRS 2100/3100
9164	Air Compressor for Mixing Inlet
9165	Compressed Air Flow Controller Re-Calibration Certificate
9166	Maintenance Kit for Air Compressor

Ancillaries

Introduction

This section describes the ancillaries required in addition to the Dosage Unit Sampling Apparatus (DUSA) and Cascade Impactor to make up a fully-operating test system for determining the Delivered Dose Uniformity and Aerodynamic Particle Size Distribution of Orally Inhaled and Nasal Drug Products (OINDPs).



Breathing Simulators are increasingly used in testing OINDPs to replace existing constant flow rate conditions with breathing profiles more representative of conditions *in vivo*.

Copley offer a choice of three Breathing Simulators covering the range of breathing patterns to be found in neonatal, infant, child and adult physiologies.

The **Critical Flow Controller** is designed to generate a standardised square-wave breath profile suitable for the routine testing of “passive” breath activated devices such as DPIs, where the delivered and fine particle dose of the device is dependent on the strength and duration of the patient’s inspiration.

The **Breath Actuation Controller** is an electrically operated timer controlled two-way valve specifically designed for testing MDIs according to USP chapter <601>, Breath-Actuated (or Breath Operated) MDIs and the Spacers and VHCs used with MDIs and Nebulisers to USP chapter <1602>.

Flow rate is a critical parameter in the *in vitro* testing of OINDPs. Copley offers two **Flow Meters** with the required range and accuracy to perform this task, one based on differential pressure and the other on thermal mass measurement methods. Both units will give similar readings provided they are calibrated and operated correctly.

Driving most inhaler testing systems is the **Vacuum Pump**. The Pharmacopoeias are careful to point out that “a vacuum pump with excess capacity must be selected in order to draw air, at the designated volumetric flow rate” through the system and, in the case of DPIs to generate sonic (critical) flow.

Copley offers a choice of three vacuum pumps dependent on the system set-up and the capacity required.

No inhaler testing system would be complete without the **Mouthpiece Adapters, Tubing and Quick Release Connectors** designed to link the various components of the system together.

Finally, the data analysis function, required for processing cascade impactor data, is provided by **CITDAS (Copley Inhaler Data Analysis Software)**, a proven third generation software program designed specifically for the simple and rapid processing of impactor drug deposition data according to pharmacopoeial requirements.

Developed based on over 18 years of experience, today CITDAS has over 700 users and can be installed and up and running in minutes - it requires no specialist IT knowledge to install and 21 CFR 11 does not apply because the data output is in hard copy format. It will accept data from the ACI, NGI, MSLI and/or Marple-Miller Impactor (MMI). There is provision to customise the data options to individual needs.

Breathing Simulators

Breathing Simulators →
Models BRS 2100 (left)
and BRS 3100 (far left)



INTRODUCTION

Breathing simulators, instruments that generate an inhalation and/or exhalation profile that mimics that of a human subject, have become a routine feature of orally inhaled product (OIP) testing. Their use is two fold:

1. Pharmacopoeial

To measure the delivered dose uniformity (DDU) of drug from:

- a) Nebulisers as per USP chapter <1601> and Ph.Eur. 2.9.44 and
- b) Metered Dose Inhalers (MDIs) when used in conjunction with spacers and valved holding chambers as per USP chapter <1602>

2. Improved *in vitro* - *in vivo* correlations (IVIVCs)

To replace the fixed flow rate vacuum pump normally employed for regulatory testing with a unit capable of producing breath profiles more representative of conditions *in vivo*.

An MDI, when used without a spacer or VHC, actively delivers the drug directly to the patient using a propellant. With these devices, inhalation must be coordinated with the actuation to ensure success, but the shape and characteristics of the breathing profile employed by the patient in their use are unlikely to have much effect on the APSD of the delivered aerosol and/or the effectiveness of delivery.

This is not the case for dry powder inhalers (DPIs), nebulisers or MDIs used with spacers/ VHCs. Here the breathing profile of the patient directly influences the efficiency of drug delivery.

For this reason, more laboratories are turning to the use of breathing simulators to measure the effects of different profiles, flow rates and breathing techniques during their development.

Such an approach is supported by the Quality by Design (QbD) strategy outlined in ICH Q8 which relies on scoping the potential impact of any variability that may arise from, for example, differences in patient physiology or technique.

Copley produces a range of versatile breathing simulators, varying in functionality from the generation of simple sinusoidal patterns stated in USP and Ph.Eur. for nebuliser and MDI with spacer/VHC testing to complex user-generated profiles for advancing understanding as part of improving IVIVCs. The table below and following pages introduce each breath simulator and their intended applications.

BRS 1100	BRS 2100	BRS 3100
Volume (manually adjust): 0 to 800 mL	Volume (computer controlled): 0 to 900 mL	Volume (computer controlled): 0 to 5000 mL
Frequency: 12 - 40 bpm	Frequency: 0+ (upper defined by acceleration limit)	Frequency: 0+ (upper defined by acceleration limit)
I:E Ratio: 1:1, 1:2 or 1:3	I:E Ratio: variable	I:E Ratio: variable
Waveforms: Sinusoidal	Waveforms: Sinusoidal, Square, Triangular, User defined (flow vs time)	Waveforms: Sinusoidal, Square, Triangular, User defined (flow vs time)
Inhalation and exhalation profiles	Inhalation and/or exhalation profiles	Inhalation and/or exhalation profiles
Select start on inhalation or exhalation stroke	Start on inhalation or exhalation stroke User defined profiles (flow vs time)	Start on inhalation or exhalation stroke Userdefined profiles (flow vs time)
User Interface: Keypad & 4-line display	User Interface: Embedded computer (Windows 10)	User Interface: Embedded computer (Windows 10)
Uses: Testing Nebulisers (Ph.Eur. 2.9.44 and USP <1601>) Testing MDIs with Spacers/VHCs (USP <1602>)	Uses: Testing Nebulisers (Ph.Eur. 2.9.44 and USP <1601>) Testing MDIs with Spacers/VHCs (USP <1602>) Improving IVIVCs for MDIs with Spacers/VHCs and nebulisers: - With Filter Holder and Adapter (Dose Uniformity) - With Impactor and Mixing Inlet (APSD)	Uses: Limited testing of Nebulisers (Ph.Eur. 2.9.44 and USP <1601>) and MDIs with Spacers/VHCs-(USP <1602>) Improving IVIVCs for MDIs and DPIs: - With DUSA for MDI/DPI (Dose Uniformity) - With Impactor and Mixing Inlet (APSD)

Breathing Simulator Model BRS 1100 (0-800 mL Volume)



DESCRIPTION

The **Breathing Simulator Model BRS 1100** is a microprocessor controlled instrument which was designed specifically for generating the neonatal, infant, child and adult breathing patterns required for the **dose uniformity testing of nebulisers**, in accordance with ISO 27427:2013 “Anaesthetic & Respiratory Equipment - Nebulising Systems and Components”, Ph.Eur. chapter 2.9.44 “Preparations for Nebulisation: Characterisation” and USP chapter <1601> “Products for Nebulisation: Characterization”.

It can also be used to generate the profiles required in USP Chapter <1602> for testing “Spacers and Valve Holding Chambers used with Inhalation Aerosols” (see Table on facing page).

The unit can also be used in place of a standard vacuum pump with a cascade impactor such as the NGI or ACI and a Mixing Inlet (see photo above) to form a simple and inexpensive system for APSD studies.

The BRS 1100 has the following features:

- Piston/cylinder arrangement, driven by motor with accurate speed and position control
- Inlet/outlet port for direct connection to the dose filter holder and nebuliser, spacer or VHC
- Tidal volume of 0 - 800 mL (155 to 770 mL certified)
- Frequency adjustable between 12 and 40 breaths per minute
- Sinusoidal waveform

- Inhalation/Exhalation Ratio (I:E Ratio) of 1:1, 1:2 or 1:3
- Selectable start position (inhalation or exhalation) for spacers/VHCs
- Cycle number: 1-9999 breaths
- Cycle time: 0 to 8 hours
- Emergency cut-out facility in the event of a blocked inlet/outlet
- RS232 remote start capability

User interface with the BRS 1100 is menu driven by means of a membrane keypad fitted with a 4-line LCD.

The volume required is set by means of an adjustable linkage accessed by opening the hatch on the right hand side of the casing (see photo below). The scale is graduated directly in mL.





Volume is adjusted by means of a calibrated scale

Qualification Kit

Thereafter, all that is required to run a test is to specify:

- a) The number of breaths required or the duration of the test in terms of hours, minutes and seconds
- b) The operating speed in terms of breaths per minute (bpm)
- c) The I/E Ratio
- d) The start position (inhalation or exhalation and then select Run Method and OK).

The BRS 1100 measures 410 x 480 x 275 mm (w x d x h) and weighs 18 kg.

Tidal Breathing Pattern						
Parameter	Adult 1	Adult 2	Adult	Child	Infant	Neonate
Volume (mL)	770	500	500	155	50	25
Freq. (bpm)	12	13	15	25	30	40
I:E Ratio	1:2	1:2	1:1	1:2	1:3	1:3
USP <1601>	-	-	✓	✓	✓	✓
Ph.Eur. 2.9.44	-	-	✓	✓	✓	✓
USP <1602>	✓	✓	-	✓	✓	✓



Breathing Simulator Model BRS 1100 in use with a Delivered Dose Sampling Apparatus for Spacers and Valved Holding Chambers (VHCs)

Cat. No.	Description
9131	Breathing Simulator Model BRS 1100
9106B	IQ/OQ Documentation for BRS 1100/2100/3100
9105	BRS 1100/2100/3100 Qualification Kit
9107	Re-calibration of BRS 1100/2100/3100 Qualification Kit
9108	BRS 1100 Re-calibration Certificate

Breathing Simulator Model BRS 2100 (0-900 mL Volume)



↑ IVIVC System for Nebulisers with Mixing Inlet, NGI, NGI Cooler and Stand, Air Flow Controller and Breathing Simulator Model BRS 2100

DESCRIPTION

The **Breathing Simulator Model BRS 2100** is a second generation, advanced, embedded computer controlled breathing simulator, with up to **900 mL** volume, suitable for the testing of Nebulisers and MDIs with Spacers and Valved Holding Chambers (VHCs).

The BRS 2100 has been specifically designed to generate all of the breathing profiles used in measuring the drug delivery rate and total drug delivered of nebulisers according to Ph.Eur. 2.9.44 and USP <1601> (see Page 32), namely neonate, infant, child and adult.

It will also generate the neonate, infant, child, adult 1 and adult 2 breath profiles in the new USP Chapter <1602> for the *in vitro* assessment of Spacers and Valved Holding Chambers used with MDIs.

The BRS 2100 is also suitable for generating other wave forms used in improved IVIVC studies of nebulisers and other inhaled products requiring an inhalation volume of < 900 mL.

Flow rates can be displayed in mL/s or L/ min and there is a function to simulate uncoordinated product use, in the case of VHCs, by **starting the breathing profile on the exhalation portion of the profile.**

The control function is provided in the form of an embedded computer running **Windows 10** used in conjunction with a colour monitor, keyboard and mouse. USB and ethernet connections are provided for printing.

Standard breathing patterns can be defined by editing the following parameters:

- Selected Pattern: square, sinusoidal or triangular
- Tidal Volume: 0 - 900 mL (155 to 770 mL certified)
- Duration of inhalation (in seconds)
- Delay after inhalation (in seconds)
- Duration of exhalation (in seconds)
- Delay after exhalation (in seconds)
- Number of Breathing Cycles

The in-built software automatically calculates the:

- Duration of the test
- Breathing Frequency (bpm)
- Inhalation / Exhalation (I:E) Ratio (%) and displays all of the parameters on screen together with a graphic display of the pattern generated

Alternatively, the user can generate their own **Flow versus Time** profiles in the form of text files containing tabulated data points. Up to **1000 data points** can be entered, with time intervals as small as **20 milliseconds**, allowing the creation of high-resolution breathing profiles, (e.g. as measured in clinic).

Breathing patterns, which can consist of single or multiple breaths, with or without exhalation phases, can be saved and loaded into the software, as required. Selecting Start

activates the breathing cycle programme.

During operation, the current position within the cycle is indicated in the form of a rolling display on screen.

The BRS 2100 compensates for test equipment induced flow resistance experienced at the inlet, by adjusting power to the motor controlling the piston/cylinder arrangement. If the flow line becomes blocked, the BRS 2100 will automatically abort the test.

The BRS 2100 measures 750 mm (w) x 350 mm (d) x 700 mm (h).

Breathing Simulator Model BRS 2100 Set-up for the testing of Spacers and VHCs with Facemasks

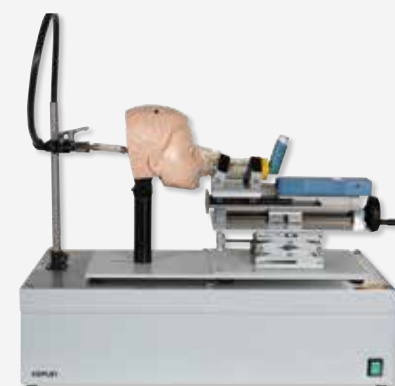

Breathing Simulator Model BRS 3100 (500 mL - 5 L Volume)



← IVIVC System for DPIs with Adult Alberta Idealised Throat, Mixing Inlet, NGI, Breathing Simulator Model BRS 3100, Air Flow Controller and Manifold

DESCRIPTION

The **Breathing Simulator Model BRS 3100** is similar in design and operation to the BRS 2100 except that it has a volume of **500 mL - 5 L** (certified).

It also features a maximum flow rate of **240 L/min** (free flow) and a maximum acceleration of **25 L/s²** (free flow) making it the ideal unit for the testing of MDIs and DPIs for improved IVIVCs.

Delivered Dose Uniformity (DDU) and Aerodynamic Particle Size Distribution (APSD) continue to be subjects of close scrutiny as the concept of Quality by Design (QbD) becomes more widespread. The emphasis is now on method development that uses design of experiments (DoE) to identify the most significant factors, the critical quality attributes (CQAs), relevant to the product concerned.

For this reason, laboratories are devoting more resources to method development in an attempt to try to establish improved IVIVCs at an early stage in the product design.

In the case of DDU measurements, clinical realism can be improved by connecting the Dose Unit Sampling Apparatus (DUSA) directly to BRS 3100 using an adapter (see below). This allows realistic patient profiles to be applied to DDU tests, rather than the constant flow rate testing associated with the use of a vacuum pump specified in USP/Ph.Eur. methods.

In the case of APSD measurements, a Mixing Inlet is required to decouple the variable flow through the inhaler (i.e. realistic patient profiles generated by the Breathing Simulator) from the steady-state flow rate required through the cascade impactor (see Page 72).

A Real-Time Breath Profile Verification Chamber is available (for use with USP induction port only) to allow measurement and recording of the breathing profile generated through the inhaler during the actual test itself, using the flow certifier incorporated into the Qualification Kit.

An **NGI Cooler Stand** is also available when using the BRS 2100 to perform improved IVIVC APSD tests for nebulisers.

The BRS 3100 measures 800 mm (w) x 400 mm (d) x 850 mm (h).



↑ Real Time Breath Profile Verification Chamber (with inhaler *in situ* during test) supported by the Accessory Support Stand on the Breathing Simulator BRS 3100



↑ BRS 1100/2100/3100 Qualification Kit

Cat. No. Description

9116	Breathing Simulator Model BRS 2100
9126	Breathing Simulator Model BRS 3100
9105	BRS 1100/2100/3100 Qualification Kit
9106B	IQ/OQ Documentation for BRS 1100/2100/3100
9107	Re-calibration of BRS 1100/2100/3100 Qualification Kit
9109	Real-Time Breath Profile Verification Chamber
9110	Accessory Support Stand for BRS 2100/3100
5025	NGI Cooler Stand for BRS 2100
9122	Adapter for BRS 2100/3100 use with DUSAs for MDIs and DPIs

Critical Flow Control



INTRODUCTION

The vast majority of Dry Powder Inhalers (DPIs) are classified as “passive” breath activated devices; that is to say, they rely solely on the patient’s inspiration to operate.

There is no necessity to co-ordinate breathing with the actuation - the patient simply inhales deeply to access the drug.

It follows that both the delivered and fine particle dose of DPIs are dependent on the strength and duration of the patient’s inspiration, a critical quality attribute (CQA) which must be simulated during the course of *in vitro* testing.

The testing of DPIs is further complicated by the fact that different inhalers provide varying degrees of **resistance to flow** i.e. some require more effort to inhale than others (see graph below).

TESTING *IN VITRO*

In the case of the *in vitro* testing of DPIs, the pharmacopoeias specify that the duration of a single inhalation cycle (equivalent to that of a typical user when inhaling the drug) be achieved through the use of a 2-way switching valve connected to a vacuum pump.

The operation of the switching valve, and hence the duration of the breathing cycle, is controlled by means of a timer.

One side of the valve is connected to either the sampling apparatus (in the case of delivered dose) or a cascade impactor (in the case of particle size determination) and the other to a vacuum pump.

In pre-test mode, the switching valve is in the closed position such that no flow passes through the test apparatus.

On initiation of the test, the 2-way valve switches such that flow now passes through the test apparatus and hence the inhaler

under test. On expiration of the pre-set time, the solenoid closes again and the “inhalation” cycle is complete.

FLOW RATE

In the *in vitro* case, the *in vivo* strength and duration of the user’s inspiration is broadly replicated by the flow rate used and the time for which the solenoid valve concerned remains open.

To establish the correct flow rate to be used, it is first necessary to establish the flow rate required to produce a pressure drop comparable with that found at the mouth of the user *in vivo* when using the particular inhaler being studied.

Both Ph.Eur. and USP suggest a pressure drop over the inhaler of 4 kPa as being broadly representative of the pressure drop generated during inhalation by patients using DPIs.

The pressure drop created by the air drawn through an inhaler can be measured directly by measuring the absolute pressure downstream of the inhaler mouthpiece and comparing this directly with atmospheric pressure.

Using a flow control valve, it is then a simple matter to adjust the flow rate from the vacuum pump to produce the required pressure drop of 4 kPa and then, by replacing the inhaler with a suitable flow meter, to measure the flow rate, Q, required to produce this pressure drop.

It is this flow rate, Q, that the Pharmacopoeias state should be used for the determination of both delivered dose and particle size.

The only exception to this criterion is that if the flow required to produce a 4 kPa pressure drop is >100 L/min, as for example in the case of particularly low resistance inhalers, then 100 L/min should be used.

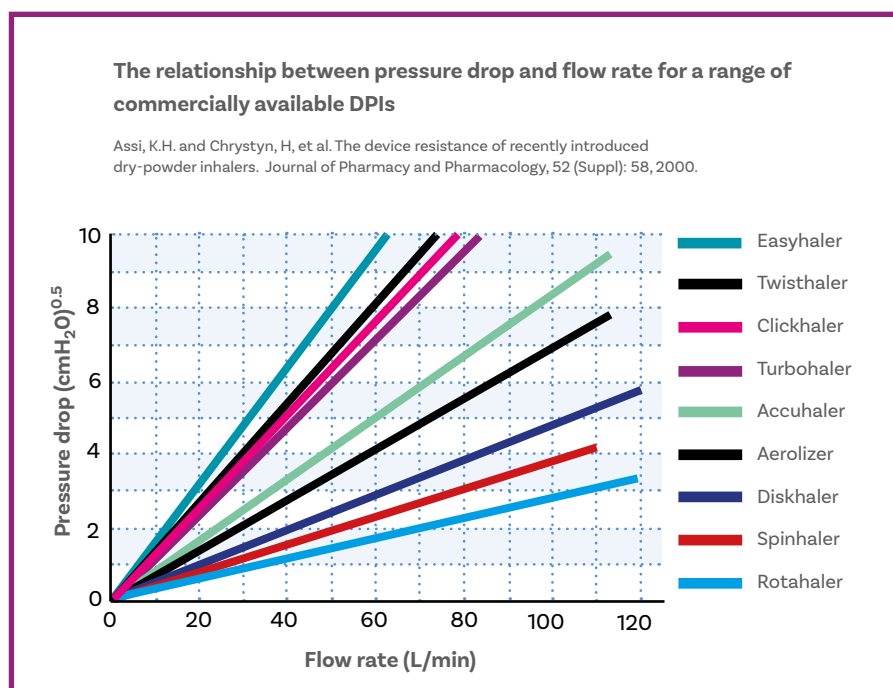

Critical Flow Control

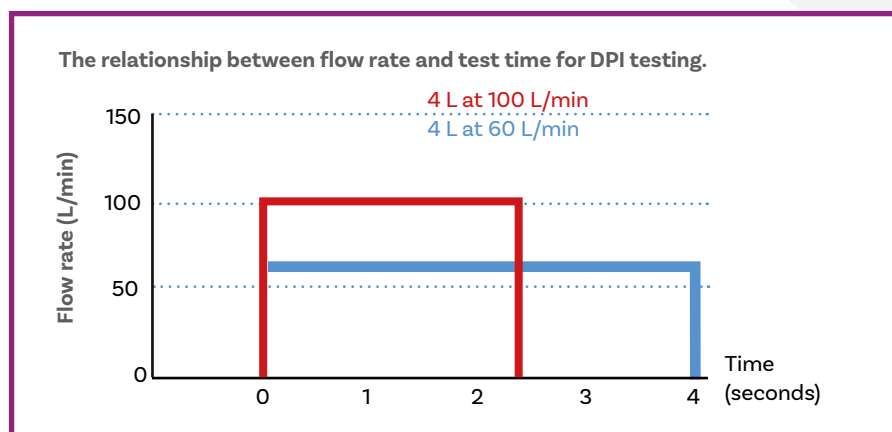

INSPIRATION VOLUMES

Once the flow rate, Q , has been established, it is now necessary to control the volume of air drawn through the inhaler during testing to the 4 litres per simulated inhalation required by the Pharmacopoeias (except for USP where 2 litres is required for DDU).

This is in order to simulate, as far as possible, the *in vivo* inspiration volume of the patient and is achieved by introducing a timer-controlled fast acting solenoid valve between the test device and the vacuum pump, as described on the preceding page.

4 litres is considered to be the normal forced inhalation capacity of an average sized male weighing approx. 70 kg. In practice, it is not uncommon to widen the scope of the test parameters to cover a broader target patient population, such as geriatrics and paediatrics, as well as those already suffering from pulmonary problems, including typical use and unintentional misuse conditions.

The solenoid valves used in the Critical Flow Controllers manufactured by Copley open and close in <25 milliseconds (the Pharmacopoeias state <100 milliseconds).

By using the timer to control the time that the solenoid valve is open, it is possible to control the volume of air drawn through the inhaler to achieve the volume specified (see diagram above).

For example, if the volume specified is 4 litres and the flow rate, Q , is 100 L/min then the timer should be set to 2.4 seconds. It follows that if Q is 60 L/min, then the timer should be set for 4 seconds, if Q is 30 L/min then the timer should be set at 8 seconds, etc.

CRITICAL (SONIC) FLOW

Having set the required parameters to control the strength and duration of the simulated breathing cycle, there is one final variable which needs to be considered: flow rate stability.

Ensuring stable flow throughout the test is critical to the testing of DPIs, since, as they are typically passive devices, they can be sensitive to small changes in flow rate.

A number of factors can influence flow rate stability particularly if the vacuum pump used is worn or working at the limits of its capacity.

An easy way to validate flow rate stability is to ensure that critical (sonic) flow occurs in the flow control valve concerned. This can be confirmed by simply measuring the absolute pressure at a point on either side of the flow control valve (see schematics below).

Providing that the pressure downstream of the valve is less than half of the upstream pressure i.e. that the ratio $P3/P2 \leq 0.5$ then critical (sonic) flow is assured and the flow rate can be assumed to be stable.

If this criterion cannot be achieved, it is likely that the vacuum pump is worn or is of insufficient capacity and should be repaired or replaced.

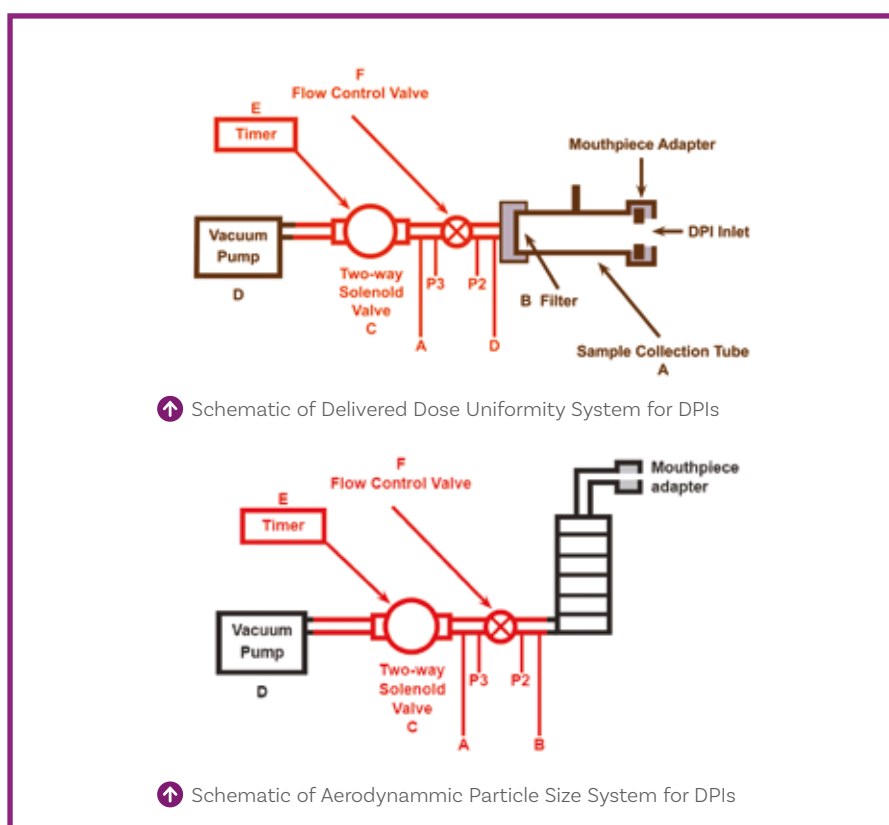

Critical Flow Control



↑ Critical Flow Controller Model TPK and TPK-R (Inlet/Outlet Reversed)

CRITICAL FLOW CONTROLLER MODEL TPK & TPK-R

In summary, a number of factors impact the test conditions applied for DPIs:

- The resistance to flow posed by the inhaler under test
- The appropriate flow rate, Q, required to generate a 4 kPa pressure drop over the inhaler
- The duration of inspiration required to give the specified test volume
- The stability of the flow rate in terms of critical (sonic) flow

The “Apparatus suitable for measuring the uniformity of delivered dose for powder inhalers” and the “Experimental set-up for testing powder inhalers” described in Ph.Eur. in chapters O671 and 2.9.18 respectively, “Apparatus B: Sampling apparatus for dry powder inhalers” and the “Apparatus 2,3, 4 or 5: General control equipment” described in USP Chapter <601> take all of these factors into account.

These specifications form the basis of the **Critical Flow Controller Model TPK**

and **TPK-R** (Inlet/Outlet reversed) which incorporates all of the components required into a single integrated system.

The main features of the TPK are as follows:

- Differential pressure meter for measuring pressure drop, P1 (Range: 0 to 100 kPa, Resolution: 0.1 kPa)
- Flow control valve to adjust flow rate
- Timer-controlled solenoid valve to adjust duration of flow (Range: 0 to 999.9 seconds, Resolution: 0.1 seconds)
- Absolute pressure meter for confirming sonic flow, P2 and P3 (Range: 0 to 100 kPa, Resolution 0.1 kPa)
- Membrane keypad control
- LED display of differential and absolute pressure values
- LCD back-lit display of set and elapsed actuation times

PROCEDURE

Delivered Dose Uniformity

Follow the procedure described under Delivered Dose Uniformity – Dosage Unit

Sampling Apparatus (DUSA) for DPIs (see Page 30).

Aerodynamic Particle Size Distribution

Use a cascade impactor (ACI, NGI or MSLI) together with the system components relevant to that particular impactor to perform this test.

Proceed as follows:

1. Assemble the appropriate system as shown in the schematic for testing the APSD of DPIs (see below)
2. Attach a suitable flow meter (see Page 88) to the inlet of the induction port
3. Switch on the pump and open the two-way solenoid valve
4. Adjust the flow control valve until the flow rate measured by the flow meter is equal to Q, as determined **either** during DDU measurements **or** by employing the Induction Port P1 Measurement Adapter (described on Page 100) in the absence of a DUSA for DPIs

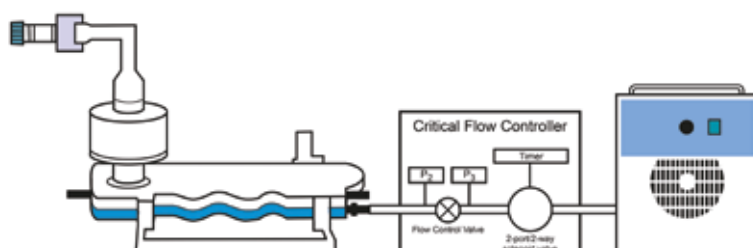

↶ Schematic of NGI System for testing DPIs including Critical Flow Controller (Inlet/Outlet Reversed option) and Pump

Critical Flow Control

4. Check that sonic flow is being achieved by pressing the keys relating to P2 and P3 and reading the results from the LED display. Close the solenoid valve and remove the flow meter
5. Using the TPK timer, adjust the test flow duration to give the inspiration volume required, for example, 4 litres
6. Insert the mouthpiece of the primed loaded inhaler into the inlet of the induction port using a suitable mouthpiece adapter (Page 90)
7. Discharge the powder into the impactor impinger by activating the timer, thus opening the solenoid valve
8. Now conduct the assay as appropriate to the apparatus concerned



Cat. No.	Description
8701	Critical Flow Controller Model TPK
8701-R	Critical Flow Controller Model TPK-R
8750	TPK Re-calibration Certificate
8752	Flow Time Verification Kit
8753	Re-calibration of Flow Time Verification Kit

Critical Flow Controller TPK/-R	Critical Flow Controller TPK 2100/-R (See page 84)
Manual Flow control valve for flow rate control	"Fly-by-wire" flow control valve with manual and automated modes
P1, P2 and P3 measurement	P1, P2, P3, PD & PA measurement
Electronic timer for control of solenoid valve	Integrated timer for control of solenoid valve
2-way/2-port solenoid valve	2-way/2-port solenoid valve
LED display of pressure only	4-line LCD display of all parameters
Membrane buttons for timer, P1, P2 and P3 with LEDs	Illuminated start button and multi-function keypad
P1 range 0-100 kPa, resolution 0.1 kPa	P1 range 0-15 kPa, resolution 0.01 kPa
P2 & P3 range 0-100 kPa, resolution 0.1 kPa	P2 (and PA) & P3 range 0-120 kPa, resolution 0.1 kPa
Timer range 0-999.9s, resolution 0.1s	Timer range 0-600.0s, resolution 0.1s
Solenoid valve opening/closing time 25/25 ms	Solenoid valve opening/closing time 25/25 ms
	High-speed automatic test set-up function
	Automatic calculation of P3/P2 ratio (sonic flow)
	Setting and counting the number of test actuations
	External temperature/humidity sensor module
	Flow meter DFM4 & DFM 2000 interface
	USB printer port interface for data output
	TTL interface for remote actuation (Footswitch/MDI Actuation Sensor)
	USB interface for data output and remote actuation
	User calibration function
	Storage of calibration time/date
	Total impactor Delta-P function (PD)
	Spacer/VHC testing actuation delay function
	Fully automated in situ impactor leak testing function with pass/fail
	Automated setting of P1 or flow rate (Q) during test set-up
	Critical Flow Controller TPK emulation function (basic run test mode)
	Automatic calculation of test duration from volume and flow rate
	Measurement and recording of P1 and P3/P2 for each actuation
	Inlet/In-line flow meter modes
	Warning if P3/P2 > 0.5, Q > 100 L/min and Q > 5% from set value
	Reports: Test set-up, Run test, Leak test, Delta-P and Calibration



TPK-R



TPK 2100-R

Critical Flow Control for DPIs



↑ Critical Flow Controller Model TPK 2100-R
(Inlet/Outlet Reversed)

↑ Critical Flow Controller Model TPK 2100 with
External Temperature/Humidity Sensor

CRITICAL FLOW CONTROLLER MODEL TPK 2100 & TPK 2100-R

The new, third generation **Critical Flow Controller Model TPK 2100** is designed to provide (and document) all of the critical parameters employed in the delivered dose uniformity (DDU) testing and aerodynamic particle size distribution (APSD) measurement of **Dry Powder Inhalers (DPIs)**.

Its predecessors, the Critical Flow Controller Models TPK and TPK 2000 have already become international standards in the field of DPI testing.

The Critical Flow Controller Model TPK 2100 conforms to the specifications laid down in Ph.Eur. Chapter 2.9.18 and USP Chapter <601> as listed in the table on Page 83, whilst incorporating a number of significant new improvements over its successful predecessor, the TPK 2000.

It can also be used as a Breath Actuation Controller (BAC) for testing Metered Dose Inhalers (MDIs) with Spacers/Valved Holding Chambers (VHCs) and breath-actuated MDIs in accordance with Ph.Eur. 0671 and USP Chapter <1602>.

Central to the latest system is a new “fly-by-wire” flow control valve which allows operation to be automated so that data generation is both more efficient and reproducible.

The valve can also be controlled manually for situations where the automatic features are not required or where manual control is preferred.

Inhaler pressure drop, P1, and test flow rate are accurately and rapidly set by the TPK 2100 during test set-up, whilst in-line flow measurement can be accommodated and *in situ* impactor leak testing is fully automated for the first time.

The user is **warned if the important P3/P2 ratio is greater than 0.5**, giving full confidence that tests are being conducted under sonic flow conditions, whilst notification is also given if the **set flow rate** and **impactor leak rate** are outside acceptance limits.

Data output to printer and computer are standard, with enhanced monitoring and reporting of critical in-test parameters, whilst remote control via USB allows the TPK 2100 to be integrated into larger automated systems where required.

Provision is also made to allow users to emulate the previous generations of TPK, promoting interchangeability and integration into existing standard operating procedures (SOPs).

Two versions of the unit are available. The **TPK 2100-R** (Reversed) is functionally identical to the TPK 2100 but the position of the pneumatic connections and control knob are reversed to improve connectivity between the critical flow controller and other inhaler testing equipment such as the Next Generation Impactor (NGI).

PROCEDURES

The TPK 2100 menu system automatically guides the user through the correct test

set-up procedure. Interaction with the unit is via a touch sensitive membrane keypad.

The instrument supports both the **inline flow meter** method as well as the more conventional **inlet flow meter** method specified by the Pharmacopoeia.

The TPK 2100 can be used with either the **DFM4** or **DFM 2000** (See Page 89), with RS232 communication between the flow meter and the TPK 2100.

Test Set-up - Delivered Dose Uniformity (DDU) of DPIs

- Enter the desired pressure drop for the inhaler concerned e.g. 4.0 kPa. The TPK 2100 will now automatically adjust the flow control valve to the required air flow dependent on the air resistance of the inhaler concerned. Select “OK”.
- Now replace the inhaler with a suitable flow meter (unless inline method used). The system now measures and records the air flow rate attained.
- The system constantly measures critical (sonic) flow conditions ($P3/P2 > 0.5$) throughout the process and alerts the user to any out-of-specification (OOS) conditions.
- If the flow rate required to generate the pressure drop is more than 100 L/min, then provision is made to automatically re-adjust the control valve back to 100 L/min as per the compendial instructions.



↑ TPK 2100 Display showing Automatic Setting of P1



↑ Example Test Setup Report

This also applies during impactor particle sizing when the test flow rate has already been predetermined during the DDU phase.

- The TPK 2100 now automatically measures and reports the test set-up parameters: P1, P2, P3, P3/P2 ratio, flow rate, temperature, RH, atmospheric pressure together with test set-up time, TPK 2100 and flow meter serial numbers and calibration data

Test Set-up - Aerodynamic Particle Size Distribution (APSD) of DPIs

- Connect a suitable flow meter (see Page 88) to the inlet of the impactor and turn on the vacuum pump
- Enter the flow rate required (e.g. 60 L/min). The system will now automatically adjust the flow control valve to give the set value
- A visual warning will be given if flow is outside +/- 5% of the requested flow or if the flow exceeds 100 L/min
- Comprehensive reporting and printout is available of all test set-up parameters if desired

Run Test (DDU or APSD of DPIs)

- Insert the inhaler into the sample collection tube or cascade impactor as appropriate and turn on the vacuum pump
- The unit now prompts the user to enter the required number of test actuations (shots). The number of shots are automatically monitored, displayed and reported during the test
- The duration of the test is **automatically**

calculated from the required volume (e.g. 4 litres). Provision is also made to input a delay to enable the testing of MDIs with spacers or VHCs if appropriate

- Actuations are triggered by pressing the illuminated 'RUN' button on the TPK 2100 front panel. This button is illuminated once the test parameters have been entered and repeated for each further actuation
- If desired, test actuations can be triggered remotely using the optional foot switch, MDI Actuation Sensor, USB input or external TTL trigger (for automation)
- During the test, the in-built software continuously measures and reports on critical (sonic) flow conditions and provides a visual indication of run time and shot count
- Provision to input a delay to enable the testing of MDIs with spacers is provided as standard

- A run test report is provided at the end of each test, recording P1 (optional) and P3/P2 ratio for each actuation (shot)

Other

- Optional **footswitch** and **temperature humidity module** for measuring environmental test conditions as recommended by USP
- Fully-automated, *in situ* **leak testing** of cascade impactors without the need for additional leak test equipment, encouraging leak testing prior to every test. A leak test report is also provided at the end of each test and performance reported against user defined pass/fail criteria
- Impactor **Total Delta-P** function (see Page 139)
- **User calibration** function with optional calibration kit (see Page 139)

Cat. No. Description

8790	Critical Flow Controller Model TPK 2100
8790-R	Critical Flow Controller Model TPK 2100-R
8769	Temperature and Relative Humidity Sensor
8791	TPK 2100/BAC 2100 Foot Switch
8797	MDI Actuation Sensor
8766	Printer
8793	TPK 2100 Re-calibration Certificate
8752	Flow Time Verification Kit
8753	Re-calibration of Flow Time Verification Kit

Breath Actuation Control for MDIs



↑ Breath Actuation Controller Model BAC 2100



↑ MDI Actuation Sensor for testing MDIs with Spacers/VHCs when using BAC 2100/-R

BREATH ACTUATION CONTROLLER MODEL BAC 2100 & BAC 2100-R

A cut-down version of the TPK 2100 and successor to the BAC 2000, the **Breath Actuation Controller Model BAC 2100** is an electrically operated, timer controlled two-way solenoid valve.

It is designed to provide (and document) all of the critical parameters measured in the delivered dose uniformity (DDU) testing and aerodynamic particle size distribution (APSD) measurement of Metered Dose Inhalers (MDIs).

In practice, it is positioned in the line between the DUSA collection tube/cascade impactor and the vacuum pump in order to control the air flow supply to the inhaler under test.

Two versions of the unit are available. The BAC 2100-R (Reversed) is functionally identical to the BAC 2100 but the position of the pneumatic connections are reversed to improve connectivity between the BAC and other inhaler testing equipment such as the Next Generation Impactor (NGI).

The BAC 2100/-R features the same flow meter, temperature and RH connections and printing capabilities as found on the TPK 2100/-R.

The unit is a microprocessor controlled instrument designed specifically for three test applications:

1) Conventional Metered Dose Inhalers (MDIs)

In addition to the specifications as laid down in Ph.Eur., the FDA recommends and USP specifies, that the volume of air sampled should not exceed 2 litres, when carrying out delivered dose uniformity testing on conventional MDIs, this being the volume of air adjudged to be typical of the inhalation of the average patient.

The BAC 2100/-R provides near instantaneous starting and stopping of the air flow during testing and has both delay and inhaled time functions.

This allows the time that the test flow is applied to the inhaler to be adjusted to a specific volume, for example, the 2 litres required by USP.

Operation is normally triggered by the **MDI Actuation Sensor** which clips on to most commercially available MDI canisters and connects directly to the BAC 2100 to allow precise synchronisation of MDI actuation and the onset of flow. Alternatively a footswitch can be used.

2) Breath-Actuated (or Breath Operated) Metered Dose Inhalers (MDIs)

The BAC 2100 is also a key element in determining the Delivered Dose Uniformity and Aerodynamic Particle Size Distribution of Breath-Actuated or Breath-Operated MDIs.

In this instance, the initiation of the flow triggers the inhaler such that sampling from the MDI occurs only at the predetermined flow rate.

The volume of air sampled (the breath) is the product of the flow rate (typically 28.3 or 30 L/min) and the time that the valve is open.

Breath Actuation Controller Model BAC 2100/-R

Integrated timer for control of solenoid valve	TTL interface for remote actuation (Footswitch/MDI Act. Sensor)
2-way/2-port solenoid valve	External temperature/humidity sensor module
4-line LCD display of all parameters	Flow meter DFM4 & DFM 2000 interface
Illuminated start button and multi-function keypad	USB interface for data output and remote actuation
Timer range 0-600.0s, resolution 0.1s	User calibration function
Solenoid valve opening/closing time 25/25 ms	Storage of calibration time/date
PA measurement (range 0-120 kPa, resolution 0.1 kPa)	Fully automated in situ impactor leak testing function with pass/fail
Setting and counting the number of test actuations	Automatic calculation of test duration from volume and flow rate
Spacer/VHC testing delay function	Inlet/In-line flow meter modes
USB printer port interface for data output	Reports: Test set-up, Run test, Leak test, Calibration



System for the APSD of MDIs

3) Spacers and Valved Holding Chambers (VHCs) used with MDIs

Used in conjunction with the **MDI Actuation Sensor** for the testing of the Spacers and Valved Holding Chambers (VHCs) commonly used with MDIs in accordance with the specifications as laid down in USP chapter <1602>.

Spacers and VHCs are add-on devices used in conjunction with MDIs to overcome the problems associated with poor, uncoordinated inhalation technique on the part of the user. This usually occurs when the patient delays inhalation rather than breathing in on actuation.

The draft chapter specifies two tests to determine aerodynamic particle size, Test Part 1A to measure the APSD under “optimal” conditions i.e., on actuation and Test Part 1B under “worst case” conditions that is to say with a delay of 2 or more seconds between inhaler actuation and sampling onset.

The BAC 2100/-R has both delay and inhaled time functions.

In the case of Test Part 1B, the flow is set at the usual test flow rate for MDIs (28.3 or 30L/min).

When called upon, the delay function is used to introduce the MDI aerosol into the spacer or VHC by starting the timer at the same time as actuating the MDI. Once the delay period has elapsed, the solenoid valve automatically opens to draw the aerosol into the cascade impactor. See Page 56 for further details.

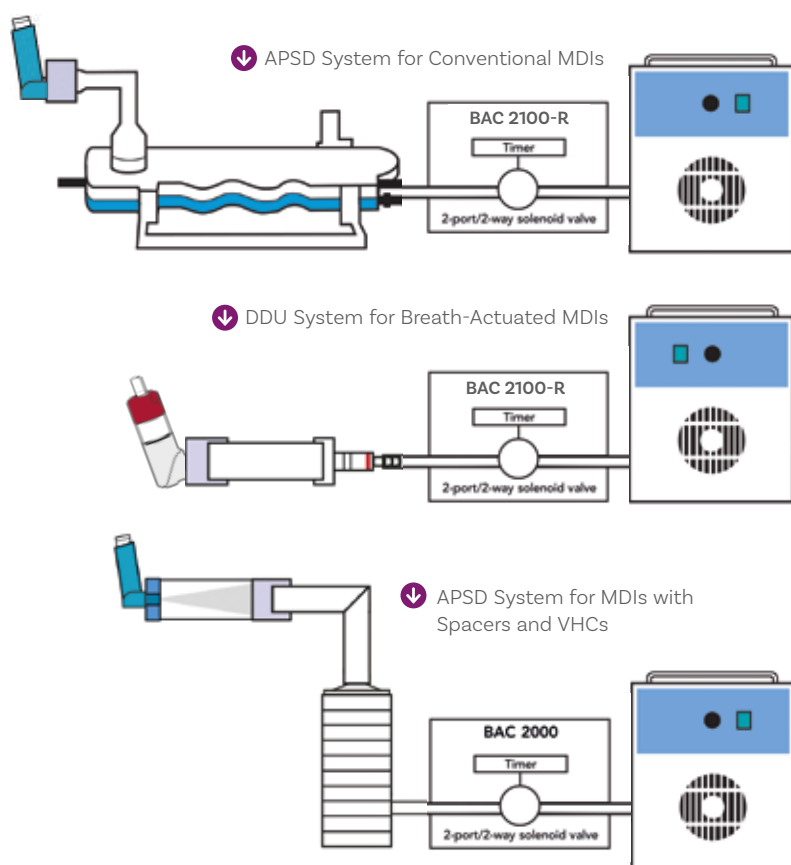

Note: The same functionality can be found on the TPK 2100/-R (described on Pages 84-85) and in the case of the Breath-Actuated/Operated MDIs by both TPK 2100/-R and TPK/-R (described on Pages 82-83). This is useful when testing DPIs also.

Cat. No.	Description
8795	Breath Actuation Controller Model BAC 2100
8795-R	Breath Actuation Controller Model BAC 2100-R
8769	Temperature and Relative Humidity Sensor
8791	TPK 2100/BAC 2100 Foot Switch
8797	MDI Actuation Sensor
8766	Printer
8783	BAC 2100 Re-calibration Certificate
8752	Flow Time Verification Kit
8753	Re-calibration of Flow Time Verification Kit

Flow Meters



↑ Flow Meter Model DFM 2000

INTRODUCTION

The Delivered Dose Uniformity (DDU) and Aerodynamic Particle Size Distribution (APSD) are two of the main Critical Quality Attributes (CQAs) in measuring the therapeutic efficacy of orally inhaled and nasal drug products (OINDPs).

Both DDU and APSD data can be severely compromised if the inlet flow rate (the flow rate at the entrance to the induction port or DUSA) used during testing is inaccurate and/or inconsistent, generating discrepancies with regard to its effects on both the cascade impactor itself and the inhaler under test.

Cascade impaction, the method used to measure APSD, divides the aerosol cloud into multiple size fractions on the basis of particle inertia which is a function of aerodynamic particle size and velocity.

In this technique, particle-laden air is drawn through a series of stages, each of which has a predetermined number of nozzles of defined diameter. Providing that the volumetric flow rate of the air stream remains constant, the air velocity increases from stage to stage.

Particles with sufficient inertia impact on the collection surface at a set distance beneath the nozzles while smaller particles are retained in the air stream and carried to the next stage. The result is a series of size fractions, typically between 0 and 10 microns.

The jet-to-plate distances on most commonly used impactors are fixed. Therefore, as long as the nozzle diameters remain within defined tolerances and

there are no leaks in the system, the cut-off diameter (the aerodynamic diameter of particles that accumulate on any given collection surface) of any given stage is directly related to the volumetric flow rate of the inlet air passing through it. A change in the flow rate results in a change in the aerodynamic particle size characteristics of the stage or stages concerned.

Indeed, a simplified version of Stokes' law, which describes the relationship between stage cut-off diameter, nozzle diameter and air flow rate, demonstrates that a 5% deviation in flow rate changes the stage cut-off diameter by approximately 2.5%. At a flow rate of 60 L/min, Stage 1 of an Andersen Cascade Impactor (ACI) should give a theoretical cut-off of 4.4 microns – increase that flow rate to 63 L/min and cut-off is effectively decreased to 4.3 microns.

The volumetric air flow can not only affect the ability of the cascade impactor to function correctly but also compromises the actual performance of the inhaler itself.

For many inhaled products the air flow drives the aerosolisation of the formulation and can therefore have a marked impact on how the dose disperses and hence on the resulting aerodynamic particle size determination.

In addition, for some devices, especially DPIs, the air flow through the device provides the motive force for dose delivery; indeed, some breath-actuated/operated devices trigger only when the flow rate through them exceeds a certain value.

DETERMINING THE PROPER TEST FLOW RATE

Although patient inspiration subjects inhalers to varying flow rates, cascade impaction requires a constant volumetric air flow. Within this constraint, the flow rate must, as far possible, reflect the conditions of use.

For propellant or pump-driven delivery, particle aerosolisation is generally insensitive to test flow rate. MDIs and the majority of nasal sprays are therefore normally tested at 28.3 L/min, equivalent to 1 cubic foot/min. The NGI, however, was calibrated at 30 L/min and should be operated at that rate for this type of device.



↑ Flow Meter Model DFM4

Flow Meters

Inspiration-dependent devices, where aerosolisation is sensitive to air flow, are more complex.

For DPIs, specifications call for a flow rate that induces a 4 kPa pressure drop across the device, typical for adult patient inspiration, or 100 L/min, whichever is lower. Because flow resistance differs from device to device, the easiest way to determine the correct flow rate for a particular DPI is to use a modified delivered dose sampling apparatus in conjunction with a flow controller that has the capacity to measure and record the required parameters.

For nebulisers, which rely on tidal breathing instead of a single forced inspiration, a flow rate of 15 L/min, the typical adult mid-inhalation flow rate, is employed.

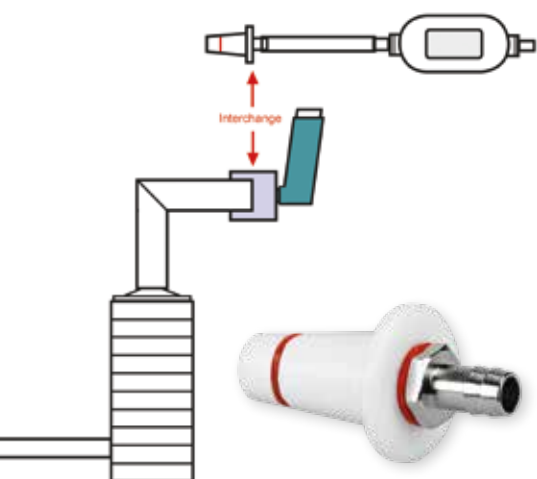

Flow Meter to Induction Port Adapter

PROCEDURE

The Pharmacopoeias specify that the test flow rate should lie within +/- 5% of the target flow.

To measure the required flow rate at the inlet of the impactor, the user must remove the mouthpiece adapter and the device under test from the induction port and replace it with an appropriate flow meter, which should be used to adjust the flow to the correct rate. The flow meter is connected to the induction port by means of a suitable adapter.

The flow meter must:

- Be capable of measuring volumetric flow (L/min) at the apparatus inlet
- Be calibrated for exit flow as opposed to inlet flow

Copley provides two flow meters that meet these criteria:

The **Flow Meter Model DFM4** operates on the Differential Pressure (Venturi) principle, has a range of 10-105 L/min, a resolution of 0.1 L/min and an accuracy of +/- 2% or 0.7 L/min whichever the greater.

Its robust design and method of operation means that an inlet filter is not required in routine use. A calibration kit is also available for routine calibration by the user.

The **Flow Meter Model DFM 2000** operates on the basis of the thermal mass principle, has a range of 0-200 L/min, a resolution of 0.01 L/min between 0 and 90 L/min (0.1 L/min between 90 and 200 L/min) and an accuracy of +/- 2% of flow rate. It is fitted with temperature and pressure sensors, in order to calculate the ambient volumetric flow rate and can also be used in-line (with supplied inlet filter).

Both units have RS232 interfaces that allow the communication of flow rate data to external devices, such as the Critical Flow Controller Model TPK 2100/-R and Breath Actuation Controller Model BAC 2100/-R.

Cat. No.	Description
8004	Flow Meter Model DFM4
8061	Re-calibration Certificate for DFM4
8005	Calibration Kit for DFM4
8006	Re-calibration of DFM4 Calibration Kit
8764	Flow Meter Model DFM 2000
8765	Re-calibration Certificate for DFM 2000

Flow Meter Model DFM4	Flow Meter Model DFM 2000
Portable Hand-Held	Portable Hand-Held
Venturi (Pressure Drop) Principle	Hot-Wire Mass Flow Principle
Metal flow tube with 12 mm hose fitting at outlet	Plastic flow tube with 1/2" hose fitting at inlet and outlet
Range: 10-105 L/min	Range: 0-200 L/min
Accuracy +/- 2% or 0.7 L/min whichever the greater	Accuracy +/- 2% of flow rate
Resolution: 0.1 L/min	Resolution: 0.01 L/min (0.1 L/min from 90 to 200 L/min)
Universal mains input voltage	Universal mains input voltage
Low flow Resistance (1.0 kPa @ 100 L/min)	High Flow Resistance (4.0 kPa @ 100 L/min)
Calibrated for outlet flow (preferred)	Calibrated for outlet flow (preferred)
Direct measurement of volumetric flow	Accurate calculation of volumetric flow from in-built T & P sensors
No inlet filter required	Inlet filter required in un-filtered laboratory environment
Cannot be used "in-line"	Can be used "in-line" (for non-pharmacopoeial methods)
RS232 Data Output (Flow Rate & Calibrate Date)	RS232 Data Output (Flow Rate & Calibrate Date)
Calibration kit available for user calibrations	Factory calibrations only

Mouthpiece Adapters



Copley mouthpiece adapters are specially moulded from high quality silicone rubber in order to guarantee an airtight seal between the inhaler under test and the test apparatus.

There is no standard mouthpiece adapter per se as each inhaler design is different. Adapters are available however for the more common devices on the market (see ordering information).

For other unlisted inhalers, we require a sample of the inhaler to be tested, so that a “cast” of the mouthpiece can be taken and an appropriate moulding tool produced. This moulding tool is used to mould the mouthpiece adapter(s) to that particular inhaler.

The tool is then supplied along with the mouthpiece adapter(s) to the user so that it can be reused should any additional mouthpiece adapters be required of that design, in the future.

Standard mouthpiece adapter colour is light blue, but other colours are available on request.

The induction ports used with the ACI, NGI and MSLI together with the DUSA for both MDIs and DPIs, the filter holder used with nebulisers and MDIs with spacers/VHCs, and the WSC2, all have the same external dimensions at the inlet. Therefore, the same mouthpiece adapter is transferable between all of these items types.

The Glass Twin Impinger and the Fluticasone Propionate (FP)/Salmeterol Induction Port have different external dimensions at the inlet and so require their own mouthpiece adapter, common to both.

The Adult Alberta Idealised Throat and Albuterol Aerosol SCA also require a larger mouthpiece adapter due to the larger inlet diameter, again common to both.

The Plume Temperature Tester PTT 1000 requires its own, shortened mouthpiece adapter.



↑ Induction Port with Diskus® Mouthpiece Adapter and Inhaler Support Accessory

Cat. No. Description

5003	Custom Mouthpiece Adapter for Induction Port, DUSA, WSC2, Filter Holder and Child Alberta Idealised Throat
5237	Custom Mouthpiece Adapter for Glass Twin Impinger and FP Induction Port
8515	Custom Mouthpiece Adapter for Adult Alberta Idealised Throat and Albuterol SCA
9013	Custom Mouthpiece Adapter for PTT 1000

Add suffix below to above Cat. No. for listed mouthpiece adapter:

C Easyhaler®	D Cyclohaler®
E Handihaler®	F Diskus®
G Novolizer®	H Rotahaler®
I Turbuhaler®	J Diskhaler®
K Respimat®	L Evohaler®
M Pari LC Plus®	N Trudell AeroChamber®
O Tobi Podhaler®	P Ellipta®
Q Symbicort® pMDI	R Nexthaler®
S Qvar® Autohaler®	T Flutiform®
U Airomir®	

5004	Tooling Charge for Custom Mouthpiece Adapter
5003X	Inhaler Support Accessory for Mouthpiece Adapter
5003Y	Mouthpiece Adapter Engraving (per Mouthpiece Adapter)
5022	Certificate of Conformance for Mouthpiece Adapter Material

Vacuum Pumps



← High Capacity Pump Model HCP5 (left) and Low Capacity Pump Model LCP5 (below)

INTRODUCTION

The Copley Low and High Capacity Pumps Models LCP5 and HCP5 are vacuum sources that have been specifically designed for use in the testing of MDIs, DPIs, nebulisers and nasal sprays in accordance with the specifications laid down in the European and US Pharmacopoeias.

The units represent the very latest in high performance, low maintenance, oil-free rotary-vane vacuum pump technology.

Foremost in the design specification were those features that you, the user, identified as being essential to inhaler testing, namely that the pump should:

- Be equipped with the correct fittings to link to other components in the test system
- Have sufficient capacity to provide the required test flow and in the case of DPIs to ensure critical (sonic) flow
- Have low noise levels, suitable for a laboratory environment
- Be low maintenance

Both pumps, for example, come with the appropriate fittings to connect to any inhaler testing system and to allow the user to position the pump to either right or left of that system depending on the available space on the laboratory bench. Provision is also made to vent the exhaust to an extraction system.

It should be noted that the resistance to flow imposed by the test apparatus, in conjunction with the requirement to achieve sonic flow in the case of DPIs, can reduce the effective capacity of the pump to less than 20% of the flow rate measured in free flow (unrestricted) conditions.

In practice, this means that in order to achieve 60 L/min sonic flow through the system a vacuum pump having a free flow of 300 L/min must be used. Even MDI systems provide significant resistance to flow typically in the region of 50% of free flow conditions.

Stable flow control is critical to good impactor measurement practice. This is because the aerodynamic particle sizing ability of inertial impactors is dependent on the velocity of the entrained particles as they

pass through each stage and that velocity is directly related to air flow.

For this reason, the Pharmacopoeias specify that, in the case of DPIs, critical (sonic) flow conditions are achieved within the system prior to testing, to ensure that the vacuum pump employed is of sufficient capacity for the task.

To meet these considerations the Copley LCP5 and HCP5 Pumps have been carefully designed to cover a range of free flow conditions between **133 and 833 L/min**.

Both pumps are fully encased with an internal acoustic lining and vibration damping to reduce noise levels to less than or equal to 60 dB (A).

Being oil-free, neither pump requires oil changes or regular replacement of oil filters.

Self-sealing compound carbon vanes continually adjust so that the pump effectively performs with "as new" efficiency throughout its service life.

Vacuum Pumps



← Backs of High Capacity Pump Model HCP5 (top) and Low Capacity Pump Model LCP5

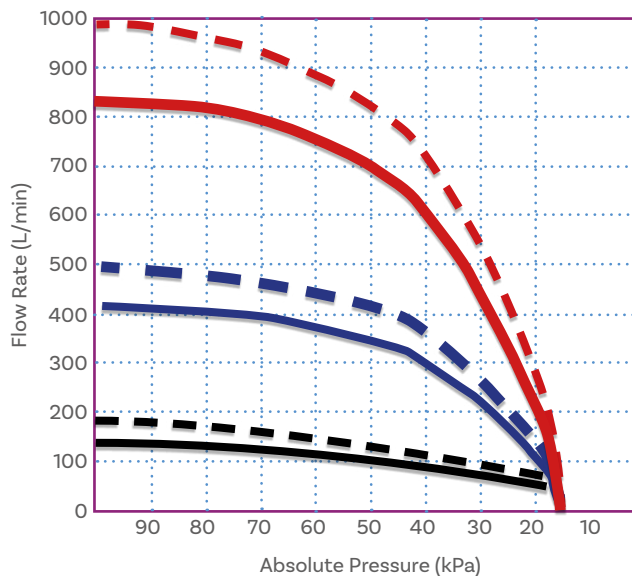

Performance Chart Key

- HCP5 (50 Hz)
- - HCP5 (60 Hz)
- 2 x HCP5 (50 Hz)
- - 2 x HCP5 (60 Hz)
- LCP5 (50 Hz)
- - LCP5 (60 Hz)

LOW CAPACITY PUMP MODEL LCP5

The Low Capacity Pump Model LCP5 is a small footprint vacuum pump designed for optimal operation at low flow rates.

This makes it ideal for **MDIs** and **Nasal Sprays** which are tested at 28.3 or 30 L/min and **Nebulisers** which are typically tested at 15 L/min. These devices do not generally require the use of a Critical Flow Controller. It is also suitable for the **Glass Twin Impinger** at 60 L/min, due to its low flow resistance.

In these instances, the test apparatus - the DUSA in the case of DDU testing and the cascade impactor in the case of APSD testing - is connected directly to the pump.

The unit contains a 0.35 kW motor capable of generating a maximum of up to 133 L/min free flow (at 50 Hz mains frequency).

The flow rate can be adjusted between 0 and 133 L/min free flow using the flow control valve mounted on the front panel.

The unit is provided with two vacuum inlets such that the user can decide whether to place the pump on the right or left side of the test system dependent on available bench space.

The LCP5 has an in-built cooling fan located on the top side of the pump and a ventilation grill on the bottom of the front panel. Two

handles are located on the top of the pump for lifting and positioning.

The pump measures 270 x 310 x 300 mm (w x d x h).

HIGH CAPACITY PUMP MODEL HCP5

The High Capacity Pump Model HCP5 is a well established high capacity pump for the higher, sonic flow rate testing requirements of **DPIs**, although it can equally well be used for MDIs, Nasal Sprays and Nebulisers.

Like the LCP5, an on/off switch and flow control valve are located on the front panel of the unit.

Two sets of vacuum inlets on either side of the pump allow the user to choose the location of the pump in relation to the test apparatus. Each set of vacuum inlets consists of a regulated and unregulated inlet.

The regulated inlet is connected to the pump

via the flow control valve and is used to regulate flow between 0 and 250 L/min for MDI, Nasal Spray and Nebuliser applications.

The unregulated inlet bypasses the flow control valve and is used in conjunction with the critical flow controller for DPI applications. It can achieve a maximum flow rate of up to 416 L/min.

In instances where this flow rate is still not adequate, it is possible to connect a second HCP5 in parallel to the primary pump to give a maximum unregulated flow rate of up to 833 L/min.

This is typically required when testing DPIs under sonic flow conditions with the NGL, at high flow rates. Appropriate hose fittings are supplied with all HCP5s to allow them to be operated in parallel.

The pump measures 320 x 560 x 390 mm (w x d x h).

Cat. No.	Description
7903	Low Capacity Pump Model LCP5
7904	Overhaul Kit for LCP5
7901	High Capacity Pump Model HCP5
7905	Overhaul Kit for HCP5

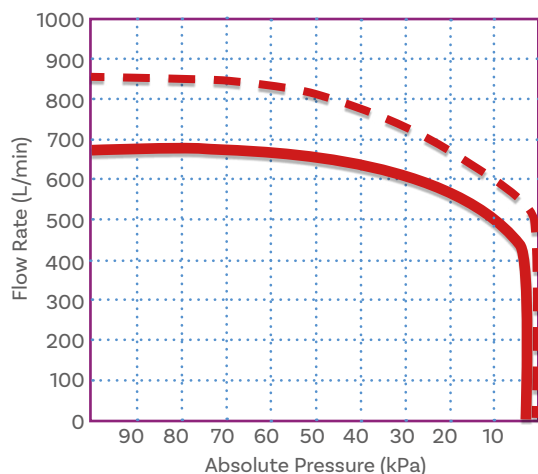

Performance Chart Key

- SCP5 (50 Hz)
- - - SCP5 (60 Hz)



SUPER CAPACITY PUMP MODEL SCP5

The Super Capacity Pump Model SCP5 is a bench-top vacuum pump for the laboratory capable of generating sonic ($P3/P2 \leq 0.5$) flow rates through the Next Generation Impactor (NGI) up to 100 L/min.

It is designed to provide a viable alternative to the use of two HCP5 Pumps to achieve these conditions.

The flow rate is controlled by means of a valve on the front panel of the unit. Two sets of vacuum inlets on either side of the pump allow the user to choose the location of the pump in relation to the test apparatus. Each set of vacuum inlets consists of a regulated and unregulated inlet.

The regulated inlet is connected to the pump via the flow control valve and is used to

regulate flow between 0 and 280 L/min for MDI, Nasal Spray and Nebuliser applications. A maximum unregulated flow of 683 L/min is available for DPI applications.

The vacuum is provided by an oil lubricated rotary vane pump having a 1.5 kW motor and exceptionally low noise levels for its size.

The SCP5 is fitted with two access panels to allow easy access for replenishing oil and changing the oil filter. A dual filtration

process, ensures that there is no oil vapour in the exhaust air, making it suitable for use in a laboratory environment.

The pump measures 420 x 600 x 450 mm (w x d x h).

Note: Special electrical supply requirements are necessary for UK and US applications. Please check details prior to placing your order.

Cat. No.	Description
7908	Super Capacity Pump Model SCP5
7909	Maintenance Kit for SCP5
7913	Replacement Lubricant (5 Litres) and Funnel for SCP5

Pump Model (50 Hz Version)	LCP5	HCP5	2 x HCP5	SCP5
Type	Rotary Vane	Rotary Vane	Rotary Vane	Rotary Vane
Lubrication Type	Dry	Dry	Dry	Oil
Max. Flow in L/min (unrestricted)	120	416	833	683
Max. Sonic Flow through NGI	N/A	80	100	100
Max. Vacuum Level	< 15 kPa	<15 kPa	<15 kPa	<0.1 kPa
Applications: Nasal	Yes	Yes	Yes	Yes
Nebulisers	Yes	Yes	Yes	Yes
MDIs	Yes	Yes	Yes	Yes
DPIs	No	Yes	Yes	Yes
Noise in dB (A)	55	60	70	65
Routine Maintenance	None	None	None	Oil/Filter Change
Dimensions (w x d x h)	27 x 31 x 30 cm	32 x 56 x 39 cm	74 x 56 x 39 cm	42 x 60 x 45 cm
Weight (kg)	18	45	90	70

CITDAS

Copley Inhaler Testing Data Analysis Software (CITDAS)

Introduction

USP Chapter <601> and Ph.Eur. Chapter 2.9.18 specify various types of multi-stage cascade impactor that can be used for measuring the particle size distribution of inhalers together with suggestions as to how the resulting data should be analysed. Hitherto, this data analysis has largely been performed using a variety of techniques with little attention being paid to standardisation and validation.

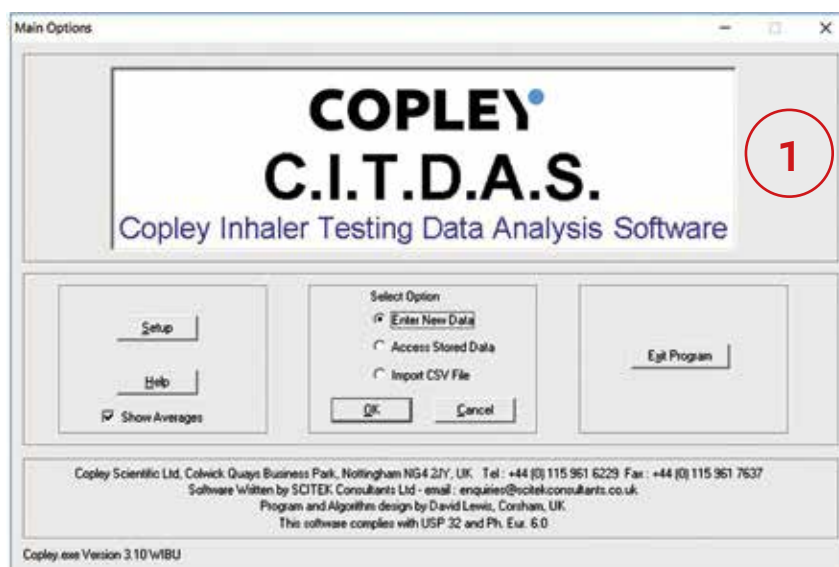

Copley Inhaler Testing Data Analysis Software (CITDAS)

Version 3.10

is a standardised approach to the entry, analysis and reporting of the Aerodynamic Size Distribution of drug output from MDIs, DPIs and Nebulisers in accordance with the USP and Ph.Eur.

Fully validated, the software will accept data from the Andersen Cascade Impactor, the Multi-Stage Liquid Impinger, the Marple-Miller Impactor and the Next Generation Impactor.

CITDAS Version 3.10 has been designed to run on Microsoft Windows Vista, XP, 7 and 8 operating systems. Installation is particularly quick and easy and does not require special IT knowledge.

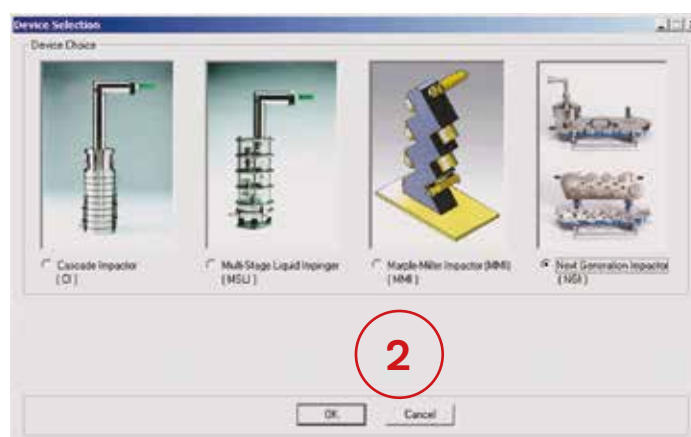

Simple Operation

On entering the program, the operator is prompted to select the source of the data to be analysed, whether new, stored or imported (1) and the type of impactor being used (2). One of the powerful new features incorporated into Version 3.10 of the software is the 'Import CSV file' facility which allows 'Comma Separated Variables' data input into CITDAS to be streamlined without the need for manual entry.

The system then defaults to the User Set-up Screen where the user is requested to fill in various information fields to identify themselves, the impactor being used and the inhaler(s) under test.

The majority of the fields are free-form and the field names can be customised in Maintenance Mode (there are two levels of access: operator and maintenance) to meet individual user requirements.

The same screen also contains the stages (3) and calibration data (4) applicable to the impactor being used (i.e. impactor stage Effective Cut-off Diameters [ECDs]). The software defaults to the stage ECDs recommended by the manufacturer of the impactor at that flow rate selected by the operator. This includes NGI calibration data for 15 to 30 L/min such that the software can now be used for nebulisers as well as MDIs and DPIs.

Alternatively, specific calibration data, as for example relating to that particular impactor, can be entered if desired and saved as a template.

The Deposition Data Screen provides fields for the entry of the drug deposition (5) recovered from the impactor stages in addition to:

- Dose No. - The number of the dose sampled from the inhaler
- Device - The drug deposition on the actuator/inhaler
- Flow Rate - The flow rate employed during operation (L/min)

- Doses to Device - The number of doses sampled by the device
- Delivered Dose - As determined during Delivered Dose Uniformity
- Number of Runs - Number of runs to be processed (1-12)

This screen also allows the user to select the number of runs to be processed (1-12) and the units of measurement in terms of μg or mg (6). Provision is also made for omitting the deposition data from the preseparator where it is not deployed and also, Stages 6 and/or 7 when using the ACI at flow rates greater than 60 L/min.

The number of runs to be processed can be adjusted between 1 and 12. Three runs are displayed per screen - further runs are accessed by means of the scroll bar.

The same screen allows the user to specify the criteria to be applied when calculating the Fine Particle Dose (FPD) and Geometric Standard Deviation (GSD). In the case of the FPD, this can be expressed in terms of either impactor stage or selected aerodynamic particle size (e.g. 5 microns).

One key feature of Version 3.10 that will be welcomed by users is the ability to define up to five fine particle dose/fraction groupings (7). Each group being defined by a range of either impactor stage or aerodynamic particle diameter (by interpolation).

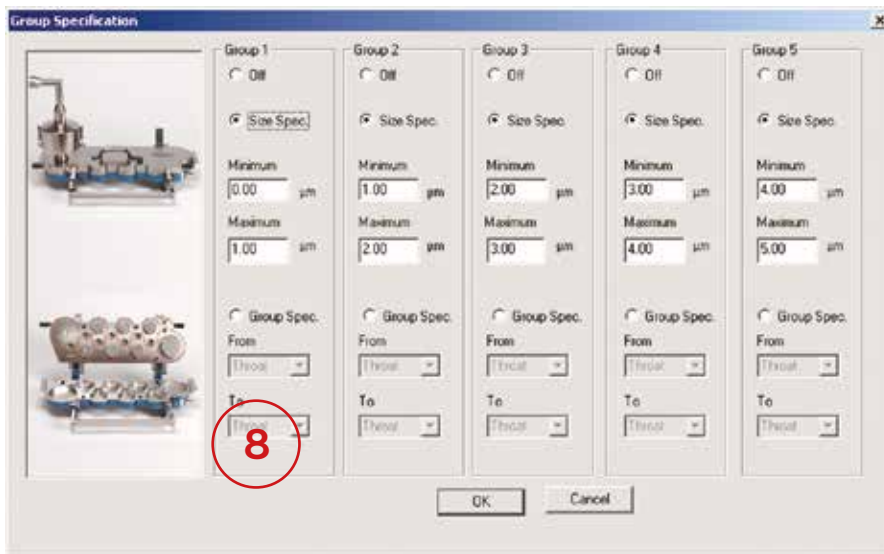
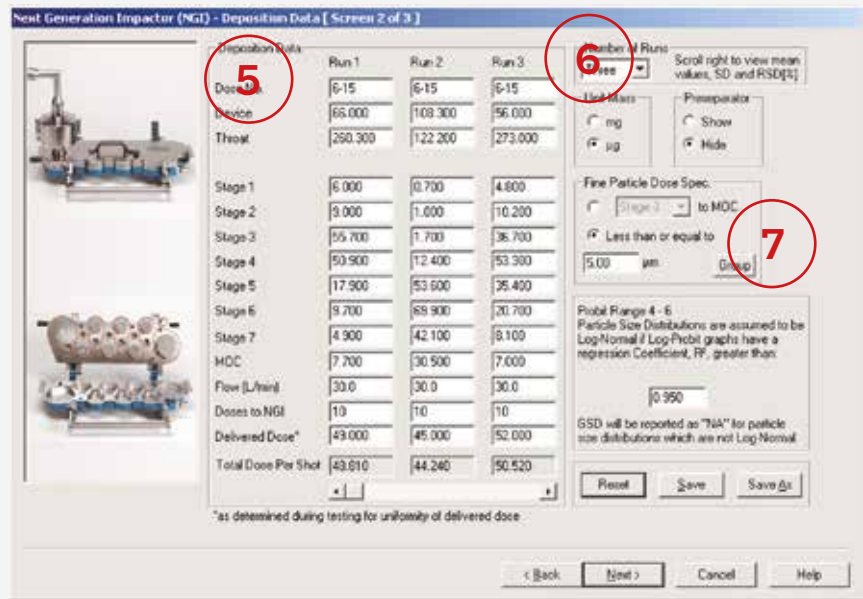

This means that in addition to reporting FPD values, it is now possible to routinely subdivide the reported delivered dose into up to five groupings based on stage or particle size. This includes the preseparator.

This facility is accessed through the Group button (7) on the Deposition Data screen which in turn reveals the Group Specification Screen (8).

The results of the various tests are calculated automatically and displayed on the Shot Weight Input & Results Summary Screen together with graphical representations (9) of the data for each run selected from the following options:

- Log Probability Graphs of Percentage of Mass Less than Stated Aerodynamic Diameter against Log AerodynamicDiameter
- Histograms of Drug Mass against Drug Distribution
- Cumulative Graphs of Percentage Drug Distribution against particle size.

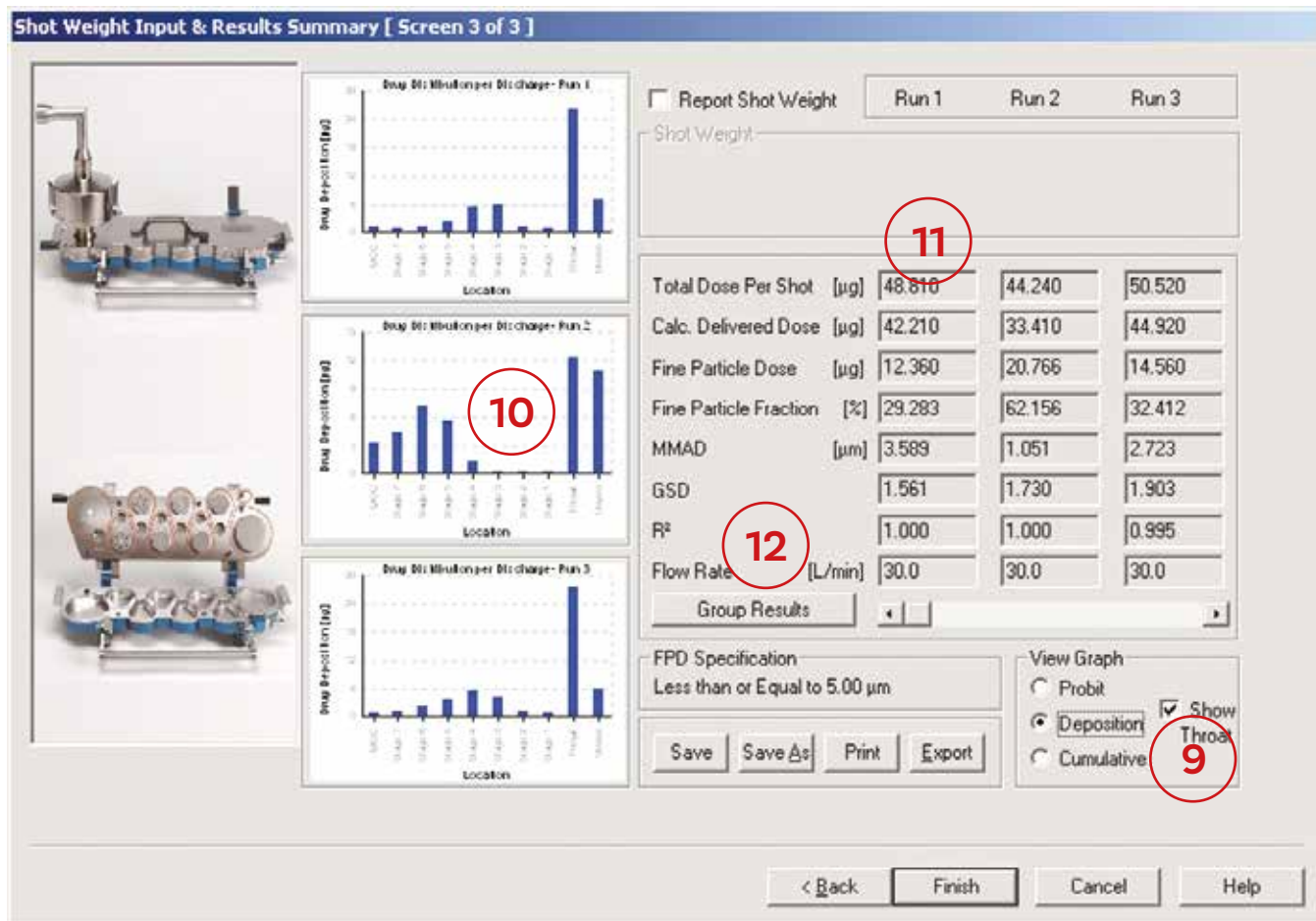

The drug deposition bar chart (10) can be viewed (and subsequently printed) with or without throat deposition. The same screen allows the user to input shot weights expressed in terms of the Mean and Standard Deviation for each particular run (11).

The following summarised data (12) is listed for each run:

- Total Dose per Shot [µg] or [mg]
- Delivered Dose [µg] or [mg]
- Fine Particle Dose [µg] or [mg]

- Fine Particle Fraction [%]
- Mass Medium Aerodynamic Diameter (MMAD) [µm]
- Geometric Standard Deviation (GSD)
- Particle Undersize log-probit graph (probit values 4-6)
- Regression Coefficient (R²)
- Device Sampling Flow Rate [L/min]

Version 3.10 also provides the facility to display, print or output 'Mean/dose', 'SD/dose' and '%RSD/dose' data at the end of

the 12 runs. This data can be accessed by scrolling right at data entry.

The Group Results Screen (overleaf) can be accessed through the Group Results button positioned below the summarised data fields.

It gives up to 5 stage groupings (13), between two stages or between two particle sizes in each case. The group results can be printed on a separate printout.

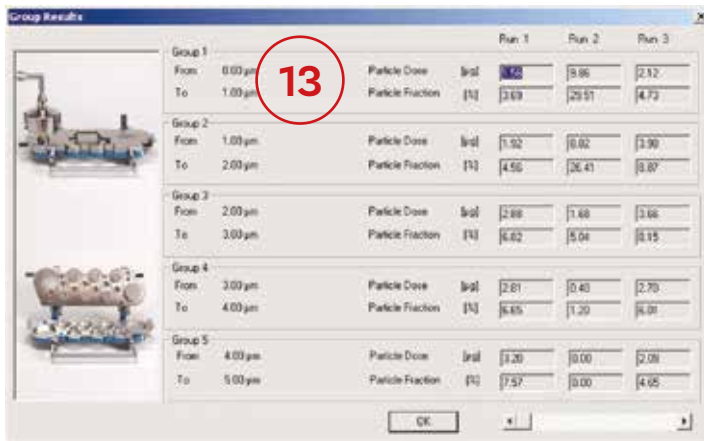

PRINTOUT FORMATS

CITDAS now has five printout types

allowing the user to present data in five different formats:

- European Pharmacopoeia format
- United States Pharmacopoeia format
- Graphical Summary
- Tabular Summary
- Group Results

All of the printout formats are located on a special Print Screen (15) which is accessed

by pressing the Print Button (14) on the Shot Weight Input and Results Summary Screen.

Examples of the various printouts may be found on Page 97. In response to customer feedback, Version 3.10 includes three significant improvements on earlier versions:

- Improved Accuracy (MMAD within +/- 0.003% of actual, GSD within +/- 0.007% of actual and FPD within 0.06% of total drug mass per dose)
- Mass balance calculations on USP and Ph.Eur. printouts expanded from

75-125% to also include 80-120% and 85-115% to meet FDA requirements

- Tabular summary now includes raw data input to allow cross check against output data on the same printout
- Limit of Detection (LOD) introduced to improve robustness and data integrity for narrow particle size distributions

SUMMARY OF KEY FEATURES

- Standardised approach to the analysis of impactor data
- Accepts data from ACI, MSLI, MMI and NGI
- Instant comparison of up to 12 runs
- Auto-correction of results to allow for impactor calibration differences and/or differing flow rates
- Fine Particle Dose (FPD) selection based on either impactor stage or aerodynamic particle size (e.g. 5 µm)
- Shot weight report option
- Automatic calculation of FPD, FPF, MMAD and GSD
- On-screen graphs in either histogram, log probability or cumulative formats

- Full printouts in both Ph.Eur. and USP formats, incl. graphical, tabular and group summaries
- Fully updated to reflect the definitive archival calibration of the NGI at 15 L/min so as to include Nebulisers
- Facility to import/export data as CSV files for manipulation in Microsoft Excel or similar software packages
- Stage groupings

CITDAS is supplied as standard with full supporting validation documentation, which provides verification of the correct storage of input parameters and details of the algorithms, methods and conclusions employed to calculate the results.

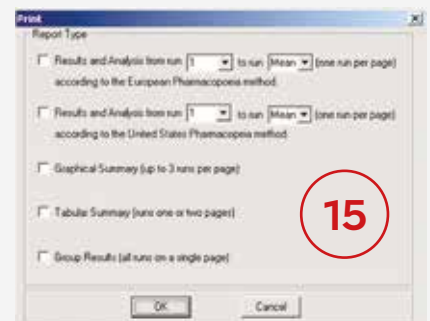

A **Waters Empower™** spreadsheet is now available on request to all CITDAS V3.10 users. This automatically converts files generated by Empower into CSV files, suitable for import into CITDAS, thus removing the need for manual data input.

Cat. No.	Description
8250	Copley Inhaler Testing Data Analysis Software (CITDAS) V3.10

Results and Analysis (EP Method) for Next Generation Impactor

Date of Analysis: 1/1/2000
 Analyst: J Smith
 Instrument Serial No: 123
 Device Details: Three JMKs
 Device ID Code: A, B, & C
 Batch Number: 9901, 9902, 9903
 Sample Age: As supplied

Storage Conditions: Ambient
 Formulation Details: Drug/Dose: 50mg, 50mg, 50mg
 Component 1: As Supplied
 Component 2: As Supplied
 Component 3: As Supplied
 Component 4: As Supplied
 Component 5: As Supplied

Other Info:
 Run Number = 10
 Number of discharges = 10
 Sampling Flow rate (l/min) = 30.0

Cut-off Diameter (µm)	Mass of active ingredient deposited per discharge (µg)	Cumulative mass of active ingredient deposited per discharge (µg)	Cumulative fraction of active ingredient deposited per discharge (%)
0.541	1.307	1.307	0.220
0.854	1.837	3.143	0.340
1.250	3.243	6.387	0.479
1.750	2.088	8.475	0.518
2.500	3.887	12.362	0.525
3.540	2.137	14.500	0.525
4.750	2.137	16.637	0.525
6.300	6.579	23.216	0.525
8.100	0.369	23.585	0.525

Log-Probit Graph Regression:
 Intercept = 4.201
 Slope = 2.412
 R² = 0.998
 N = 4

File Name: NDI_EXAMPLE_DATA.CPL
 Data Input by: [Date]
 Data Checked by: [Date]

Copy file Version 3.00 (WBU) Page 1 of 1 Wed Oct 21 14:12:38 2009

Ph.Eur. Method (1 run per page)

Results and Analysis (USP Method) for Next Generation Impactor

Date of Analysis: 1/1/2000
 Analyst: J Smith
 Instrument Serial No: 123
 Device Details: Three JMKs
 Device ID Code: A, B, & C
 Batch Number: 9901, 9902, 9903
 Sample Age: As supplied

Storage Conditions: Ambient
 Formulation Details: Drug/Dose: 50mg, 50mg, 50mg
 Component 1: As Supplied
 Component 2: As Supplied
 Component 3: As Supplied
 Component 4: As Supplied
 Component 5: As Supplied

Other Info:
 Run Number = 10
 Number of discharges = 10
 Sampling Flow rate (l/min) = 30.0

Stage	Mass A (µg)	Mass B (µg)	Cum. % of mass less than stated diameter	<D50 (µm)
MOC	1.307	1.307	0.220	0.541
Stage 1	1.837	1.837	0.479	0.854
Stage 2	3.243	3.243	0.518	1.250
Stage 3	2.088	2.088	0.525	1.750
Stage 4	3.887	3.887	0.525	2.500
Stage 5	2.137	2.137	0.525	3.540
Stage 6	2.137	2.137	0.525	4.750
Stage 7	6.579	6.579	0.525	6.300
Stage 8	0.369	0.369	0.525	8.100
Sum of Masses	40.180 (A)	18.320 (B)		

Log-Probit Graph Regression:
 Intercept = 4.201
 Slope = 2.412
 R² = 0.998
 N = 4

File Name: NDI_EXAMPLE_DATA.CPL
 Data Input by: [Date]
 Data Checked by: [Date]

Copy file Version 3.00 (WBU) Page 1 of 1 Wed Oct 21 14:12:38 2009

USP Method (1 run per page)

Graphical Summary for Next Generation Impactor

Date of Analysis: 1/1/2000
 Analyst: J Smith
 Instrument Serial No: 123
 Device Details: Three JMKs
 Device ID Code: A, B, & C
 Batch Number: 9901, 9902, 9903
 Sample Age: As supplied

Storage Conditions: Ambient
 Formulation Details: Drug/Dose: 50mg, 50mg, 50mg
 Component 1: As Supplied
 Component 2: As Supplied
 Component 3: As Supplied
 Component 4: As Supplied
 Component 5: As Supplied

Other Info:
 Run Number = 10
 Number of discharges = 10
 Sampling Flow rate (l/min) = 30.0

File Name: NDI_EXAMPLE_DATA.CPL

Copy file Version 3.00 (WBU) Page 1 of 2 Wed Oct 21 14:12:38 2009

Graphical Summary (3 runs per page)

Tabular Summary for Next Generation Impactor

Date of Analysis: 1/1/2000
 Analyst: J Smith
 Instrument Serial No: 123
 Device Details: Three JMKs
 Device ID Code: A, B, & C
 Batch Number: 9901, 9902, 9903
 Sample Age: As supplied

Storage Conditions: Ambient
 Formulation Details: Drug/Dose: 50mg, 50mg, 50mg
 Component 1: As Supplied
 Component 2: As Supplied
 Component 3: As Supplied
 Component 4: As Supplied
 Component 5: As Supplied

Other Info:
 Run Number = 10
 Number of discharges = 10
 Sampling Flow rate (l/min) = 30.0

Run No.	Dose No.	No. of Doses Sampled	Flow Rate (l/min)	Device (µm)	Throat (µm)	Presep. (µm)	Stage 1 (µm)	Stage 2 (µm)	Stage 3 (µm)	Stage 4 (µm)	Stage 5 (µm)	Stage 6 (µm)	Stage 7 (µm)	MOC (µm)
1	6-15	10	30.0	68.000	290.300	0.000	6.000	9.000	55.700	99.000	17.000	9.700	4.900	7.700
2	6-15	10	30.0	108.300	122.000	0.000	0.700	1.000	1.700	12.400	99.000	69.000	40.100	30.500
3	6-15	10	30.0	95.000	273.000	0.000	4.800	10.200	36.700	93.300	35.400	30.700	8.100	7.200
Mean	-	-	30.0	7.677	21.660	0.000	0.363	0.673	3.137	3.687	3.583	3.343	1.837	1.987

Run No.	Dose No.	No. of Doses Sampled	Flow Rate (l/min)	Material (µg)	Delivered (µg)	Dose (µg)	Fine Particle (%)	MMAD (µm)	GSD	R ²	Log-Probit Graph Regression Intercept	Slope		
1	6-15	10	30.0	6.930	26.000	0.000	0.800	6.570	5.080	1.790	0.976	0.490		
2	6-15	10	30.0	10.000	12.200	0.000	0.070	0.100	0.170	1.240	5.390	6.990		
3	6-15	10	30.0	5.000	27.300	0.000	0.480	1.050	3.670	5.530	3.340	2.030		
Mean	-	-	30.0	7.677	21.660	0.000	0.363	0.673	3.137	3.687	3.583	3.343	1.837	1.987

Log-Probit Graph Regression:
 Intercept = 4.201
 Slope = 2.412
 R² = 0.998
 N = 4

File Name: NDI_EXAMPLE_DATA.CPL
 Data Input by: [Date]
 Data Checked by: [Date]

Copy file Version 3.00 (WBU) Page 1 of 1 Wed Oct 21 14:12:40 2009

Tabular Summary (All runs on 1 to 2 pages)

Group Results for Next Generation Impactor

Date of Analysis: 1/1/2000
 Analyst: J Smith
 Instrument Serial No: 123
 Device Details: Three JMKs
 Device ID Code: A, B, & C
 Batch Number: 9901, 9902, 9903
 Sample Age: As supplied

Storage Conditions: Ambient
 Formulation Details: Drug/Dose: 50mg, 50mg, 50mg
 Component 1: As Supplied
 Component 2: As Supplied
 Component 3: As Supplied
 Component 4: As Supplied
 Component 5: As Supplied

Other Info:
 Run Number = 10
 Number of discharges = 10
 Sampling Flow rate (l/min) = 30.0

File Name: NDI_EXAMPLE_DATA.CPL

Run No.	Material (µg)	Delivered (µg)	Dose (µg)	Fine Particle (%)	MMAD (µm)	GSD	R ²	Log-Probit Graph Regression Intercept	Slope
1	6.930	26.000	0.000	0.800	6.570	5.080	1.790	0.976	0.490
2	10.000	12.200	0.000	0.070	0.100	0.170	1.240	5.390	6.990
3	5.000	27.300	0.000	0.480	1.050	3.670	5.530	3.340	2.030
Mean	7.677	21.660	0.000	0.363	0.673	3.137	3.687	3.583	3.343

Log-Probit Graph Regression:
 Intercept = 4.201
 Slope = 2.412
 R² = 0.998
 N = 4

File Name: NDI_EXAMPLE_DATA.CPL
 Data Input by: [Date]
 Data Checked by: [Date]

Copy file Version 3.00 (WBU) Page 1 of 1 Wed Oct 21 14:12:38 2009

Group Results (all runs on 1 page)

Sundries

SPARE / ADDITIONAL TUBING

Used to provide the connections between the various components making up your inhaler testing system. The 3 mm tubing is used to provide the P1 connection between the DUSA for DPIs and the Critical Flow Controller.

Cat. No.	Description
5015	10 mm i.d. PVC Tubing (per metre)
5016	16 mm i.d. Wire Reinforced PVC Tubing (per metre)
5017	3 mm i.d. PVC Tubing (per metre)

QUICK RELEASE CONNECTORS

A range of quick release connectors in polypropylene or stainless steel in two sizes, 12 mm and 17 mm designed for use with 10 mm i.d. and 16 mm i.d. tubing respectively for rapidly disconnecting test equipment from ancillaries.

Cat. No.	Description
5018	12 mm Quick Release Connector in Polypropylene
5019	17 mm Quick Release Connector in Polypropylene
5020	12 mm Quick Release Connector in Stainless Steel
5021	17 mm Quick Release Connector in Stainless Steel

DEVICE FLOW RESISTANCE MEASUREMENT

A simple device that is placed between the inhaler and the induction port and is used in conjunction with a Critical Flow Controller to measure the pressure drop (P1) over the inhaler under test, in the absence of a DUSA for DPIs.

Cat. No.	Description
8502	Induction Port P1 Measurement Adapter

RINSING CAPS

Silicone rubber and 316 stainless steel rinsing caps are available for capping off the open ends of the FP, ACI and NGI induction ports and the NGI preseparator during manual drug recovery. Simple rubber stoppers are also available.

Cat. No.	Description
8503	Set of 2 Silicone Rubber Rinsing Caps for FP Induction Port
8504	Set of 2 Silicone Rubber Rinsing Caps for ACI Induction Port
5265	Set of 2 Silicone Rubber Rinsing Caps for NGI Induction Port
5266	Set of 2 Silicone Rubber Rinsing Caps for NGI Preseparator
5227	Set of 2 Stainless Steel Rinsing Caps for NGI Induction Port
5228	Set of 2 Stainless Steel Rinsing Caps for NGI Preseparator
5232	Set of 2 Silicone Rubber Stoppers for NGI I.P./Preseparator



↑ Quick Release Connectors in use



← Tubing



↑ Quick Release Connectors



↑ Induction Port P1 Measurement Adapter

↓ Rinsing Caps



Special Applications

Introduction

The purpose of this section in the brochure is to cover those aspects of inhaler testing equipment that cannot otherwise be categorised in the sections under Delivered Dose Uniformity and Aerodynamic Particle Size.

DISSOLUTION TESTING

Dissolution Testing is widely employed in the development and manufacture of oral dosage forms such as tablets and capsules which rely on the drug dissolving in the fluids of the gastrointestinal tract prior to absorption into systemic circulation.

In the case of inhaled and nasal drug delivery products, the first prerequisite is to deliver an appropriate amount of drug to the target site. For that reason, *in vitro* testing is concentrated on drug delivery (emitted dose) and lung or nasal deposition (APSD) as opposed to dissolution or drug release.

Once deposited, the absorption or lung uptake, and hence the therapeutic effectiveness of the drug, depends on the active dissolving in the small amounts of aqueous fluid and lung surfactant available at the target site.

Designing a standardised method relevant to the lung is not easy because of the small amount of aqueous fluid involved and the presence of endogenous lung surfactants.

The method described on Page 102 provides one possible solution to this problem.

GENERIC DRUG DEVELOPMENT

In recent years, there has been increased interest in the development of generic OIPs as the patents on the original formulations expire.

This generic drug development has led to the reintroduction into the Pharmacopoeia of some of the test methods employed in the development of the original drugs.

Four such methods, and the test equipment required to perform them, now embedded in USP and relating to **albuterol** (aerosol), **fluticasone propionate** (aerosol and powder), **salmeterol** (powder) and **fluticasone propionate/salmeterol combinations** (aerosol and powder) are described on Pages 106-110.

The test equipment concerned comprises three Glass Sample Collection Apparatuses for the DDU testing of aerosols (MDIs) and powders (DPIs) and a modified Andersen Cascade Impactor (ACI) for APSD studies.

COLD FREON®

Users of Metered Dose Inhalers (MDIs) may well be familiar with the “cold Freon®” effect - the inadvertent reaction to the chilling sensation that hits the back of the throat following actuation of the device.

Caused by impaction of the delivered dose and the rapid evaporation of any remaining propellant, the “cold Freon®” effect strongly influences the efficiency of drug delivery.

It may, for example, cause the patient to abort or be unsuccessful in completing the inhalation manoeuvre.

The “cold Freon®” effect is a function of **aerosol spray force** and **plume temperature**.

Copley offers two instruments designed to quantify these two parameters: the **Spray Force Tester**, which measures the force caused by high velocity impaction at a range of user-defined distances from the origin of the plume, and the **Plume Temperature Tester**, for measuring temperature under controlled laboratory conditions.

Both units are described on Pages 111 and 112.

Dissolution Testing

INTRODUCTION

Dissolution is a Critical Quality Attribute (CQA) for the development and manufacture of oral dosage forms such as tablets and capsules, which rely on the drug dissolving in the fluids of the gastrointestinal tract prior to absorption into the systemic circulation.

Indeed, dissolution testing is widely used for optimising efficacy during development (often by using modified or controlled release techniques), ensuring quality during batch to batch manufacture and in some cases to predict bioavailability *in vivo* and assess bioequivalence.

In the case of inhaled and nasal drug delivery products, the first prerequisite is to deliver an appropriate amount of drug to the target site. For that reason, *in vitro* testing is concentrated on drug delivery (emitted dose) and lung or nasal deposition (APSD) as opposed to dissolution or drug release.



← Dissolution Tester Model DIS 800i



Once deposited, the absorption or lung uptake, and hence the therapeutic effectiveness of the drug, depends on the active dissolving in the small amounts of aqueous fluid and lung surfactant available at the target site.

At present, there are no official dissolution test methods described that are applicable to inhaled products. One of the main problems facing the developers of such methods is the identification and segregation of that part of the total emitted dose actually reaching the target site (as opposed to the whole dose) in a form readily adaptable to conventional dissolution testing techniques.

Copley offers USP Method 2 dissolution testers for use with the NGI and ACI Membrane Holders (featured on following pages), details of which can be found in our sister brochure "Driving Results in Pharmaceutical Testing".

← Membrane Holder in Dissolution Vessel

NGI and ACI Membrane Holders for Dissolution Testing



↑ Watchglass/PTFE Assembly for use with ACI

↑ NGI Dissolution Cup and Membrane Holder

DESCRIPTION

Based on a concept developed by Professor Jason McConville at the College of Pharmacy, University of Texas, USA the **NGI Dissolution Cup and Membrane Holder** incorporates a modification of the standard NGI collection cup. It allows size-fractionated particles from an aerosol cloud to be collected and then tested in a conventional tablet dissolution tester.

The NGI Dissolution Cup only differs from the standard cup in that it has a 50 mm removable insert in the impaction area. Particle sizing is carried out in the conventional manner. Once collection is complete, the insert is carefully removed from the cup, covered with a pre-punched 55 mm diameter polycarbonate membrane and secured in position in a Membrane Holder, using a ring, to form a sealed “disc” or “sandwich”.

The Membrane Holder can now be placed in a conventional Dissolution Tester, such as the Copley DIS 800i, and tested in a manner similar to the “Paddle over Disc” Method described in USP Method 2/5 and Ph.Eur. 2.9.4 using 300 mL of dissolution media and a paddle at 75 rpm rotation speed.

A similar technique can be employed using the Andersen Cascade Impactor, in this case, by applying a 76 mm polycarbonate filter to the collection plates prior to analysis,

such that the drug is captured directly on the membrane, and then sandwiching the inverted membrane between the glass and PTFE surfaces of the **Watchglass/PTFE Assembly** normally used for transdermal patches.

The small amount of aqueous fluid and surfactant found in the lung make it extremely difficult to mimic *in vitro*.

Marques, Loebenberg and Almukainzi list five of the most used simulated lung fluids (SLFs) in Table 11* of their article, “Simulated Biological Fluids with Possible Application in Dissolution Testing”.

The first of these, SLF1, has been used to evaluate different interstitial conditions in the lung following exposure to various environmental emissions.

SLF2 was designed to model the interaction of particles with extracellular lung fluids, in this case, exposure to mercury due to the inhalation of airborne calcines from mine waste.

Another fluid that replicates interstitial fluid, SLF3, was used to evaluate the *in vitro* release of insulin following pulmonary delivery.

In the method described here, Son and McConville suggested the use of two standardised fluids, described in the article under the designation, SLF3 and its modified version, SLF4.

Finally, SLF5 was used to measure the dissolution of titanium tritide particles used as components of neutron generators.

* Margareth R.C. Marques, Raimar Loebenberg and May Almukainzi, *Simulated Biological Fluids with Possible Application in Dissolution Testing. Dissolution Technologies (August 2011) p. 15-23.*

Cat. No. Description

6001	NGI Dissolution Cup and Membrane Holder (each)
6002	55 mm Punch
6003	Watchglass/PTFE Assembly for use with ACI (each)
6004	Pack of 100 Polycarbonate Filters (0.1 micron x 76 mm diameter)
6005	Spare Set of O-Rings

Generic Drug Development

FDA GUIDANCE AND BIOEQUIVALENCE

The FDA has recently issued product-specific guidance for a number of active ingredients including Albuterol (Salbutamol), Budesonide, Ipratropium Bromide and Fluticasone Propionate (FP)/Salmeterol combinations that are used globally for the treatment of asthma and COPD and are consequently routine targets for generic development.

FDA product-specific guidance is designed to streamline the process of demonstrating bioequivalence (BE) for a certain active ingredient - a popular subject of Abbreviated New Drug Applications (ANDAs) - delivered via a specific route.

Levels of generic activity have increased exponentially over the last decade or so. The success of a generic submission relies on the robust demonstration of BE to a reference labelled drug (RLD). This normally involves presentation of *in vitro* data to help demonstrate that the generic will perform in a clinically identical way to the RLD.

Where equipment is specified in the regulatory guidance, it is generally identical to that described in the general chapters of the pharmacopoeias for OIP testing; specifically, the existing dose uniformity sampling apparatus for DDU testing and the Andersen Cascade Impactor (ACI) and Next Generation Impactor (NGI) for APSD measurement.

These test methods have been refined over a number of years such that, in the most part, they represent current agreed best practice for the development of new orally inhaled and nasal drug products (OINDPs).

Notwithstanding, it may be useful to demonstrate BE by showing equivalent results using directly comparable *in vitro* test methods and identical test equipment as originally used to develop the RLD.

However, for many of the popular targets of inhaled drug ANDAs, the original research work may predate generic development by a period of close to 20 years. As a result, the test equipment and methods used in the development of the RLD may differ significantly from those employed today.

This difference in the original type of equipment and method used, in comparison with their current equivalents, can potentially have an effect on the expected results and/



or acceptance criteria used for delivered dose and APSD.

Duplicating the original equipment and test methods as closely as possible eliminates any uncertainty about test results that might result from such sensitivities.

THE PHARMACOPEIA

In recent times, USP has also introduced product-specific monographs for **Fluticasone Propionate** and **Salmeterol**. USP monographs are most commonly used for product release testing, but may also be considered during product development.

These product-specific monographs call for the use of test equipment not hitherto specified in the general USP/Ph.Eur. chapters on OIPs and are based on equipment and methods used in the original development of these products.

Four such monographs for **Fluticasone Propionate (FP)** and **FP/Salmeterol combination** products are already described

in the USP. Two relate to the use of the actives as an aerosol via a Metered Dose Inhaler (MDI). The other two are for actives prepared as inhalation powders for delivery by a Dry Powder Inhaler (DPI). The latter have recently been joined by a fifth monograph relating to **Salmeterol Inhalation Powder**.

A further monograph is currently undergoing in-process revision for **Albuterol Inhalation Aerosol** products.

The monographs concerned cover both delivered dose uniformity (DDU) testing and aerodynamic particle size distribution (APSD).

Delivered dose and APSD are required performance metrics for all OIPs because of their defining influence on the success and consistency of drug delivery.

FLUTICASONE PROPIONATE/SALMETEROL AEROSOLS & POWDERS

The original five monographs specify two different **Glass Sample Collection Apparatuses** for the DDU testing of aerosols and powders respectively.

APSD measurement is conducted using a standard **Andersen Cascade Impactor** equipped with a specially **modified induction port** common to both aerosols and powders and a specially **modified inlet cone and preseparator** for aerosols and powders respectively.

Therefore, items required are:

- Glass Sample Collection Apparatus for the DDU testing of Aerosols
- Glass Sample Collection Apparatus for the DDU testing of Powders
- Modified ACI Induction Port for the APSD of both Aerosols & Powders together with a:
- Modified ACI Inlet Cone for Aerosols
- Modified ACI Preseparator for Powders

The inlet geometry of the modified induction port is similar to that of the Glass Twin Impinger except that it is manufactured from either aluminium or 316 stainless steel.

The similarity in geometry allows for the use of mouthpiece adapters designed for the Glass Twin Impingers. The modified induction port also features a tapered exit with no O-ring, which is why modified versions of the ACI inlet cone and preseparator are required in order for the ACI to accommodate the induction port.

It is important to note that these product-specific monographs do not currently appear in the Ph.Eur.

Indeed, the Ph.Eur. and USP are not fully harmonised with respect to OINDPs in general.

PROCEDURAL COMMENT

According to the monographs, the 28.3 L/min version of the ACI (Stages 0 to 7 plus filter stage) should be used to measure APSD for both aerosol and powder methods despite the fact that the powder method specifies testing at 60 L/min.



This requirement probably derives from the fact that the original method predates the development of the 60 L/min and 90 L/min modified versions of the ACI called for in the general USP chapter.

The inhalation powder monographs require that DDU measurements be conducted for a duration consistent with the withdrawal of 2 litres of air.

This volume is generally considered to be representative of a typical patient with asthma or COPD.

However, for APSD measurements, the duration of the breathing cycle is adjusted to give the volumetric equivalent of 3 litres of air.



Generic Drug Development



This is likely due to the need to achieve adequate volume changes in the ACI.

This sort of accurately-timed flow control can be achieved using the set-ups specified in USP <601> for testing DPIs with a fast acting solenoid valve, such as those typified by the Critical Flow Controllers described on Pages 82 - 85 or the Breath Actuation Controller described on Page 86.

A specially designed **Carrying/Wash Rack** for the FP/Salmeterol ACI is also available.

ANCILLARIES

The following ancillaries are recommended to complete a fully operating test system for the delivered dose testing and APSD measurement of Fluticasone Propionate and FP/Salmeterol Aerosols and Powders:

- Mouthpiece Adapter (see Page 90)
- Andersen Cascade Impactor (see Page 45)
- Vacuum Pump (see Page 91)
- Breath Actuation Controller (see Page 86)
- Flow Meter (see Page 88)

Cat. No. Description

Apparatus for DDU testing of FP/Salmeterol Products

- 8646 Sample Collection Apparatus for FP/Salmeterol Aerosols
- 8640 Sample Collection Apparatus for FP/Salmeterol Powders

Spare Parts for Sample Collection Apparatus for Aerosols

- 8649 Pack of 500 Cotton Wool Balls
- 8647 Separating Flask
- 8648 Flow Meter Adapter
- 8650 Vacuum Pump Adapter

Spare Parts for Sample Collection Apparatus for Powders

- 8641 Pack of 100 Glass Fibre Filters 70 mm
- 8903 Throat
- 8642 Upper Chamber
- 8643 Lower Chamber
- 8610 Stainless Steel Filter Support Disc
- 8645 Clamp Assembly
- 8909 Flow Meter Adapter
- 8910 Vacuum Pump Adapter
- 8644 Spare Set of Glassware (complete)

Apparatus for APSD testing of FP/Salmeterol Products

- 8372 ACI Inlet Cone for FP/Salmeterol Aerosols*
- 8405 ACI Preseparator for FP/Salmeterol Powders*
- 8406 Set of 2 O-rings for FP/Salmeterol ACI Preseparator (Spare)
- 8505 FP/Salmeterol Induction Port*
- 8505SW FP/Salmeterol Induction Port (One-piece 316 Stainless Steel)
- 8506 Flow Meter Adapter for FP/S Induction Port
- 5401A FP/Salmeterol ACI Carrying/Wash Rack

* Please specify **Aluminium (A)** or **316 Stainless Steel (S)** when placing your order.

ALBUTEROL INHALATION AEROSOLS

In January 2018, the USP proposed a new product-specific monograph relating to Albuterol Inhalation Aerosols (Albuterol Inhalation Aerosol In-Process Revision 44(1)).

The monograph concerned covers both Delivered Dose Uniformity (DDU) testing and Aerodynamic Particle Size Distribution (APSD).

DDU and APSD are required performance metrics for all orally inhaled products (OIPs) because of their defining influence on the success and consistency of drug delivery.

EQUIPMENT

The proposed monograph specifies a special **Glass Sample Collection Apparatus** to be used for DDU testing (see above). Testing should be conducted at a flow rate of 12 L/min, with the dose collected on a piece of glass wool.

This apparatus uses a solid plastic mouthpiece adapter (described as a Firing Adapter) having a circular aperture designed to accept an inhaler having a circular mouthpiece of corresponding dimensions.

Note: The critical dimensions of the USP 23 (1995) Induction Port match those of the Albuterol Induction Port and can be substituted as required.

↓ Sample Collection Apparatus for Albuterol Inhalation Aerosols with Firing Adapter



↑ Albuterol Induction Port (with and without sleeve) ↓

← Andersen Cascade Impactor for Albuterol Inhalation Aerosols

Generic Drug Development

ALBUTEROL INHALATION AEROSOLS

As an alternative to the standard Firing Adapter, for those users wishing to accommodate inhalers with different shaped mouthpieces, a silicone rubber Mouthpiece Adapter is also available (see Page 90).

The valve of the inhaler should be primed prior to testing by discharging a predetermined number of actuations to waste, shaking the inhaler between each discharge.

The **DDU** test recommends the collection of 9 samples (each comprising two actuations) throughout the life of 3 individual inhalers, 1 at the beginning, 1 in the middle and 1 at the end.

The inhaler should be shaken prior to each actuation including those shots fired to waste.

The apparatus is rinsed down with diluent at the end of each test into a 50 mL volumetric flask prior to analysis.

As with the DDU apparatus, the apparatus used in the test for **APSD** specifies some special equipment to that described in USP chapter <601>.

APSD measurement is conducted using a standard **Andersen Cascade Impactor** equipped with a specially **modified induction port** (see Page 107).

A special **Inlet Sleeve** is available that slips over the induction port inlet, to enable the induction port to be used with regular mouthpiece adapters used on USP/NGI induction ports.

ANCILLARIES

The following ancillaries are required to complete a fully operating test system for the DDU testing and APSD measurement of albuterol inhalation aerosols:

- Mouthpiece Adapter (see Page 90)
- Andersen Cascade Impactor (see Page 45)
- Vacuum Pump (see Page 91)
- Flow Meter (see Page 88)



↑ Sample Collection Apparatus for Albuterol Inhalation Aerosols with Mouthpiece Adapter

Cat. No. Description

Apparatus for DDU testing Albuterol Aerosol Products

8520	Sample Collection Apparatus for Albuterol Aerosol
8524	Glass Wool (1m length)
8521	Firing Adapter
8522	Flow Meter Adapter

Spare Parts for Sample Collection Apparatus for Albuterol Aerosol

8523	Glassware for Albuterol Aerosol Sample Collection Apparatus
------	---

Apparatus for APSD testing of Albuterol Aerosol Products

8509	Albuterol Induction Port*
8509SW	Albuterol Induction Port (One-piece stainless steel)
8519	Albuterol Induction Port Inlet Sleeve*
8060	Flow Meter to Induction Port/WSC2 Adapter

* Please specify **Aluminium (A)** or **316 Stainless Steel (S)** when placing your order.

Spray Force and Plume Temperature Testing (“Cold Freon[®]”)



1. Set Distance from Impactation Plate



2. Actuate the Device



3. Display Impaction Force

INTRODUCTION

Spray pattern and **plume geometry** are common techniques employed by the pharmaceutical industry to characterise and quantify the shape of the emitted spray from Metered Dose Inhalers (MDIs) and Nasal Sprays.

However, possibly of as much concern as either of these two parameters is the reaction of the user to the impaction force of the MDI or spray on the throat or nasal passages.

The “**cold Freon[®]**” effect (the initial reaction to the cold blast of MDI propellant on the back of the throat) can often result in the patient aborting the inhalation process resulting in inconsistent delivery to the lungs. Similar reactions can be generated by nasal sprays.

The “cold Freon[®]” effect is a function of aerosol spray force and plume temperature.

This effect is widely recognised amongst the inhaler community. Indeed, the “cold Freon[®]” effect is specifically mentioned as one of the criteria required to substantiate therapeutic equivalence in EMA’s “Guideline on the requirements for clinical documentation for orally inhaled products (OIP) including the requirements for demonstration of therapeutic equivalence between two inhaled products for use in the treatment of asthma and chronic obstructive pulmonary disease (COPD) in adults and for use in the treatment of asthma in children and adolescents” published in January 2009.

The sensation is due to the high velocity blast and subsequent evaporation of liquid

propellant remaining in droplets that impact on the back of the user’s throat.

The ability to produce a **softer, warmer aerosol plume** by:

- Changing the formulation (drug, propellant, co-solvent)
- Changing the device (metering volume, actuator orifice diameter)
- Using add-on devices such as spacers or valved holding chambers (VHCs) is important for achieving better patient compliance and more consistent clinical efficacy

Studies into various CFC and HFA based suspensions and solutions, for example, together with different orifice geometries have shown that plume temperature can be widely affected by these parameters.

SPRAY FORCE TESTER SFT 1000

The amount of aerosol deposited on the throat is largely dependent on inertial

impaction i.e. the velocity and APSD of the aerosol cloud concerned.

It follows that since velocity is directly related to impaction force the latter should be a good indicator of local delivery equivalence for an inhaled drug.

The **Spray Force Tester Model SFT 1000** is a high precision instrument for measuring the maximum impaction force of MDIs and nasal sprays over the duration of the spray plume.

It has a range of 0 to 2500 mN and an accuracy of +/- 2.5 mN.

The distance of the device relative to the impaction plate can be adjusted between 0 and 200 mm +/- 0.03 mm using the precision digital gauge.

The device is held in a quick release clamp to ensure rigidity during actuation.

A sample of the inhaler to be tested is required at the time of placing an order so that the special clamp can be made.



↑ Spray Force Tester Model SFT 1000

Spray Force and Plume Temperature Testing (“Cold Freon®”)

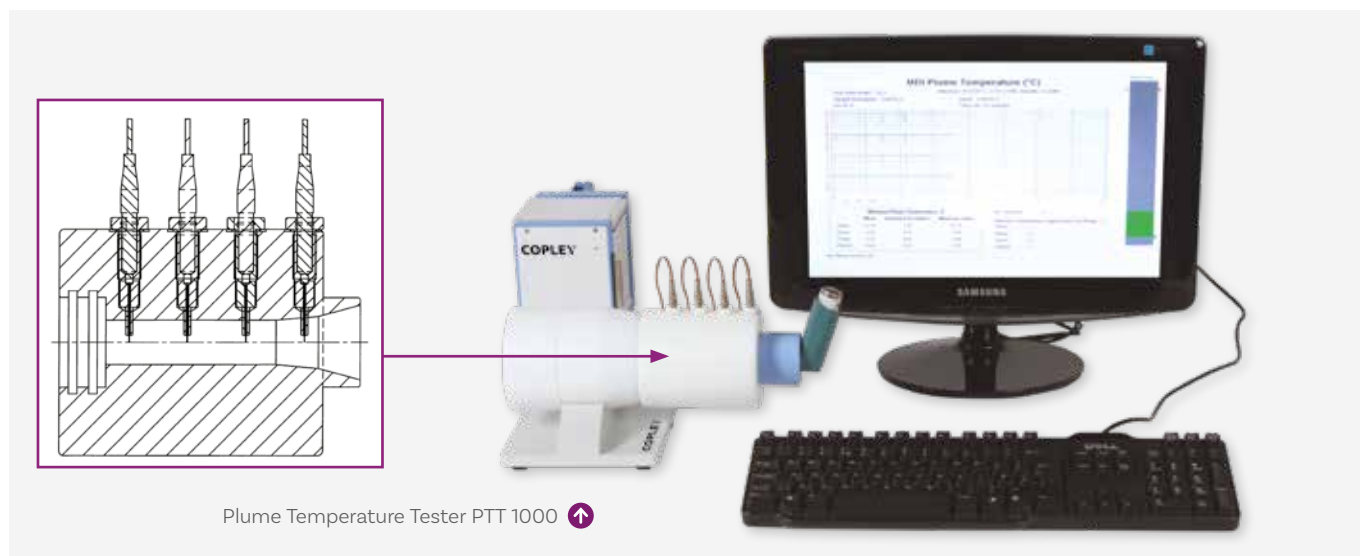

The main features of the SFT 1000 include:

- High sensitivity digital load cell
- Range: 0 to 2500 mN +/- 2.5 mN
- Circular impaction plate - easily removed for cleaning
- High visibility load cell display
- Menu-driven controls
- RS232 output to computer or printer
- Memory capability for up to 100 spray force measurements
- Pass/Fail alarms for user-programmable limits (for QC)
- Precision slides for positioning of inhaler relative to impaction plate
- Quick-release device clamp ensures rigid inhaler support
- Special rubber feet eliminate vibration transmission to load cell
- Battery or Mains powered
- Compact dimensions: 580 mm (l), 200 mm (w), 80 mm (h)
- Supplied complete with calibration certificates for load cell and gauge
- Digital load cell and gauge easily removed for re-calibration
- Load cell calibration verification easily performed by user.

PLUME TEMPERATURE TESTER MODEL PTT 1000

The **Plume Temperature Tester Model PTT 1000** consists of a polypropylene sampling tube, 130 mm long, having the same internal dimensions as the horizontal section of the USP Induction Port.

The temperature profile of the plume is measured by 4 centrally aligned thermocouples mounted vertically at 25 mm, 50 mm, 75 mm and 100 mm from the inlet and linked to a data acquisition system under the control of a PC. The thermocouples are easily removed for cleaning and calibration.

The outside diameter of the inlet of the sampling tube is reduced such that it is the same as the induction port in order to accommodate a similar mouthpiece adapter (and therefore MDI or nasal spray).

The outlet of the PTT 1000 is normally connected to a Waste Shot Collector (see photo on this page and Page 31) and vacuum pump to capture the measured doses at the relevant flow rate.

It can, however, easily be connected directly to a DUSA tube or Ph.Eur./USP Induction Port if preferred, since the outside diameter of all of these three accessories is identical.

Cat. No. Description

Spray Force Tester Model SFT 1000

9000	Spray Force Tester Model SFT 1000
9001	Additional Device Clamp
9002	Re-calibration of Spray Force Load Cell
9003	Re-calibration of Digital Gauge
9004	Spare Impaction Plate
9005	Compact Printer (Force Gauge)
9006	IQ/OQ Documentation for SFT 1000
9007	Qualification Tools for SFT 1000
9008	Re-calibration of SFT 1000 Qualification Tools

Plume Temperature Tester Model PTT 1000

9010	Plume Temperature Tester Model PTT 1000 (incl. Software)
5001	Waste Shot Collector WSC2
5238	Flow Meter DFM 2000 to Induction Port/PTT 1000 Adapter
9011	IQ/OQ Documentation for PTT 1000
9012	Re-calibration of 4 Thermocouples

*Freon® is a registered trademark of The Chemours Company.

Automation

Introduction

The requirements of the regulators responsible for the safety, quality and efficacy of orally inhaled and nasal drug products (OINDPs) place a heavy burden on the companies involved in the development and manufacture of those products in terms of testing.



As far as OINDPs are concerned, the main focus of testing is concentrated on **Delivered (or Emitted) Dose** and **Aerodynamic Particle Size**. The manual performance of both of these tests is labour-intensive, time-consuming and prone to human error.

Fully automated test systems have been developed to address these problems, however they tend to be expensive (>US\$ 1m), complex to operate and resource intensive to develop, validate and maintain.

Semi-automated systems available at a fraction of the cost of their fully-automated counterparts can provide a viable and more economically attractive solution. Semi-automation is normally used to replace repetitive manual operations such as waste firing, cup coating, sample recovery and preparation, etc. Such systems provide robust off-the-shelf solutions at low cost, are normally available on a relatively short delivery time and require little or no validation.

Cascade impaction, for example, is a particularly labour intensive process when performed manually, with a maximum of just five to eight tests per day being typical in terms of output. Recent work suggests that semi-automation significantly improves this throughput with as much as a four-fold increase in productivity.

At the same time, reduced manual handling and operator input gives enhanced reproducibility, eliminating the risk of repetitive strain injury (RSI) and reducing overall cost.

Copley supplies a broad range of **labour saving devices** and **semi-automated systems** supporting both the Andersen Cascade Impactor (ACI) and Next Generation Impactor (NGI).

The NGI Assistant, for example, combined with the Sample Preparation Unit Model SPU 2000 equipped with the NGI Induction Port and Preseparator Fixtures provides a fully integrated system which automates and accelerates the entire sample recovery process reducing work-up times to around 20 - 30 minutes (depending on method).

Labour Saving Tools - Delivered Dose Uniformity



↑ DUSA Shaker for MDIs

DUSA SHAKER

Both the USP and Ph.Eur. state that dose uniformity tests should be carried out on a minimum of 10 doses (from one inhaler in the case of Ph.Eur. and 10 inhalers in the case of USP).

If the inhaler fails to meet the Tier 1 dose uniformity criteria concerned, it may be necessary to repeat the test involving the collection of a further 20 doses.

In addition, in the case of USP, further tests have to be carried out throughout the life of the inhaler i.e. Dose Uniformity through Container Life which involves capturing a further 10 doses from a single inhaler.

All of these tests require the collection and drug recovery of individual doses into the collection tube of a Dosage Unit Sampling Apparatus (DUSA) appropriate to its type (MDI or DPI) prior to assay.

To maximise throughput, most users utilise a number of collection tubes, each sealed with rinsing caps, to collect the required samples.

Once the samples have been collected, solvent is then added to each of the tubes and each tube shaken manually to facilitate drug recovery.

This manual shaking process:

- Is time-consuming

- Can be highly variable (both inter- and intra-analyst) due to inconsistent and incomplete wetting of internal surfaces and
- Can lead to RSI

DESCRIPTION

The DUSA Shaker has been designed to automate the internal rinsing of the DUSA collection tubes to ensure full, fast and repeatable drug delivery from all internal surfaces whilst freeing up analysts to perform other tasks and reducing analyst exposure to RSI.

The DUSA Shaker accepts DUSAs for both MDIs and DPIs.

The **rinsing action** is achieved by a combination of lateral (side-to-side) **shaking** whilst simultaneously **rolling** the sealed collection tubes.

The resultant multi-directional mixing action ensures that all internal surfaces are wetted and that agitation is performed with a consistent, smooth but vigorous action.

The rubber coated rollers are specifically designed to grip the collection tubes during processing whilst reducing noise to a minimum.

This eliminates the necessity to use clamps or other fixtures to hold the tubes in position during mixing and permits tubes to be added or removed at any time.

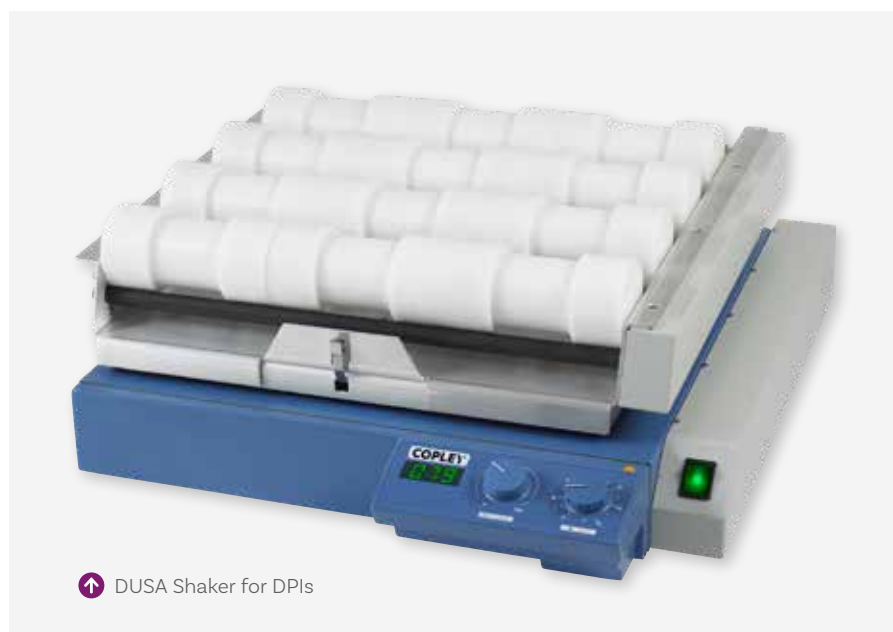

↑ DUSA Shaker for DPIs



← Control Panel

MAIN FEATURES

The DUSA Shaker is designed to accept up to a maximum of **21 MDI Collection Tubes** or **12 DPI Collection Tubes** (or a combination of both).

Partial loads are quite acceptable. The rollers do not have to be fully filled with collection tubes as the rubber coating on the rollers provides sufficient friction to prevent lateral movement of the DUSA tubes during operation.

The lateral (side to side) shake is adjustable between **0 and 200 shakes per minute** via the left-hand knob on the control panel and displayed on the speed indicator.

The duration of the shaking action is controlled via the right hand knob on the control panel. This control allows for either simple on/off control or, if preferred, the setting of a timed period between 0 and 55 minutes.

The controls are such that once the optimum processing conditions have been established that they can be easily replicated.

The rollers rotate at a fixed **speed of 30 rpm** which corresponds to 9.4 rpm for the DUSA for MDIs and 6.5 rpm for the DUSA for DPIs. Control is by an independent on/off switch.

Designed with a small footprint of 570 mm (w) x 610 mm (d), the DUSA Shaker fits comfortably onto a laboratory bench.

Full supporting IQ/OQ documentation is available.

Note: In order to allow rotation, the DUSA Shaker is only compatible with DPI Collection Tubes that have the P1 port blanking plug fitted.

Alternatively DPI Collection Tubes without the P1 port are available as Collection Tube without P1 Port (Cat. No. 8608A).

Spare Rinsing Caps are available with either Silicone Rubber (Cat. No. 8607) or LDPE Seals (Cat. No. 8607A).

See Page 30 for further details.

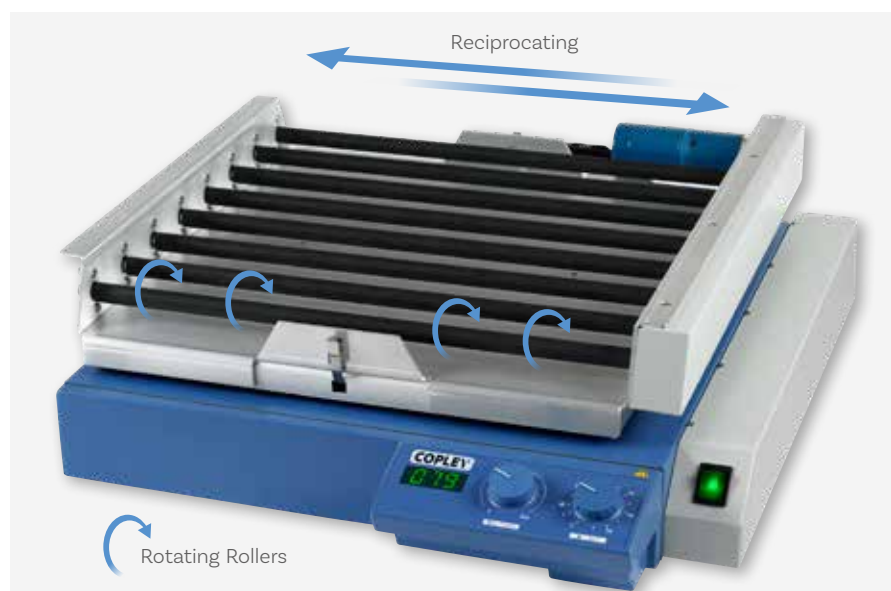

Cat. No.	Description
8620	DUSA Shaker (without collection tubes)
8621	IQ/OQ Documentation for DUSA Shaker
8623	DUSA Shaker Qualification Tools
8624	Re-calibration of DUSA Shaker Qualification Tools
8622	Pack of 10 Plugs (to plug P1 Port on DUSA for DPIs)

Labour Saving Tools - Cup Coating (NGI)



↑ NGI Cup Coater

NGI CUP COATER

Particle bounce and re-entrainment can be a particular problem when using cascade impactors to measure the APSD of OINDPs.

Particle bounce is a phenomenon whereby the particle impacts against the collection surface appropriate to its size but rather than adhering to that surface “bounces” back into the air stream, whereupon it is re-entrained and passes to a lower stage than that intended.

This effect is particularly noticeable when the collection surface is solid, as in the case of the Andersen Cascade Impactor (ACI) and Next Generation Impactor (NGI), and where the particles are hard and dry as in the case of DPIs.

It may also be prevalent in some formulations dispensed by Metered-Dose Inhalers (MDIs) particularly where only a few actuations are delivered to the impactor.

The result is to over-estimate the amount of active available in the form of the Fine Particle Dose (FPD) and hence bias the measured size distribution data to finer sizes.

For this reason, it is important to assess the likely effect of **particle bounce** and subsequent **re-entrainment** of the particles down-stream to lower stages, at an early point in development with a view to taking corrective action.

The normal method of addressing this problem is to coat the collection surfaces with a tacky, viscous material such as, for example, glycerol or silicone oil.

Another solution is to use an impinger, such as the Glass Twin Impinger (GTI) or Multi-Stage Liquid Impinger (MSLI) in which the collection surfaces are liquid, as opposed to an impactor in which the collection surfaces are solid.

If a surface coating is employed, then the amount, its uniformity, the method in which it is applied and its potential to affect the drug recovery process (if applicable) should all be carefully assessed during method development, as these all could impact on the final results.

There is no one solution for all inhaler devices – each drug/device combination must be assessed as a separate entity.

The amount, uniformity and method of application are critical parameters within the coating process.

The **NGI Cup Coater** has been designed as a standardised approach to this problem and eliminates many of the variables inherent in this process.

DESCRIPTION

According to the Pharmacopoeias, “To ensure efficient particle capture, coat the particle collection surface of each stage with glycerol, silicone oil, or other suitable liquid typically deposited from a volatile solvent” unless, in the case of USP, “it has been demonstrated to be unnecessary”.

A wide variety of methods are currently in use for coating impactor collection surfaces to meet this requirement.

The NGI Cup Coater is unique in providing a reproducible method of applying coatings directly to NGI Collection Cups whilst *in situ* in the NGI Collection Cup Tray, thus eliminating the problem of inter-analyst variability.



NGI Cup Coater (Open) →

The micro-processor controlled unit comprises two modules:

- A Coating Station which provides the filling, levelling and drying functions which make up the coating cycle, combined with
- A High Precision Multichannel Dispenser having 8 channels, one for each collection cup

The **Coating Station** consists of a frame specifically designed to accept the NGI Cup Collection Tray containing the cups to be coated.

The frame is fitted with a hinged lid which incorporates the eight precision bore dispense tubes and also the individual fans used to drive off the solvent vapour following dispensation.

The stainless steel dispense tubes are spring-loaded to ensure that they always remain in contact with the cup surface. The tubes are PTFE tipped to avoid scratching and are connected to the dispenser by solvent-resistant tubing.

Operating on the peristaltic pump principle, the **Multichannel Dispenser** has 8 channels, 2 large and 6 small bore relating to the large and small collection cups respectively.

Two graduated solvent reservoirs are available, 500 mL or 1000 mL. Both units are fitted with an airtight 9-way PTFE cap to avoid evaporation.

During normal operation both coater and dispenser are controlled by a single

micro-processor located on the Coating Station frame. The controls comprise a simple illuminated push button switch together with a 3-digit thumbwheel switch to set the drying time.

The Coating Station measures 600 mm x 170 mm x 230 mm and the dispenser 150 mm x 220 mm x 130 mm (w x d x h).

PROCEDURE

The unit is designed to ensure that the number of operations required to carry out a coating cycle is kept to a minimum.

Once the cup tray is loaded, the only action required on the part of the operator is to press the start button on the Coating Station which initiates the following procedure:

1. Dispenser dispenses preset volume of coating media into cups to ensure the base of each cup is covered
2. Coater tilts to allow excess media to drain to rear of cups

3. Dispenser reverses to remove excess media from cup and return it to the solvent reservoir leaving thin film of media on cups*

4. Coater returns to horizontal position, fans activate and drying cycle commences

5. Drying cycle ends and a light on coater illuminates to indicate end of coating cycle

6. The cup tray containing the coated cups can now be removed and replaced with a fresh cup tray

* Saves on solvent and reduces overall drying time

The dispense and reverse cycle times are preprogrammed in the factory and equate to a combined time of 2 minutes. The drying time can be adjusted between 1 and 999 minutes using the 3-digit thumbwheel switch located on the coater front panel.

Cat. No. Description

5900	NGI Cup Coater (excl. NGI Cup Tray & Cups)
5901	500 mL Solvent Reservoir complete with 9-way Cap
5902	1000 mL Solvent Reservoir complete with 9-way Cap
5903	IQ/OQ Documentation for NGI Cup Coater
5904	NGI Cup Coater Qualification Tools
5905	Recalibration of NGI Cup Coater Qualifications Tools

Labour Saving Tools - Sample Preparation (NGI)

↓ Gentle Rocker with Dust Cover (included)



GENTLE ROCKER

One of the main objectives of the NGI Consortium when designing the NGI was that the unit should be easy to use and automate.

Crucial to this objective and one of the unique features of the NGI is the design of the collection cup tray.

During the test, the size-fractionated particles are deposited in a series of eight cups located in a removable cup tray in the base of the impactor.

This allows all eight cups to be removed in a single movement.

It is then a simple matter to insert a new tray containing eight clean cups into the NGI to perform a further test.

Once a test has been performed, the analyst is required to dissolve the active drug present in each sample by adding a small amount of solvent to each cup and then agitating the cup to dissolve the active drug in the cup prior to analysis.

A similar technique must be employed with the mouthpiece adapter, induction port and preseparator (if used).

Whilst the NGI itself has been designed to increase productivity in a standalone form using conventional wash and assay methods, the design has also led to further improvements in productivity through the

use of a number of specially designed labour saving devices.

These sample recovery tools can be divided into manual or semi-automated systems dependent on the degree of automation provided.

A significant number of procedures performed during inhaler testing are highly repetitive and their performance can lead to bottlenecks which compromise overall laboratory operations and efficiency.

Relatively simple and inexpensive sample recovery tools have been designed to alleviate such problems and to ensure testing is carried out in a consistent, reproducible and controlled fashion.

DESCRIPTION

The **Gentle Rocker**, for example, is a simple, economical device for gently agitating the contents of the NGI Collection Cups in order to dissolve the active drug in the solvent prior to analysis.



↑ Storage Cabinet for 6 NGI Cup Trays without Cup Trays

The unit comprises a pivoting platform specifically designed to accept the NGI Collection Cup Tray linked to a synchronous motor drive unit (20 or 40 rpm models) and controller.

A dust cover is provided as standard to protect the samples during processing. Additional covers can be provided on request.

In operation, the Gentle Rocker rocks back and forth about a central longitudinal axis.

The resulting constant motion helps to dissolve the drug in a controlled manner freeing up analyst time for other tasks.

Approximately 10-15 mL of solvent in the small cups and 20-25 mL in the large cups is normally sufficient to provide good coverage of the cup surface whilst avoiding spills during operation.

The run time (default 10 minutes) can be set by the user, dependent on the nature of the dissolution.

The Gentle Rocker measures 70 x 18 x 16 cm (w x d x h).

ACCESSORIES

A number of accessories are available for the Gentle Rocker primarily designed to safeguard the integrity of the samples concerned and maintain the condition of the collection cups which are performance critical and particularly prone to damage.

In addition to the dust covers, evaporation eliminating covers fitted with seals and retaining clips are also now available in order to minimise any solvent loss during operation where evaporation is a particular problem.

Also newly available, is a special storage cabinet designed to accept six NGI Cup Collection Trays and their associated cups.

Note: The collection cup is a critical part of the NGI as it governs the “jet to plate” distance on which the APSD measurement is based.



↓ Storage Cabinet for 6 NGI Cup Trays with Cup Trays and Collection Cups present

↑ Collection Trays fitted with a Dust Cover (top) and an Evaporation Cover (bottom)

Cat. No. Description

5220	Gentle Rocker (complete with dust cover and 20 rpm motor)
5221	Gentle Rocker (complete with dust cover and 40 rpm motor)
5223	Evaporation Cover (with seals and clips to prevent solvent loss)
5255	Dust Cover (Spare)
5224	Storage Cabinet for 6 NGI cup trays (not included)
5225	IQ/OQ Documentation for Gentle Rocker
5235	Verification of Gentle Rocker
5256	Gentle Rocker Qualification Tools
5257	Re-calibration of Gentle Rocker Qualification Tools

Labour Saving Tools - Sample Preparation (ACI & NGI)



↑ Gentle Rocker (see Page 118) alongside Sample Preparation Unit SPU 2000, equipped with NGI Preseparator Fixture and Induction Port Fixture

SAMPLE PREPARATION UNIT MODEL SPU 2000

A significant number of the procedures performed during inhaler testing are highly repetitive but not technically complex and do not necessarily justify full automation.

Relatively simple and inexpensive sample preparation tools can help reduce the unwanted effects of repetitive strain injury (RSI), alleviate bottlenecks and ensure that testing is carried out in a consistent, reproducible and controlled manner.

DESCRIPTION

The **Sample Preparation Unit Model SPU 2000** is designed to provide an inexpensive means of recovering active drug from the induction ports employed on the ACI, the NGI and the special induction port used in the testing of albuterol and FP/Salmeterol formulations together with the preseparator of the NGI.

The fixtures feature custom made brackets and use simple silicone rubber end caps to secure and seal the equipment during operation.

The SPU 2000 is designed to accept two fixtures at any one time.

The unit works particularly efficiently when fitted with the NGI Induction Port and NGI Preseparator Fixtures and then combined with the Gentle Rocker (see photograph above) to provide a complete NGI sample preparation system.

On initialisation, the SPU 2000 automatically adjusts the orientation of the two fixtures to the loading position prior to starting the rinsing process.

The SPU 2000 has variable speed control between 20 and 60 rpm (+/- 1 rpm). This allows the user to adjust the mixing intensity and consequently the dissolution conditions applicable to that particular formulation.



↑ Fixture with ACI/Albuterol Induction Port



↑ Fixture with NGI Induction Port



↑ Fixture with FP Induction Port



↑ Sample Preparation Unit Model SPU 2000 equipped with NGI Preseparator Fixture and NGI Induction Port Fixture ↑

Similarly, the duration of the rinsing cycle can be selected in either revolutions of the fixture (0-9999) or time in hours, minutes and seconds (up to 8 hours).

Control of the unit is provided by a membrane keypad linked to a 4-line 20 character back-lit LCD screen.

During processing, both the nominal duration and remaining duration to the end of the cycle are displayed on screen in terms of either rpm, or time together with the selected speed.

The SPU 2000 measures 33 x 33 x 32 cm (w x d x h) when equipped with a single Induction Port Fixture and 65 x 31 x 35 cm (w x d x h) when equipped with a single preseparator fixture.



↑ SPU 2000 with 2 NGI Preseparator Fixtures



Cat. No. Description

9202	Sample Preparation Unit Model SPU 2000 (without Fixtures)
9216	Fixture for ACI/NGI/Albuterol & FP Induction Port (each)
8503	Set of 2 Silicone Rubber Rinsing Caps for FP Induction Port
8504	Set of 2 Silicone Rubber Rinsing Caps for ACI/Albuterol Induction Port
5265	Set of 2 Silicone Rubber Rinsing Caps for NGI Induction Port
9217	Fixture for NGI Preseparator (each)
5266	Set of 2 Silicone Rubber Rinsing Caps for NGI Preseparator
9212	IQ/OQ Documentation for SPU 2000
9213	SPU 2000 Qualification Tools
9214	Re-calibration of SPU 2000 Qualification Tools

Labour Saving Tools - Impactor Cleaning (ACI & NGI)



↑ ACI Carrying Rack in Ultrasonic Cleaning Bath



↑ ACI Carrying Rack in Rinse Bath



↑ ACI Carrying Rack in Drying Oven

IMPACTOR CLEANING SYSTEM

Cascade impactors are precision instruments and should be treated with care. Regular cleaning and drying is an essential element of good impactor practice and ensures that the instrument is free of debris prior to testing and that the unit remains in optimum condition throughout its life.

The importance of proper, consistent, reproducible and controlled cleaning and drying procedures should not be overlooked. The **Impactor Cleaning System** has been specifically designed to clean component parts of both the ACI and NGI.

One of the most common methods of cleaning impactors is through the use of an ultrasonic bath.

This involves immersing the various impactor parts in an ultrasonic bath containing clean water to which has been added a small amount of cleaning agent and which has then been pre-heated to approximately 50 degrees C.

Decon Neutracon (www.decon.co.uk) is a near neutral (pH 7) concentrate specifically designed for use on materials which have been "corroded, etched, discoloured or

weakened by acidic or alkaline agents" and is ideally suited for this purpose.

The impactor parts are normally placed in a rack prior to immersion (a) to segregate them during the cleaning process and (b) to maximise the surface area exposed to the cleaning process.

Processing times vary depending on the materials of construction employed in the impactor, e.g. aluminium, stainless steel, titanium, and the degree of soiling but are typically between 2 and 15 minutes.

Ultrasonic baths use ultrasound (usually from 15-400 kHz) to penetrate holes and other difficult-to-access places, and to remove sticky, adhering or embedded particles from solid surfaces.

Following cleaning, the parts are normally rinsed in clean cold water and then placed in a heated cabinet at approximately 35 to 40 degrees C for about 30 minutes to dry.

A key feature of the Impactor Cleaning System are the purpose designed racks which accept the various parts of the impactor being cleaned.

DESCRIPTION

The **Impactor Carrying/Wash Racks** are constructed from heavy duty polypropylene and fitted with neoprene cushions to prevent scratching to the outer surfaces of the parts.

The **ACI Rack** has 21 apertures corresponding to the 8 stages, the 8 collection plates, the inlet cone, induction port and the 2 parts of the preseparator of the ACI. A **modified FP/Salmeterol ACI Rack** is also available to accommodate the special induction port and preseparator used.

These not only act as a carrying rack but also as a handy storage facility for individual ACIs whilst not in use, thus assuring the correct stage order and preventing mix-ups with the corresponding parts on other impactors.

The **NGI Rack** has 12 apertures corresponding to the 8 cups, induction port and the 3 parts of the NGI preseparator.

Each rack measures 420 mm (w) x 230 mm (d) and is designed to fit inside the basket used in the Ultrasonic Cleaning Bath. The basket prevents the carrying rack from touching the bottom or sides of the bath.

↓ ACI Carrying Rack draining on the Rinse Bath





↑ Impactor Cleaning System

The **Impactor Ultrasonic Cleaning Bath** has a temperature range of ambient + 5 to 69 degrees C in 1 degree C increments.

It measures 540 mm (w) x 340 mm (d) x 290 mm (h) and has a capacity of 22 litres.

Main features of the bath include:

- Illuminated mains power, heater, timer and alarm indications
- Digital temperature control
- Electronic variable run back 0 - 30 minute timer
- Audible buzzer ends timed period
- Clearly visible LED display
- Time/temperature display
- Menu-driven data entry
- Low liquid level audible alarm
- Constant tuning ultrasonics (eliminates need for frequency sweeping)
- Crevice-free, corrosion-resistant stainless steel bath
- Heating element, safety cut-out, liquid level and temperature sensors as standard

The **Impactor Rinse Bath** comprises two parts, the bath and the drain rack used to rinse (in cold water) and drain the impactor parts following sonication. Specifically designed to accept the carrying racks, the bath measures 520 mm (w) x 610 mm (d).

The **Impactor Suction Aspirator** (see photo on left) is used to remove the small amounts of excess water that collect in the bottom of the impactor stages and preseparator parts following rinsing and prior to drying. It comprises a hand-held probe linked via a water collection jar to a vacuum pump, which provides the necessary suction.

ACI Carrying/Wash Rack →



NGI Carrying/Wash Rack ↑



The **Impactor Drying Oven** is a forced air circulation unit having a capacity of 133 litres and a temperature range of 25 - 70 +/- 1 degrees C. It is designed to accept 3 individual carrying racks.

The unit is fitted with an inner glass inspection door together with a wipe-clean, all stainless steel interior. Internal and external dimensions are 515 mm (w) x 430 mm (d) x 600 mm (h) mm and 705 mm (w) x 625 mm (d) x 820 mm (h) mm respectively.

All controls are located on a single panel. The in-built microprocessor controls all the various functions including adjustable alarm limits, acoustic alarm, data logging, timer, fan, speed and PID control of temperature via a LED display. The respective parameters

are entered by means of a touch-sensitive button linked to a LED display which is also used to display the temperature, time and fan speed.

The unit is provided with timed operation as standard (0-999 minutes or 0-999 hours). The timer is programmed such that the timed period commences only when operating temperature has been reached.

The 4-speed forced air circulation means that the oven reacts rapidly to change and is ideally suited to impactor drying, where maximum accuracy and warm-up are required and the door is to be opened on a frequent basis.

The Impactor Cleaning System requires a bench space of 1.8 metres.

Cat. No. Description

5400	Impactor Cleaning System (excluding Carrying/Wash Rack)
5401	ACI Carrying/Wash Rack
5401A	FP/Salmeterol ACI Carrying/Wash Rack
5205	NGI Carrying/Wash Rack

Modules Only

5402	Impactor Ultrasonic Cleaning Bath (including basket and lid)
5403	Impactor Rinse Bath
5404	Impactor Suction Aspirator
5405	Impactor Drying Oven
5406	Stainless Steel Drip Tray

Semi-Automation - Automated Shake, Fire and Flow Control for MDIs



← Vertus II with ACI

VERTUS II

Central to the successful operation of an MDI is complete filling of the chamber of the metering valve. Actuation connects this chamber to the atmosphere, triggering propellant-driven expansion and delivery of the metered dose. This mechanism makes MDIs susceptible to variability associated with device firing. For suspension MDI formulations there is also potential for variability as a result of settling or creaming.

Parameters associated with firing of an MDI can therefore directly influence characteristics of the delivered dose. Such parameters include:

- The speed, angle and duration of shaking, ahead of actuation
- Firing force, and the speed of application and release of that force
- Any time delay between the end of shaking and device actuation

This potential for variability is reflected in FDA draft guidance which includes Specific Characterization Studies relating to the systematic investigation of, for example, the effect of Priming and Repriming (repeat firing of the device ahead of measurement/use) and Effect of Storage and Shaking (suspension formulated MDIs only).

Automated shake and fire systems enhance the sensitivity of such testing and, more broadly, boost the integrity of MDI data by eliminating firing errors and reducing variability. They enable precise, controlled, reproducible testing while at the same time boosting productivity and cutting the risk of RSI.

DESCRIPTION

Vertus II is a fully automated shake and fire bench top system for precision-controlled, highly repeatable MDI testing. Compatible with most inhalers and a wide range of dose collection devices, it allows complete control over the test technique, offering the flexibility to apply any industry standard test method; method transfer is straightforward and robust. By simplifying and automating labour-intensive aspects of MDI testing, Vertus II reduces training requirements at the same time freeing up analysts for other tasks. It allows the precise replication of test methods, from operator-to-operator, and at different sites.

During testing, inhalers are clipped securely into the Vertus II using unique holders customised to fit specific devices. Collection devices are mounted on interchangeable interface plates, making switching quick and easy. Test parameters are controlled via an

easy-to-use touch screen and include:

- Shaking profile
- Angle of fire
- The duration of any time delay between shaking and firing
- The resting position of the inhaler

Flow control is integral to the system and all test parameters are automatically recorded.

Vertus II delivers high productivity, walkaway MDI testing, particularly when used in combination with a DUSA stack incorporating up to four DUSA tubes and a waste shot collector. In this set-up, Vertus II automatically switches air flow between the devices in accordance with a defined test method. Doses can be collected at the start, middle and end of product life, and fired to waste, as required for Dose Content Uniformity testing, all without manual intervention. Thousands of shots can be trapped safely and efficiently over the course of a complete experiment.

MAIN FEATURES

Vertus II is suitable for all MDI testing requirements, both DDU and APSD measurement, and is compatible with all standard dose collection devices including the NGI, ACI, DUSA and waste shot collectors. It can be used with all MDI designs with no need to remove the cannister from the inhaler prior to test.

Alignment of the inhaler mouthpiece and collection device inlet port is a method setting within Vertus II, eliminating any requirement for manual adjustment. Silicone mouthpiece adapters ensure a good inhaler/collection device seal and leak testing is automatic, saving time and reducing scope for error.

Flow rate through the collection device is automatically controlled, at the required set point, to within +/- 1 L/min, upto a maximum of 30 or 60 L/min depending on the device. Air flow is generated from a local pressurised air supply with no requirement for a dedicated pump or flow meter, or for any manual connection or intervention. Flow duration can also be set to control inspiration volume (e.g. 2L).

Closed loop control delivers a precision shaking action with the flexibility to configure:

- Starting angle -360° to + 360°
- Angle of rotation -720° to +720°
- Frequency, to a maximum of 3.1 Hz @ 180° angle of rotation
- Duration, from 0 - 120s

Device firing is performed by an air cylinder and can be configured to apply up to three distinct forces per actuation in classic firing mode. This facility is typically used to set forces that detect, insert and fire the cannister. A more complex profile (up to 10 forces and durations) can be applied to closely replicate manual firing in profile firing mode. Force rise time, fire down time, and force release time can all be independently set, from 0 - 5000 ms; the maximum applied force is 95 N.

To further boost testing efficiency Vertus II can be configured to handle 'supermethods' involving firing to multiple collection devices, for example using a DUSA stack. Where such

methods involve a manual collection device change, the analyst simply needs to press 'continue' once this is complete.

All test methods are programmed, approved, saved and recalled as required using an intuitive touchscreen display. Key parameters (including temperature and relative humidity) and results from each test can be stored locally, to a USB device or to a Local Area Network (LAN); the system also has a Laboratory Information Management System link. Electronic Records/Electronic Signatures functionality provides a basis for obtaining ER/ES regulatory approval compliant with 21 CFR Part 11.



In April 2019, Copley acquired Novi Systems Ltd. The addition of the innovative shake, fire and flow control products for delivered dose uniformity and cascade impactor testing of MDIs, BAIs and nasal sprays, ensures our customers continue to have access to the most comprehensive range of inhaler testing solutions available.

Cat. No./Description

9701	Vertus II Shake and Fire System
9702	Temperature and Humidity Sensor
9703	LAN Data Storage for ER/ES Compliance
9704	Direct Thermal Printer for Vertus/DecaVertus
9716	Direct Thermal Printer Labels (12 Rolls of 475 each)
9718	Thermal Transfer Printer for Vertus/DecaVertus
9719	Thermal Transfer Printer Labels (12 Rolls of 475 each)
9725	Thermal Transfer Printer Ribbon (6 Cartridges)

Accessories

9705	MDI Holder (per inhaler design)
9606	ACI Interface Plate
9706	ACI Interface Plate with Induction Port Support
9707	NGI Interface Plate
9708	NGI Interface Plate with Waste Shot Collector
9715	GTI Interface Plate
9709	DUSA Interface Plate
9710	DUSA (x4) Interface Plate with Waste Shot Collector
9711	Waste Shot Collector with Interface Plate
9901	Mouthpiece Adapter Mould (per inhaler/inlet design)
9902	Mouthpiece Adapter for ACI/NGI Induction Port and DUSA
9903	Mouthpiece Adapter for Other Inlets (each)
9713	Fire Force Calibration Load Cell with Holder
9714	Compressor

Spare Parts

9712	Spare Filter Cartridge for Waste Shot Collector
9716	Printer Labels (12 rolls of 475 each)

Semi-Automation - Automated Shake, Fire and Flow Control for MDIs

VERTUS PLUS

Shot weight, the weight of the dose released during a single actuation of an MDI, is routinely recorded as part of a DDU or APSD measurement method and provides a useful check on the consistency of drug release from the inhaler. The routine measurement of shot weight is therefore an efficient way to detect misfiring and, more broadly, can be helpful for analytical troubleshooting. Automation significantly streamlines the testing process when shot weight information is required.

DESCRIPTION

Vertus Plus is a fully automated bench top shake and fire system with integral shot weight measurement for MDI testing. It offers all the functionality of the Vertus II but in addition has an integrated weighing balance, which automatically records the mass of the inhaler at any point during a method. With Vertus Plus even complex methods requiring shot weight collection can be fully automated, to the point of push button, walkaway operation, freeing analysts for more productive tasks while at the same time improving data integrity.

MAIN FEATURES

The main features of Vertus Plus are identical to those of the Vertus II with the additional feature of an integrated 5 decimal place Mettler Toledo balance for automatic shot weight measurement. Shot weights are reported along with all other test information.

Combining the Vertus Plus with a DUSA stack, consisting of 4 DUSAs and an integrated waste shot collector, results in a high throughput set-up for fully unattended DCU testing complete with automatic shot weights recording. This is a highly efficient, high productivity solution for information-rich DDU testing.

Vertus Plus measures 921 x 490 x 758 mm (w x d x h).



Vertus Plus with DUSA stack, balance display and printer

Cat. No./Description

9720	Vertus Plus Shake and Fire System
9702	Temperature and Humidity Sensor
9703	LAN Data Storage for ER/ES Compliance
9704	Direct Thermal Printer for Vertus/DecaVertus
9716	Direct Thermal Printer Labels (12 Rolls of 475 each)
9718	Thermal Transfer Printer for Vertus/DecaVertus
9719	Thermal Transfer Printer Labels (12 Rolls of 475 each)
9725	Thermal Transfer Printer Ribbon (6 Cartridges)

Accessories

9705	MDI Holder (per inhaler design)
9606	ACI Interface Plate
9706	ACI Interface Plate with Induction Port Support
9707	NGI Interface Plate
9708	NGI Interface Plate with Waste Shot Collector
9715	GTI Interface Plate
9709	DUSA Interface Plate
9710	DUSA (x4) Interface Plate with Waste Shot Collector
9711	Waste Shot Collector with Interface Plate
9901	Mouthpiece Adapter Mould (per inhaler/inlet design)
9902	Mouthpiece Adapter for ACI/NGI Induction Port and DUSA
9903	Mouthpiece Adapter for Other Inlets (each)
9713	Fire Force Calibration Load Cell with Holder
9714	Compressor

Spare Parts

9712	Spare Filter Cartridge for Waste Shot Collector
9716	Printer Labels (12 rolls of 475 each)

Nasal spray dose
collection module →



AUTOMATED NASAL SPRAY TESTING SYSTEM

As with MDIs, the manual firing of nasal sprays utilising metered spray pump or propellant-based aerosol technology can introduce variability in drug delivery. The nasal spray testing module for the Vertus II automates the shaking and firing of nasal sprays eliminating this issue. Developed in direct response to customer requests, to ease compliance with EMA and FDA requirements for nasal products, it is a space and time-efficient device that enables the full control of firing force with no requirement for additional equipment. Products can be fired both to dose collection and to waste (the module includes a removable waste reservoir for waste dose collection) with the option to collect individual doses for assay. Key features for nasal testing include the ability to:

- Measure the distance of travel of the spray during firing
- Control pauses between firing
- Calculate shot weights for direct comparison with label claim

For ordering information, please contact our Sales Team.



↑ Vertus Plus with nasal spray waste dose collection module

Semi-Automation - Automated Shake, Fire and Flow Control for MDIs

DECAVERTUS II

Dose Content Uniformity testing for MDIs requires sampling throughout the life of the product and the associated firing to waste of intermediate shots. The regulatory expectation is that firing to waste is carried out under representative conditions, a repetitive, labour-intensive process.

For example, the USP specifies the testing of ten inhalers for DDU (for testing over the entire unit life), with the collection of two samples, one at the beginning and one at the end of product life. In the case of a 100 dose inhaler this could mean firing 98 shots to waste, for each of ten inhalers, to complete the test. Automating this process is highly advantageous from the perspective of conserving analyst time, eliminating the risk of RSI, and maximising the repeatability of test data; firing to waste under well-defined, closely controlled conditions eliminates a potential source of variability in testing.

DESCRIPTION

DecaVertus II is a state-of-the-art, fully automated, high throughput 10-way shake and fire to waste system for MDI testing. Designed to accommodate the entire inhaler, as used by a patient (in-actuator), it is equally suitable for traditional canister-only wasting. DecaVertus is a standalone system based on proven Vertus II technology and offers the same flexibility for complete control of a wide range of test parameters including: shaking profile, angle of fire, the duration of any time delay between shaking and firing and the resting position of the inhaler.

Up to 10 inhalers are easily loaded into the carriage of the DecaVertus which is then clipped securely onto the shaking platform. An innovative design channels each inhaler to a dedicated waste shot collector (HEPA



↑ DecaVertus



↑ Placing MDIs into carriage

filter), maximising the airflow through each individual device. This ensures efficient dose capture and removal, reducing waste channel clogging to a minimum. In practical terms, this means less cleaning, improved health and safety and allows lengthy test methods to be run without interruption.

The intuitive touchscreen of the DecaVertus makes it straightforward to define appropriate shaking, firing and airflow parameters for firing to waste, and to reliably

apply defined methods with minimal manual intervention. Methods can be precisely replicated by different operators, and across multiple sites. Since DecaVertus is fully compatible with Vertus II, methods can also be easily transferred between systems as the product proceeds to commercialisation, with DecaVertus often used in production to alleviate the increased burden of through-life testing.



↑ Waste shot collector array



↑ Inserting carriage into DecaVertus II

MAIN FEATURES

DecaVertus II handles upto 10 inhalers simultaneously, canister alone or in-actuator, and is compatible with most MDIs. It can be operated partially full (< 10 inhalers) and switching between canister-only and in-actuator operation is quick and easy.

Air flow rate through the inhalers is generated using a local pressurised air supply with no requirement for a dedicated external pump or flow meter. Flow rate is automatically controlled to a user defined set point within the range 10 – 85 L/min per channel. Air flow turns on automatically as required to minimise energy consumption.

Each inhaler is tested within an identical environment; each has dedicated air flow control, dedicated firing mechanism and a separate waste channel. This design significantly reduces the risk of incorrect firing force or air flow, at the same time minimising cleaning requirements and the likelihood of channel blockage.

Multiple parameters can be varied to apply a precisely defined shaking action including:

- Starting angle 0 to 360°
- Angle of rotation 0 to 720°
- Frequency, to a maximum of 2.6 @ 180°
- Shaking duration and pause after duration, both 0 – 9999s
- The angle at which the device is held between firing cycles, in the range 0 – 360°

Device firing is performed by an air cylinder and can be configured to apply up to three distinct forces per actuation. This facility is typically used to set forces that detect, insert and fire the cannister. Firing conditions are precisely controlled by varying the parameters: fire rise time, fire down time, and force release time, all within the range 0 – 65000 ms; and insert and fire force, both within the range 0 – 100 N.

All test methods are programmed, approved, saved and recalled as required using a modern intuitive touchscreen interface.

Key parameters (including temperature and relative humidity) and results from each test are stored locally as a binary file. These can then be transferred to a USB device or to a Local Area Network (LAN).

DecaVertus II measures 1011 x 593 x 369 mm (w x d x h) and is supplied with 10 waste shot collector filters as standard.

Cat. No./Description

DecaVertus Waste Shot Collection for MDIs

9801	DecaVertus II Shake and Fire to Waste System
9802	Temperature and Humidity Sensor
9803	LAN Data Storage for ER/ES Compliance
9804	DecaVision Module and Software
9704	Direct Thermal Printer for Vertus/DecaVertus
9716	Direct Thermal Printer Labels (12 Rolls of 475 each)
9718	Thermal Transfer Printer for Vertus/DecaVertus
9719	Thermal Transfer Printer Labels (12 Rolls of 475 each)
9725	Thermal Transfer Printer Ribbon (6 Cartridges)

Accessories (MDIs only)

9805	Carriage for MDI (per inhaler design)
9806	Carriage for MDI Cannister Only (per cannister size)
9808	Carriage for MDI Canister Only (any size)
9807	Fire Force Calibration Load Cell with Dummy Cannister
9714	Compressor

Spare Parts

9716	Printer Labels (12 rolls of 475 each)
9820	Pack of 10 Spare Waste Filter Cartridges
9821	Pack of 300 O-rings

IQ/OQ, Maintenance and Support: Vertus II/Plus and DecaVertus II

Cat. No./Description

IQ/OQ and Maintenance

9730	Vertus/DecaVertus Qualification Kit
9728	IQ/OQ Documentation for Vertus II/Vertus Plus
9810	IQ/OQ Documentation for DecaVertus

Support

1006	Remote Access Support for Vertus/DecaVertus (1yr/10hrs)
9721	Remote Diagnostic Gateway (Modem)
9724	Direct Connection Setup – Remote Support

Semi-Automation - Next Generation Impactor (NGI)

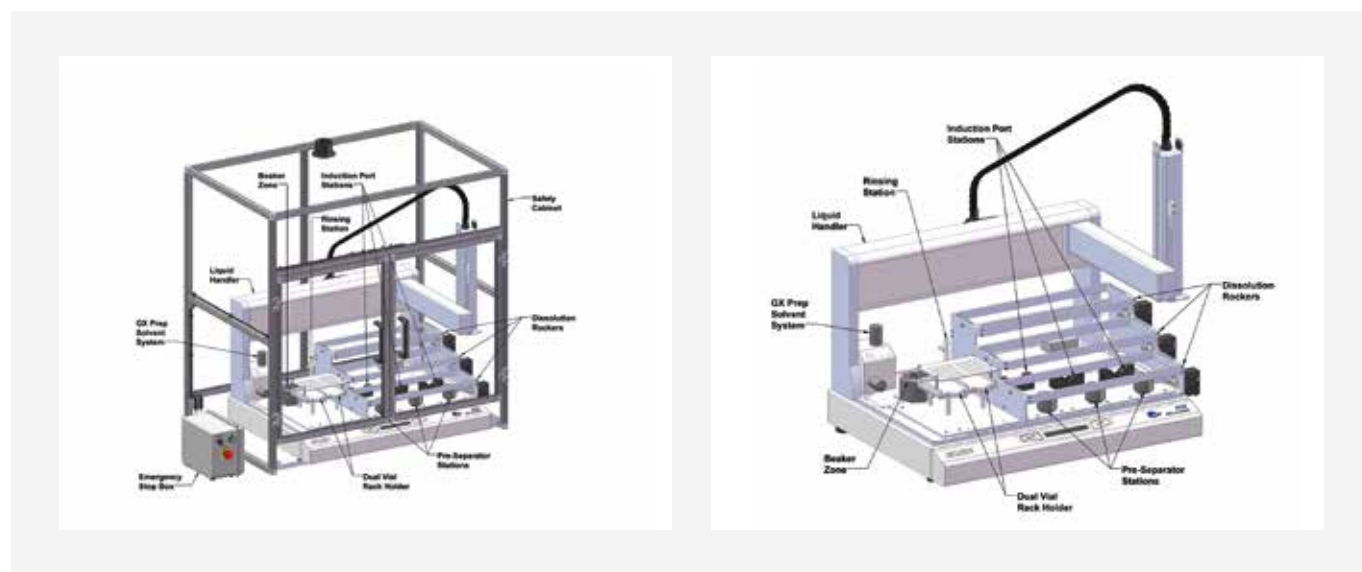

NGI ASSISTANT

Of the preferred cascade impactors used to measure the aerodynamic particle size distribution of inhalers, the Next Generation Impactor (NGI) is one of the most common.

The manual recovery of samples from such impactors can be tedious, time-consuming and prone to human error.

Systems that help to automate the sample recovery process can therefore be a valuable asset to the pharmaceutical laboratory.

The **NGI Assistant** is a semi-automation system that places a known quantity of solvent in each cup of three NGI collection cup trays, gently agitates the contents in order to dissolve the active drug in the solvent and then places a representative sample of solution from each of the cups into HPLC vials for subsequent analysis.

The system has been specifically designed to provide an accurate, reproducible and efficient means of recovering samples from the NGI following testing, thereby increasing throughput and reducing analyst-related variability.

In practice, the operator places up to 3 NGI cup collection trays on the location lugs of the three platforms provided for this purpose and adds a dust cover (or an optional sealed evaporation cover - (see Page 119) to prevent solvent loss.

An x-y-z robotic pipette is then used to add a precise volume of solvent to each collection cup whereupon the rocking motion starts to dissolve the active drug in the solvent.

After dissolution, the robot then aspirates an aliquot of each of the dissolved samples into HPLC vials for further analysis. An air gap is introduced between each sample to avoid cross contamination.

Software controlled, the system allows pre-defined methods to be saved and recalled as necessary.

It takes **approx. 30 minutes to process 3 trays**, depending on method.

By removing two of the three cup trays, the NGI Assistant can also be used to dispense known quantities of solvent into three induction ports and/or pre-separators prior to rinsing.

The unit comes as standard with two Waters 8 x 6 vial racks designed to accept 2 mL HPLC glass vials. The glass vials can be either capped (with a pre-slit PTFE/Silicone septa) or uncapped.

Alternatively, the system can be configured to accept two Agilent 9 x 6 vial racks.

A safety enclosure together with emergency stop button and provision for extraction facilities is supplied as standard.

The NGI Assistant comes complete with all the necessary documentation for the setup and operation of the system together with a Factory Acceptance Test Certificate (FAT) and IQ/OQ documentation to cover the installation of the equipment concerned.



↑ NGI Assistant with Safety Enclosure



← NGI Assistant without Safety Enclosure

APPLICATION

The most cost effective method of deploying the NGI Assistant is to use the unit in conjunction with one NGI, three NGI cup trays, 3 induction ports, 3 preseparators (if required), an NGI Induction Port Rinser and an NGI Preseparator Rinser (see next page) to provide a complete test and sampling facility for three complete analyses.

The key to the NGI Assistant's operation lies in the GX Prep Solvent System and the 6-position rotary selection valve. This allows the needle used on the x-y-z pipette to be connected to six different channels. Positions 1 and 6 are allocated to "waste" and "air intake", which leaves the other four channels available for drug recovery solvents and/or internal standards or buffers.

LED indicators on the valve front panel indicate which port is currently connected to the needle.

A bi-directional pump built into the solvent system operates in conjunction with the valve to provide the following functions required for liquid handling:

- Dispense solvent and/or standards
- Aspirate samples from the NGI cups
- Dispense the samples to the vials
- Aspirate and dispense, for example, a buffer to the vials from the beaker

The whole system is controlled by means of a separate PC. The easy to use Windows-based software provides four default routines including pump conditioning, system priming,

calibration and system validation as well as one customer specific application configured to your particular recovery method.

Additional methods can be generated, or existing ones modified, by the user.

A typical operational sequence is described below. The sequence assumes that the reservoirs/beakers containing the requisite solvents, standards, buffers and stabilisers are in position, that the vial racks have been loaded with vials and that the system has been primed and calibrated ready for use.

OPERATION

Place the three induction ports and preseparators (suitably capped at one end) in their respective locations, load the default application programme into the Sample List toolbar and press "Run".

The valve now sequences to the designated solvent reservoir and the induction ports/preseparators are filled with the appropriate amounts of solvent.

The system now pauses whilst the induction ports and preseparators are removed for processing (see the rinsers described overleaf) and are replaced by three collection cup trays.

The user then resumes the operation by clicking "OK" whereupon a precise volume of solvent is added to the 24 collection cups. The collection trays then start to rock to dissolve the active drug in the cups prior to analysis.

Once the recovery process is complete, the bi-directional pump reverses so as to allow an aliquot to be extracted from each cup and injected into a vial located in a storage rack which can then be subsequently removed for analysis.

The NGI Assistant measures 117 x 72 x 97 cm (w x d x h).

Cat. No. Description

5415	NGI Assistant (3-Tray) complete with Safety Enclosure
5223	Evaporation Cover (with seals and clips to prevent solvent loss)*
5255	Dust Cover (Spare)*

* **Note: 3 required for NGI Assistant**

Qualification

Introduction

Good Manufacturing Practices (GMP) regulations require that:

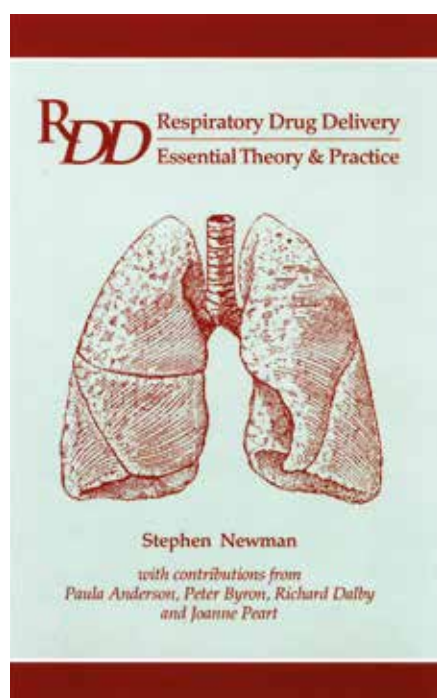

- a) The test methods used to monitor pharmaceuticals must meet proper standards of accuracy and reliability
- b) Companies should establish procedures to ensure the fitness for use of instruments that generate data supporting product testing

However, these GMP regulations do not provide definitive guidance as to how these aims are to be achieved.

The United States Pharmacopeia (USP) has sought to address this problem by the introduction of a series of chapters as follows:

- <1058> Analytical Instrument Qualification**
- <1225> Validation of Compendia Procedures**
- <1226> Verification of Compendia Procedures**

It is interesting to note that, hitherto, the scientific community has used the terms “validation” and “qualification” on an interchangeable basis thus creating a degree of ambiguity as to their use.

For this reason, USP have suggested that:

- a) The term “qualification” be applied to instrumentation
- b) The term “validation” be applied to processes and software

Hence the term “**Analytical Instrument Qualification**” (AIQ) is used for ensuring that an instrument is suitable for its intended application, and the term “**Analytical Method Validation (AMV)**” is used for ensuring that the analytical and software procedures employed are suitable for their intended application.

The USP Chapter <1058> Analytical Instrument Qualification describes in detail the four phase approach to qualification based on design (DQ), installation (IQ), operational (OQ) and performance (PQ) qualification.

It is important to note that the purpose of AIQ and its counterpart, AMV, is to ensure the quality of analysis before conducting the test, whereas **system suitability tests** and **quality control checks** ensure the quality of analytical results immediately before or during sample analysis.

Copley recognises the regulatory importance of these initiatives. The following pages describe a selection of products, services and documentation designed to guide and assist you through the regulatory process as applicable to inhaled products.

Impactor Testing - Possible Sources of Error



↑ Qualification Documentation

The performance of cascade impactors and the methods associated with them can be influenced by factors other than the impactor itself.

Nevertheless, in broad terms, most of the errors identified in APSD testing emanate from two sources:

- Analytical (human error)
- Instrument (errors in instrument and/or ancillary equipment)

If these sources of error can be eliminated then it is fair to assume that any anomalies in results are a product of the device/ formulation combination itself.

These analytical and instrument factors have been systematically reviewed by the PQRI (see Page 18) Particle Size Distribution Mass Balance Working Group in an article entitled "Considerations for the Development and Practice of Cascade Impaction Testing including a Mass Balance Failure Investigation Tree", *J.Aerosol.Med.*, 2003; 16(3):235-247.

ANALYTICAL ERRORS

Analytical (human) errors can be largely eliminated by the implementation of robust documented policies and validated procedures specific to the product, apparatus and test method concerned.

INSTRUMENT-RELATED ERRORS

Instrument-related errors can also be controlled in a similar manner by using (a) properly qualified instrumentation and (b) validated analytical procedures to use them.

PQRI list the following impactor related issues as potential causes of error in the day-to-day measurement of particle size distributions:

1. Instrument Qualification

- Instrument not qualified prior to or during use
- Inter-stage losses (in excess of 5%)
- Inadequate cleaning between tests
- Worn/corroded/clogged nozzles
- Improper sample recovery

2. Impactor Assembly

- All collection plates or cups present
- All collection plates or cups in the correct order
- All collection plates or cups seated correctly
- Final filter present and located correctly
- Inappropriate liquid levels (MSLI pre-separators)

3. Air Leaks into System:

- Air leaking into impactor caused by faulty inter-stage seals
- Poor seal between induction port preseparator/impactor interfaces
- Improper seal between inhaler mouthpiece and induction port

4. Collection Surface Preparation

- Scratched, bent or dented cups or plates
- Particle bounce and re-entrainment
- Problems in coating collection surfaces (ACI, NGI, etc.)
- Ensuring collection surfaces are moist (MSLI)

5. Flow-Related Factors

- Correct flow rate setting at the entry to the apparatus
- Failure to understand flow measurements and correction factors
- Incorrect flow rate setting
- Incorrect timer operation of solenoid valve

6. Inhaler Actuations

- Correct orientation and actuation of device
- Insufficient or excessive number of inhalations

7. Environmental Factors

- Barometric pressure (failure to account for)
- Temperature and humidity (failure to account for)
- Electrostatic effects

8. Other Factors

- Avoidance of premature deposition from DPIs by reducing the sample volume below the 4 Litre limit recommended in the compendia

Impactor Qualification

PHARMACOPOEIAL CRITERIA

Both the European and US Pharmacopoeias lay down certain criteria which the cascade impaction system and technique selected for the inhaler must fulfil prior to and during use.

1. Stage Mensuration

The performance and reproducibility of a cascade impactor are dependent on a number of factors, the most critical being the nozzle dimensions (and their spatial arrangement) on each stage together with the air flow rate passing through it.

Providing these critical dimensions are within the quoted specification, then the impactors concerned can be expected to give comparable results.

The process of measuring the nozzle diameters and other critical dimensions of cascade impactors is called stage mensuration.

Both Ph.Eur. and USP recommend the stage mensuration of impactors prior to use and periodically thereafter.

2. Re-entrainment

Particle bounce and re-entrainment can be a particular problem with DPIs and certain MDIs where measurements are based on a limited number of actuations from the inhaler.

Bounce and re-entrainment may be minimised by coating each collection surface with glycerol, silicone oil or similar high viscosity liquid typically deposited from a volatile solvent (see Page 116).

Plate coating must be part of method validation and may be omitted where justified and authorised.

3. Mass Balance

Mass Balance (MB) may be defined as “the sum of the amounts of Active Pharmaceutical Ingredient (API) collected from all stages of a cascade impactor including the induction port and preseparator (if used) as a % of target delivery per actuation”.

The Ph.Eur. state that the total mass of active ingredient should not be less than 75% and not more than 125% of the average delivered dose during testing for uniformity

of delivered dose. The FDA recommends that the mean amount of active ingredient be between 85 and 115% of label claim on a per actuation basis.

MB by itself should not be used as a system suitability test since it is still possible to obtain erroneous APSD results, owing to other factors even though the MB meets the compendia criteria concerned. Rather, an MB within expected limits merely indicates that the inhaler collected the expected mass of drug and should be used as just one more diagnostic tool to assess the validity of aerodynamic particle size distribution (APSD) data.

4. Inter-Stage Drug Loss (Wall Losses)

In addition to the criteria common to both Pharmacopoeias, above, USP also states that not more than 5% of the inhaler's total delivered drug mass into the impactor is subject to inter-stage losses.

If the losses are known to be greater than 5% then those losses should be included with the associated collection plate, or an alternative type of impactor used. In practice, it is often impossible to apportion such losses to individual stages therefore the latter approach is preferable.



↑ Mensuration Certificate

↓ Mensuration of ACI Stages using the Mitutoyo QV404 Vision Inspection System

Stage Mensuration

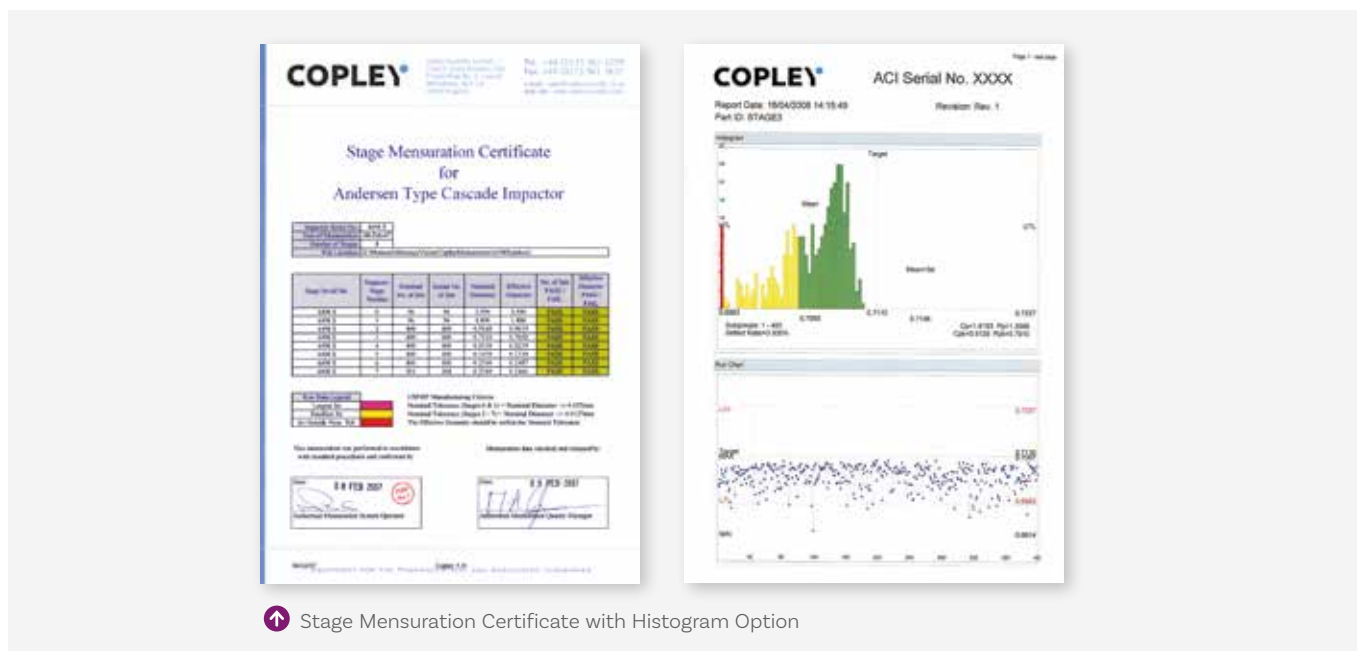

↑ Stage Mensuration Certificate with Histogram Option

INTRODUCTION

The performance and reproducibility of a cascade impactor is dependent on a number of factors, the most critical being the nozzle dimensions and their spatial arrangement.

In practice, cascade impactors often corrode and wear with use owing to their repeated exposure to formulations and recovery solvents. This is particularly true of aluminium impactors.

This can lead to full or partial nozzle occlusions causing changes in the impactor aerodynamics and hence particle collection characteristics.

The process of measuring stage nozzle diameters and other critical dimensions, known as stage mensuration, is used to ensure that cascade impactors conform to the critical dimensions stated in USP Chapter <601> and Ph.Eur. Chapter 2.9.18 and are therefore fit for use.

Stage mensuration replaces the need for repetitive calibration using standardised aerosols.

Copley provides a one-stop, quick turn-around mensuration service for all types of Ph.Eur. and USP specified impactors, including induction ports and preseparators.

Mensuration certificates are supplied as standard with all new impactors, preseparators and induction ports, detailing

how each component conforms to the pharmacopoeial requirements.

As impactors and ancillaries are put into use, regular re-mensurations (at least annually) should be performed to monitor and confirm their “in-use” compliance.

MENSURATION

To ensure high levels of reproducibility between measurements, Copley utilises a **Mitutoyo QV404 Automated Vision Inspection System** for optical inspection of impactor nozzles.

The same system is also used by our distributors in the USA. This ensures that any impactor, whether ACI or NGI, is mensurated using the same system and mensuration parameters in Europe and the USA.

Mitutoyo is widely acknowledged to be a world leader in vision measuring systems. Fully automatic, this non-invasive optical system sets the benchmark for measurement precision.

The QV404 features auto-focus, automatic stage illumination and dual measurement principles (edge detection and illuminated pixel count). This combination results in an unprecedented optical precision of <1 micron in comparison with the approx. 5 microns typically quoted by other systems.

Copley’s QV404 is verified daily using a National Physical Laboratory (NPL) glass

reticle containing nominal hole sizes covering every hole size of the ACI and NGI (down to 0.206 mm), and is calibrated annually to UKAS traceable standards (UKAS Laboratory 0332). This is preferable to the ring gauges, used by other providers, since these typically only go down to 1 mm diameter, which means that approximately 75% of the nozzles measured by the system fall outside its calibrated range.

A Mitutoyo Co-ordinate Measuring Machine (CMM) and Surface Roughness Measurement System are also used and are calibrated to national standards for the measurement of other critical components.

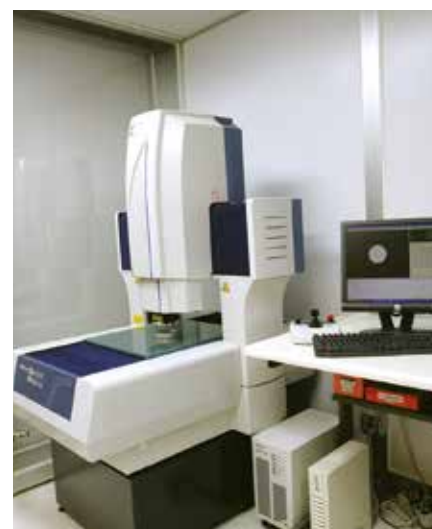

↑ QV404 Vision Inspection System (USA)

Stage Mensuration

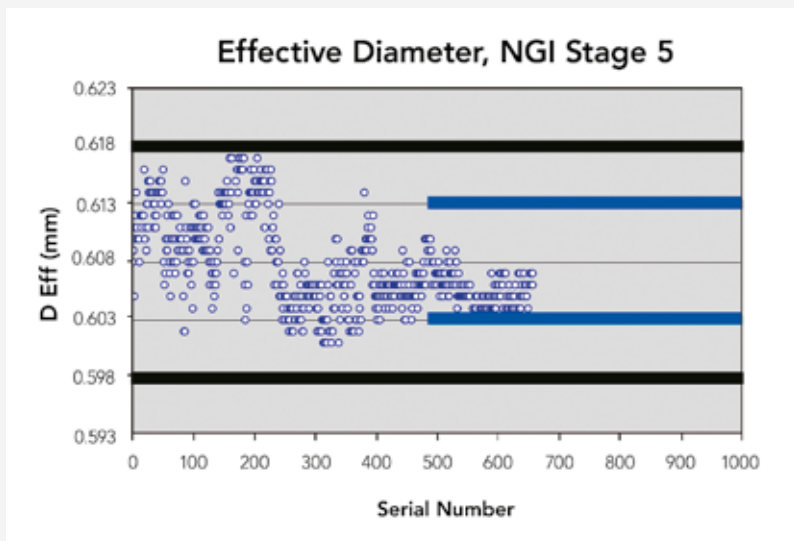

Stage Mensuration of NGI Nozzles using the Mitutoyo QV404 Vision Inspection System

CLEANING

Excessive accumulation of deposits in stage nozzles can affect particle size distribution measurements.

For this reason, all cascade impactors should be cleaned (see Pages 122-123) and, if necessary, pinned (see Page 137) on a regular basis to avoid build-up of unwanted debris.

The fully automated **Ultrasonic Cleaning System** used by Copley for cleaning, rinsing and drying both newly manufactured and used impactors prior to mensuration, was specifically designed and commissioned for this purpose.

This is a unique service included in the mensuration process and ensures that any transient surface debris is removed prior to mensuration.

It incorporates a 5-stage process:

1. Coarse clean ultrasonic bath (new impactors only)
2. Fine clean ultrasonic bath
3. Pre-rinse bath with air agitation
4. Rinse with de-ionised water
5. Dryer

An x-y-z robot, in conjunction with special carrying racks incorporating purpose built fixtures, is used to transport the impactor parts from station to station (see picture right).

INTERPRETATION OF DATA

The correct interpretation of mensuration data is the key to understanding the importance of impactor performance.

Copley adopts “**Effective Diameter**” and “**In-use Margin**” as recognised by the European Pharmaceutical Aerosol Group (EPAG) as a means of determining the suitability of cascade impactors for use. Additional graphical and statistical information from individual stages is also available as an option in the form of a histogram (see Page 135).

Derived from the area-mean and area-median diameters of multi-nozzle impactor stages, Effective Diameter (ED) is a useful parameter that can be used to monitor “drift” in impactor stage D50s.

The In-Use Margin is calculated as the % of USP/Ph.Eur. tolerance that remains relative to the ED. If the ED is equal to the stage nominal diameter then the In-Use Margin would be 100%. If, however, the ED is equal to the upper or lower USP/Ph.Eur. tolerance then the In-Use Margin would be 0%.

It follows that if the ED falls outside the compendia tolerance then the In-Use Margin would be a negative value.

Successive mensuration reports allow the tracking and monitoring of any deterioration of In-Use Margin, a useful way of investigating how an impactor is wearing

with time. This approach allows the likelihood of an **out-of-specification (OOS)** stage occurring within the next calibration cycle to be predicted, indicating when remedial work will be required.

Such data can provide interesting insight. The graph above, for example, shows the effects of improvements in the NGI manufacturing processes relating to Stage 5 of the NGI with serial number.

Every nozzle on the NGI has always met pharmacopoeial specifications (heavy black lines, above). Now though, with the improvements, every NGI has an ED within just half the range of the pharmacopoeial specification (heavy blue lines, above). These data therefore provide evidence of our commitment to constant quality improvement.



X-Y-Z Robot Ultrasonic Cleaning System

Stage Mensuration



↑ Pinning various stages of the ACI



↑ Pinning Kit with close-up of Pin

RESTORING IMPACTOR PERFORMANCE

If stage mensuration results in an ED in excess of an upper limit, then the stage must be replaced. This is a sign that the nozzles have worn, either as a result of corrosion from the solvents used to dissolve the active drug or erosion from the constant passage of particles through the nozzles concerned. In this case there is no alternative option available as it is not practical to reapply metal to impactor nozzles.

This situation is, however, rare, as the vast majority of impactors tend to drift out of specification because ED decreases below the lower limit for the stage.

This can be caused by a build-up of hardened particulates or, more likely, because the corrosion process produces metal salts that occlude the nozzle. The formation of oxidised impurities at the nozzle exit is a commonly encountered cause of occlusion, particularly for aluminium impactors, which is why materials such as stainless steel and titanium are often also used.

If the ED is too small, performance can sometimes be improved or restored. Ultrasonics (see Page 123) can be used to clean all impactors prior to mensuration. A combination of this and other rigorous cleaning is often sufficient to remove deposits and restore performance.

Otherwise, stage pinning is a secondary option. Pushing stainless steel “go” pins with a diameter between the nominal diameter and the lower tolerance limit for the stage through each nozzle can serve to clear accumulated debris.

Extreme care should be exercised in performing this function to avoid nozzle damage, particularly for aluminium impactors.

The pins are precision manufactured in a range of sizes corresponding to the

nozzle dimensions of the impactor stages concerned. For each stage, there are two pin diameters provided, one pin having a slightly smaller diameter than the other. The smaller diameter pin in each case can be used as an initial probe in cases, for example, where the holes in the stage are heavily occluded and the larger pin cannot be inserted into the nozzle. In this instance, the pinning becomes a two-stage process.

The pins are supplied in wooden boxes. Small pins are supplied in protective tubes with sealing corks. **The ACI Pinning Kit** is supplied with 14 pins, 2 pins to each of the 7 stages concerned.

The NGI Pinning Kit is supplied with 12 pins commensurate with Stages 1 to 6. In the case of Stage 7, it is not practical to use a pin due to the small size of the nozzles. A special brush with fine bristles is supplied instead.

Cat. No. Description

Impactor Mensuration Services

8590	Induction Port Mensuration
8390	ACI Stage Mensuration
8990	60 L/min Conversion Kit Mensuration
5236	90 L/min Conversion Kit Mensuration
8490	ACI Preseparator Mensuration
8311	ACI Stage Mensuration Histogram (per stage)
8890	MSLI Stage Mensuration and Leak Test
5290	NGI Stage Mensuration
5291	NGI Preseparator Mensuration
8312	NGI Stage Mensuration Histogram (per stage)
8591	Alberta Idealised Throat Mensuration
8340	FSA Stage Mensuration
5270	FSI Insert Mensuration
8917	GTI Mensuration

Mensuration 'Returns' Boxes

8391	ACI Mensuration 'Returns' Box
5292	NGI Seal Body Mensuration 'Returns' Box

Pinning Kits and Services

5430	ACI Pinning Service (per stage)
5431	ACI Pinning Kit
5432	NGI Pinning Service (per stage)
5433	NGI Pinning Kit

Qualification Documentation

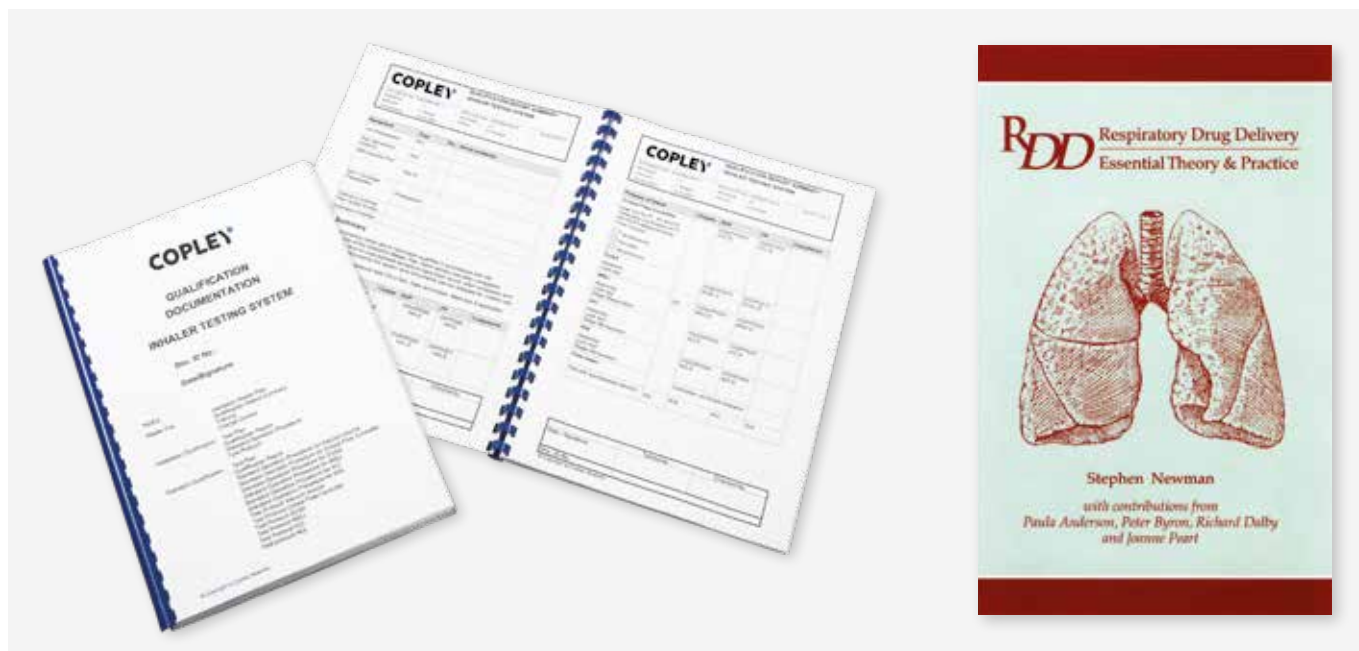

IQ/OQ DOCUMENTATION

According to USP Chapter <1058>, **Analytical Instrument Qualification** is “the collection of documented evidence that an instrument performs suitably for its intended purpose”

It is important to note that the stage mensuration process described on previous pages is intended to replace the need for repetitive impactor calibration based on standard aerosols. It ensures that only impactors that conform to specification are used in testing.

Whilst mensuration or calibration is an important part of the qualification process, it does not in itself qualify the whole inhaler testing system for use. This is a separate process.

The Installation Qualification/Operation Qualification Documentation (IQ/OQ) Documentation provided by Copley guides the user through this important process and confirms that the system is fully qualified for use.

DESCRIPTION

The IQ/OQ Documentation is written to GxP standards and is designed for qualifying the complete test system including the test apparatus (e.g. DUSA or cascade impactor), vacuum pump, critical flow controller (where applicable), flow meter and/or any other accessories that form part of an inhaler testing system.

The IQ/OQ Documentation is divided into three chapters:

1. The Master Plan

The purpose of the Master Plan is to define the aim and scope of the qualification.

The first section of the Master Plan describes in detail the various constituents that normally make up an inhaler testing system and provides an analysis of the likely risks associated with the parameters required to test them. It goes on to describe the various responsibilities assigned to the various parties undertaking the qualification, the qualification concept and the documentation structure to be used during the qualification work.

The second section comprises the Qualification Report Summary which gives details and a summary of the test results together with a list of users trained in the system use.

2. Installation Qualification

This Section outlines the test plan, the standard operating procedures and test protocols necessary to perform the IQ for the system concerned. It includes a general description of the system, delivery check, utilities/facility/environmental factors, system installation and verification.

3. Operation Qualification

This Section outlines the test plan and the standard operation procedures and test protocols to perform the OQ of the system concerned. It includes the information necessary to carry out both fixed parameter and functionality testing of the system.

Cat. No.	Description
8000	IQ/OQ Documentation for Inhaler Testing Systems
9500	Respiratory Drug Delivery Essential Theory & Practice Book



Qualification Tools

LEAK TESTING

The seals on cascade impactors can deteriorate with repeated use and exposure to solvent.

Leaks then occur which, because the system operates under vacuum, allows air into the system causing erroneous results due to incorrect flow rates and poor aerodynamic performance.

For this reason, all cascade impactors should be tested on a regular basis to check the integrity of the sealing system.

The most common method used for leak testing is to block the entry to the impactor inlet, generate a vacuum within the impactor using a vacuum source and then monitor any rise in pressure using a pressure meter located within the enclosed system.

This method is sensitive, accurate, straightforward and fast. It is ideal for verification checks during the life of the impactor or, indeed, as a fast system suitability test before an impactor is used.

The **Leak Test Kit Model LTK2** employs a separate vacuum source and can be used for vacuum levels up to 15 kPa below atmosphere for the ACI and MSLL.

The **NGI Leak Tester** incorporates its own syringe as the vacuum source and is designed for use with vacuum levels up to 5 kPa below atmosphere, as required for NGI leak testing.

QUALIFICATION KIT

The **Inhaler Testing Qualification Kit Model ITQK2** includes all the tools required to perform the IQ/OQ Qualification procedures (see Page 138) and can also be used for the calibration of the Critical Flow Controller Model TPK 2100/-R.

It includes all the tools in the Leak Test Kit Model LTK2, plus additional tools required to carry out in-house qualification of the inhaler testing system as a whole, supplied in a carrying case with all the necessary calibration certificates.

IMPACTOR PERFORMANCE

The Pharmacopoeias recommend stage mensuration at regular intervals to ensure that only impactors within specification are used for testing inhaler output.



↑ Impactor Leak Test Kit Model LTK2 (left) and NGI Leak Tester (above)

Unfortunately, because of the instrumentation, skill and time required to conduct a test, it is not practical to use stage mensuration on, for example, a daily basis. Currently therefore, there is no practical means of checking the system suitability of an impactor on a daily or individual test basis.

Nozzle dimensional performance can, however, be indirectly monitored by measuring the pressure drop (Delta-P) across

each stage of the impactor at a particular flow rate. Theoretically, for example, a 2% shift in ECD corresponds to an approximate 5% shift in Delta-P.

Delta-P can be measured by the addition of a pressure port at each stage. In the case of the NGI, this is achieved by means of a specially designed lid (see "Delta-P" Apparatus below). It is then a simple matter to determine the pressure drop across each stage using a sensitive pressure meter.

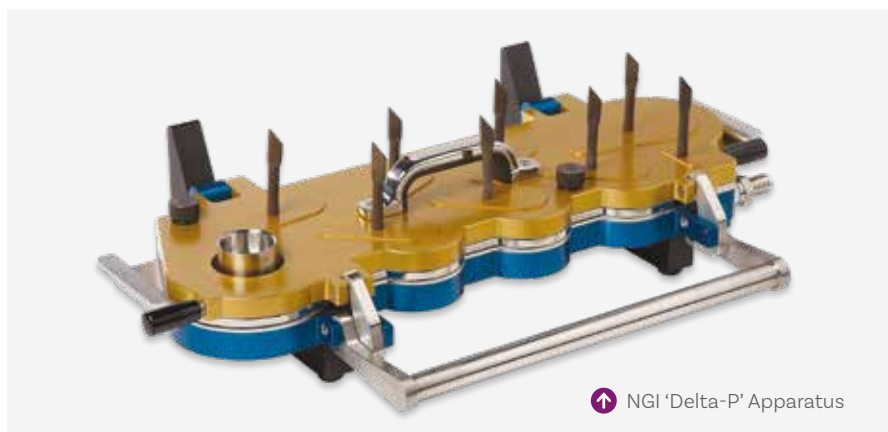

↑ NGI 'Delta-P' Apparatus

Cat. No. Description

5438	Impactor Leak Test Kit Model LTK2
5440	Inhaler Testing Qualification Kit Model ITQK2
5439	Additional Tools to upgrade LTK2 to ITQK2
5443	Re-calibration of Additional Tools
5207	NGI Leak Tester
5216	'Delta-P' Apparatus for NGI

Qualification Tools



↑ Inhaler Testing Qualification Kit Model ITQK2

↑ Digital Static Meter

↑ Electrostatic Eliminator

QUALIFICATION SERVICES

Leak test and Delta -P data can also be provided as an addition to our normal mensuration service. Many users take advantage of this service and incorporate the resulting data together with the mensuration data into their performance qualification files, to determine the impactor's continuing suitability for its intended use.

Such data is particularly relevant if a stage or MOC has been replaced as a result of the mensuration process.

We are also able to offer a Cut-Point Particle Calibration Service for individual impactors based on the use of standard aerosols. This is achieved by passing standardised particles, of known dimensions, through the impactor at a precisely controlled flow rate. The deposition of such particles within the impactor is then measured to determine the effective cut-off diameters applicable to each stage.

Whilst mensuration replaces the need for repetitive calibration using standard aerosols, cut-point calibration may be of interest where specific cut-points are required at flow rates that are less commonly used or specified by the manufacturer.

ELECTROSTATIC EFFECTS

The build-up of static electricity on plastic, non-conductive surfaces such as those found in inhaler actuators and/or spacers can present specific problems when working with inhalers, particularly dry powder devices.

Generally speaking, metal objects such as impactors do not present such a problem. Indeed, most problems of this nature emanate from the movement of the analyst around the laboratory prior to handling static sensitive equipment.

These problems can be exacerbated by the low humidity levels often found in air conditioned laboratories (<40% relative humidity) and also if the analyst is seated on a stool/chair and thereby isolated from the ground.

Irrespective of the source, it is preferable to take action to reduce static to a minimum on the grounds that it is one less variable capable of affecting the results.

The **Antistatic Grounding Kit** comprises a user wrist-band and bench mat, both grounded through the earth of an electrical socket. This dissipates any static when

handling the impactor/inhaler and all parts coming into contact with the laboratory bench during preparation.

The **Electrostatic Eliminator** is an efficient ioniser with variable speed fan and wide angle diffuser capable of eliminating static over a lab bench area of 2 m x 0.6 m.

A **Digital Static Meter** is also available which shows both intensity and polarity of static charge in the range 0 to +/- 20 kV. This is a useful tool for ensuring that the static levels around equipment are not excessive and are controlled.

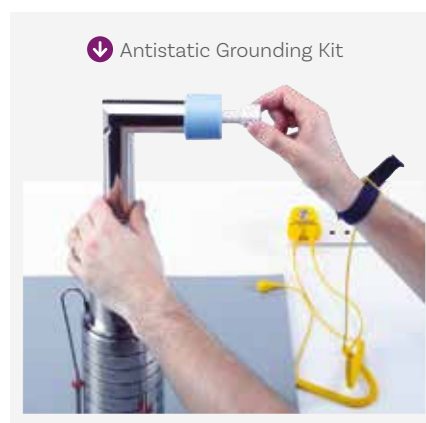

↓ Antistatic Grounding Kit

Cat. No. Description

5233	ACI or NGI Leak Test Certificate
5234	ACI or NGI Delta-P Certificate
5251	LTK or NGI Leak Tester Re-calibration Certificate
5442	ACI Cut-Point Particle Calibration Certificate
9300	Antistatic Grounding Kit
9301	Electrostatic Eliminator
9302	Digital Static Meter

Design & Servicing

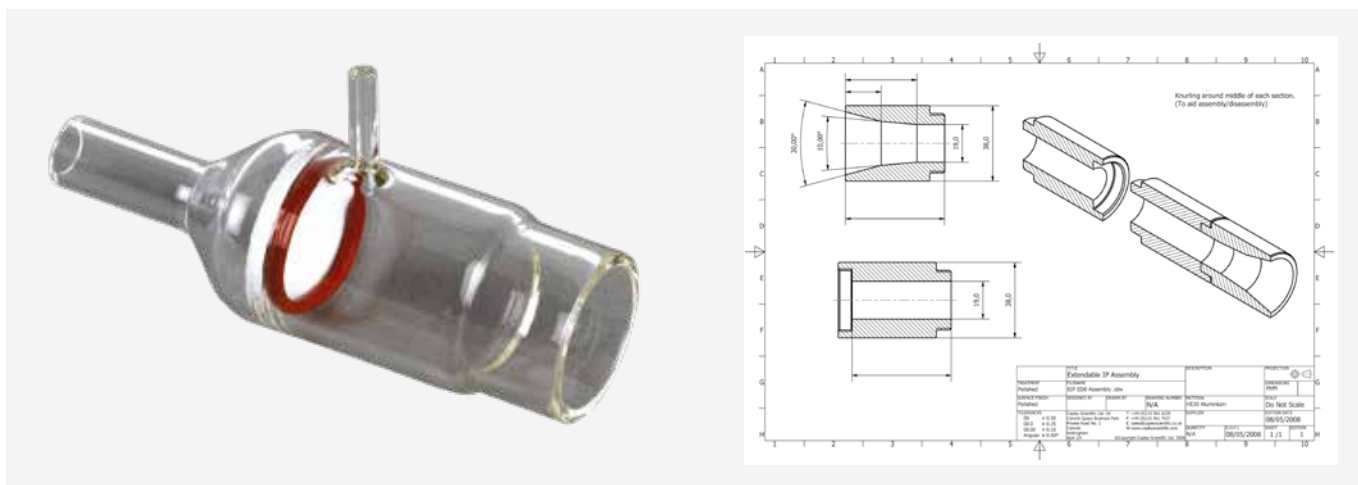

DESIGN

Our design team has many years' experience working closely with the inhaler testing community in helping to develop ideas for solving particular problems.

Whether you have a longstanding problem, or one that has been created by the introduction of a new process, an idea for a new product, or even a bespoke design that you need manufacturing, we would be delighted to hear from you.

SERVICING

Copley offers a comprehensive range of both in-house and on-site service contract options tailored to individual customers' needs and designed to provide quality maintenance and calibration procedures at competitive prices.

Contracts can be prepared for individual instruments or complete calibration management systems.

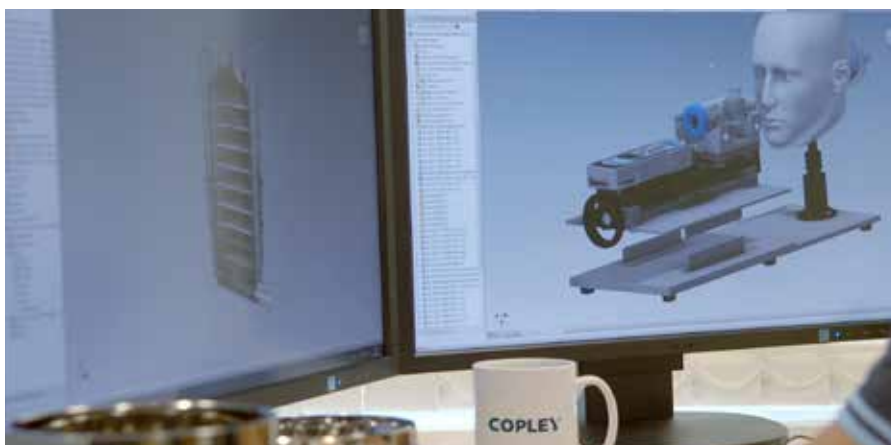

The creation of a typical service contract follows a structured format, which starts with determining the scope. This usually involves the customer supplying a detailed asset list of equipment requiring calibration, from which a proposal is made. This is reviewed by the customer and then if acceptable implemented, typically on an annual basis.

Our skilled engineers and technicians are trained to a high standard on the complete range of Copley and other related

products and fully understand all aspects of calibration and qualification (IQ/OQ/PQ) procedures from performance to document control and storage.

All documentation supplied conforms to GxP standards as required by the international regulatory authorities.

We will be pleased to discuss your individual requirements and quote accordingly.



Training

TRAINING

As a world leader in the provision of equipment for testing OINDPs, Copley offers a range of tailored training packages for both analysts and lab managers of pharmaceutical companies developing such products.

Training courses vary depending on existing levels of knowledge and can be conducted at Copley's training facility in Nottingham, UK, or at the customer's facility (in most cases).

Typical training programs include:

- Presentation on inhaler technology, test equipment, regulatory requirements, monographs and methodology, new industry developments, etc.
- Provision for the supply of technical papers and documents where appropriate
- Audit of current system set-up and procedures used (on-site training courses only)
- Training of users in operation of the equipment supplied
- Troubleshooting, Questions and Answers

Please feel free to contact us to discuss your requirements. We will be pleased to provide you with a quotation for a training program designed to meet your particular needs.





Book your bespoke training course at our state-of-the-art training facilities today.

- ✓ Highly experienced trainers
- ✓ Bespoke training programs
- ✓ On-site training available
- ✓ Certification provided



Please contact us to find out more about our range of training packages.

Contact us at: sales@copleyscientific.co.uk

or call: +44 (0)115 961 6229

Support

Buy with confidence from Copley. When you purchase equipment from us, you not only get outstanding instrumentation but also a complete customer care package which extends from the start of the sales process through to installation, training, after-

sales support and beyond. With a global network of experienced and knowledgeable distributors you can rest assured that, wherever you may be, there is support every step of the way.

A

Abbreviated Impactor Measurement (AIM)	62-67
ACI	43, 45-49
ACI Carrying/Wash Rack	48, 122
ACI, Cleaning	122-123
ACI Cleaning System	122-123
ACI Collection Plate Rack	49
ACI Drying Oven	122-123
ACI Leak Test Kit	139
ACI Pinning Kit	137
ACI Pinning Service	137
ACI Rinse Bath	122-123
ACI Sample Preparation Unit	120-121
ACI Suction Aspirator	123
ACI Ultrasonic Cleaning Bath	121-122
Active Pharmaceutical Ingredient (API)	14, 40-41, 62, 134
Active Substance Delivery Rate (Nebulisers)	32-33, 35
Actuation Sensor for MDIs	26, 56, 83, 85, 86
Adapters, Mouthpiece	41, 74, 90
Add-on Devices	8, 36-37, 40, 56, 87, 111
Aerodynamic Particle Size (APSD)	40-61
AIM - HRT Model	63, 64
AIM - QC Model	63, 64
Alberta Idealised Throat (AIT)	69, 70-71
Albuterol Aerosols, Testing	106, 109-110
Analytical Instrument Qualification (AIQ)	132, 138
Analytical Method Validation (AMV)	132
Ancillaries	74-100
Andersen Cascade/Impactor (ACI)	43, 45-49
Andersen Fast Screening Impactor (FSA)	65
Antistatic Grounding Kit	140
APSD	40-61
Aqueous Droplet Inhalers	7-9
Assistant, NGI	113, 130-131
Automated Fire	124-129
Automated Flow Control (Include TPK 2100/R)	84-85
Automated Nasal Testing System	127
Automated Shake	124-129

B

Automated Shake and Fire	124-129
Automation	113-131
Book, Reference	138
Breath Actuation Controller	26, 56, 74, 86-87
Breath-Actuated MDIs	8, 26, 86-87
Breath-Operated MDIs	26, 86-87
Breathing Simulators	33, 71, 74, 75-79
Bounce, Particle	42, 116, 133
BP Content Uniformity Apparatus	27

C

Caps, Rinsing	100
Carrying/Wash Rack, ACI	48, 122, 123
Carrying/Wash Rack, NGI	53, 122, 123
Cascade Impactors	41-42
CDER	13-14
CDRH	14
Chinese Pharmacopoeia (ChP)	13, 16, 17, 20, 23
CITDAS	94-99
Cleaning Systems, ACI/NGI	122 - 123, 136
Coarse Particle Mass (CPM)	64-67
Coating, Cups	116-117
Cold Freon® Effect	101, 111-112
Collection Tubes for DPIs	28-31, 114-115
Collection Tubes for MDIs	24, 25, 26, 27, 114-115
Connectors, Quick Release	100
Conversion Kits, 60 & 90 L/min	43, 49
Cooler, NGI	60-61
Counting Test	22
Critical Flow Controllers :	
- TPK-R	82-83
- TPK 2100/-R	84-85
Critical Quality Attributes (CQAs)	15, 16, 32, 79, 88
Critical (Sonic) Flow	80-87
Cup Coater	116-117
Cut-Off Diameter	42, 43, 46, 50, 54, 60, 63, 64, 65, 66-67, 72, 88
Cup Tray Storage Cabinet, NGI	118-119

D

Data Analysis Software (CITDAS)	94-99
DecaVertus	128-129
Delivered Dose Sampling Apparatus for:	
- Nebulisers with a Mouthpiece	32-33
- Nebulisers with a Facemask	34-35
- Spacers & VHCs	36, 39
Delivered Dose Uniformity (DDU)	21-39
Delta-P Testing	85, 139
Design	141
Design of Experiments (DoE)	79
Device Resistance	21, 80, 82, 100
DFM 2000 Flow Meter	88-89
DFM 4 Flow Meter	88-89
Dissolution Cup	105
Dissolution Inhaled	102-105
Dissolution Testing	
- Dose Collection	102-105
Dosage Unit Sampling Apparatus (DUSA) for DPIs	28-30, 114-115
Dosage Unit Sampling Apparatus (DUSA) for MDIs	24-27, 114-115
Drug Delivery Devices	7-11
Drug Losses, Inter-Stage	134
Drying Oven, ACI	122-123
Dry Powder Inhalers (DPIs)	9
DUSA Shaker	27, 30, 114-115

E

Effective Cut-off Diameter (ECD)	136
Effective Diameter	136
Efficient Data Analysis (EDA)	63
Electrostatic Effects	140
Electrostatic Eliminator	140
Emitted Dose	19, 24, 36, 38, 101, 102
Entire Dose	40-41, 62
Equipment Selection Guide	6
European Medicines Agency (EMA)	12, 13, 14, 17, 22, 23
European Pharmaceutical Aerosol Group (EPAG)	13, 18, 60, 136
European Pharmacopoeia (Ph.Eur.)	13, 16, 17, 20, 22
External Filter Holder, NGI	52, 53
Extra-fine Particle Mass (EPM)	64-66

F

Facemask-based products	34-35, 38-39
Facemask Stand for Nebulisers (FMS)	34-35
Facemask Test Apparatus for Spacers and VHCs (FMA)	38-39
Fast Screening Andersen (FSA)	65
Fast Screening Impactor (FSI)	67
Fast Screening Impactors	62-67
Fast Screening NGI (rNGI)	66
Fine Particle Dose (FPD)	42, 45, 58
Fine Particle Fraction (FPF)	42, 45
Fine Particle Mass (FPM)	20, 42, 64
Flow Meters	88-89
Flow Rate	80, 88-89
Flow Rate Stability	81
Flow Resistance	21, 28, 80
Fluticasone Propionate Aerosols - Testing	106-108
Fluticasone Propionate Powders - Testing	106-108
Food and Drug Administration (FDA)	12-14

G

Generic Drug Development	99, 106
Glass Expansion Chambers	58-59
Glass Impinger	55
Glass Twin Impinger	55
Gentle Rocker	118-119
Geometric Standard Deviation (GSD)	42, 45
Global Harmonisation Task Force (GHTF)	15
Gravimetric Cup, NGI	52, 53

H

Holding Chambers	8, 16, 36-39, 56-57, 78, 87
------------------	------------------------------------

I

ICH Guidelines	12, 15, 62
Idealised Throat	64, 69, 70-71, 137
Impactor Choice	43-44
Impactor Cleaning System	122-123, 136
Impactor Performance Testing	139
Impactor Qualification	134
Impactor Sized Mass (ISM)	63
Impinger, Glass, Twin	55

I

Inertial Impaction	42
Inhaled Drug Products	7-11
Inhaler Testing Software (CITDAS) Inlet, Mixing	94-99
Inspiration Volumes Installation	72-73
Qualification Internal Filter	21, 81
Holder, NGI	138
International Pharmaceutical Consortium on Regulation and Science (IPAC-RS)	53, 61
International Standards Organisation (ISO)	18
Inter-Stage Drug Losses	13, 18
Inter-stage Losses	134
<i>In vitro</i> - <i>in vivo</i> correlation	42, 134
In-use Margin	68-73
IPAC-RS	136
IQ/OQ Documentation	18
ISO 20072	138
ISO 27427:2013	13, 18
ISO 9001:2015 Quality Management System	18, 32
IVIVC Correlation	2
	68-73

J

Jet Nebulisers	10
----------------	-----------

L

Labour-Saving	113-131
Large Particle Mass (LPM)	63
Leak Test Kits	139
Losses, Inter-Stage	42, 134
Losses, Wall	134

M

Mass Balance	50, 134
MDI Actuation Sensor	26, 56, 83, 85, 86
MDI Angle of fire	124-129
MDI Angle of rotation	124-129
MDI Semi-Automation	124-129
MDI Shake control	124-129
MDI Spray actuation force control	124-129
Mensuration	135-137

M

Mesh Nebulisers	10
Meter, Flow	88-89
Meter, Static	140
Metered-Dose Inhalers (MDIs)	8
Metered Nasal Spray Pump	11
MHLW (Japan)	14
Mitutoyo QV404 Vision Inspection System	134-136
Mixing Inlet	72-73
Mouthpiece Adapters	41, 74, 90
Multi-Stage Liquid Impinger (MSLI)	44, 54

N

Nasal Delivery Systems	11, 58-59, 127
Nasal Sprays, APSD Testing	58-59
Nasal Spray Attachment, Twin Impinger	55
Nebulisers	10, 32-34, 60-61
Nebulisers, Delivered Dose	32-35
Nebulisers, Particle Size	60-61
Next Generation Impactor (NGI)	44, 50-53
NGI	44, 50-53
NGI Assistant	113, 130-131
NGI Carrying/Wash Rack	53, 122, 123
NGI Cooler	60-61
NGI Cup Coater	116-117
NGI Cup Tray Storage Cabinet	118-119
NGI Gentle Rocker	118-119
NGI Gravimetric Cup	52-53
NGI Leak Test Kit	139
NGI Pinning Kit	137
NGI Pinning Service	137
NGI, Reduced (rNGI)	66
NGI Sample Preparation Unit	120-121
Novi	124-129

O

OINDP Terminology	17
OINDPs	7-11
Operation Qualification	138
Organisations	12-18

P

P1 Measurement Adapter	100
Parametric Tolerance Interval Testing (PTIT)	22
Particle Bounce	42, 116, 133
Particle Size	20, 40
Pharmacopeial Forum	16, 17
Pharmacopoeial Specifications	19-20, 134
Pharmeuropa	16, 19-20
Ph.Eur.	16, 19-20
Pinning Kits	137
Pinning Service	137
Plume Temperature Testing	101, 112
Powder-Based Nasal Devices	11
Pressure Drop	80, 85, 139
Process Analytical Technologies (PAT)	12, 15, 40 62
Product Quality Research Institute (PQRI)	13, 18, 62
Propellant-Based Nasal Aerosols	11
PTIT	22
Pumps, Vacuum	91-93
PVC Tubing	100

Q

Qualification	132-140
Qualification Documentation	138
Qualification Service	140
Qualification Tool Kit	139, 140
Quality by Design (QbD)	12, 14, 15, 40, 62, 75, 79
Quality Control checks	132
Quick Clamp	47, 49, 59
Quick-Release Connectors	100

R

Reduced NGI (rNGI)	66
Re-entrainment	42, 54, 116, 134
Reference Books	138
Regulatory Bodies	14-18

Repetitive Strain Injury	113, 120
Resistance to Flow	21, 80, 82, 100
Reverse Firing Spacers	36
Rinsing Caps	100

S

Salmeterol Aerosols, Testing	101, 106, 107-108
Salmeterol Powders, Testing	101, 106, 107-108
Sample Preparation Unit	120-121
Servicing	141
Shake and Fire	124-129
Shaker, DUSA	27, 30, 114-115
Simulators, Breathing	33, 71, 74, 75-79
Small Particle Mass (SPM)	63
Soft Mist Inhalers	9
Software (CITDAS)	94-99
Sonic Flow	80-87
Spacers	8, 16, 36-39, 56-57, 78, 87
Spacers, APSD Testing	56-57, 87
Spacers, DDU Testing	36-39
Spray Force Tester	111
Spray Pattern	111
SPU Sample Preparation Unit	120-121
Stage Cleaning	122-123, 136
Stage Mensuration	135-137
Static Meter	140
Storage Cabinet, NGI Cup Tray	118-119
Suction Aspirator, ACI	122
System Suitability Tests	132
System Qualification	132-140

T

Target Delivered Dose (TDD)	22
Terminology, OINDPs	17
Throats, Idealised	64, 69, 70-71
Total Active Substance Delivered (Nebulisers)	32-33
TPK Critical Flow Controller	82-83
Training	142-143
Tubing	100
Twin Impinger, Glass	55

U

Ultrasonic Cleaning Bath, ACI	122-123
Ultrasonic Nebulisers	10
United States Pharmacopeia (USP)	16, 19

V

Vacuum Pumps	91-93
Validation	132
Valved Holding Chambers (VHCs)	8, 16, 36-39, 56-57, 78, 87
Verification	132
Vertus II	124-125
Vertus Plus	126
VHCs, APSD Testing	56-57, 78, 87
VHCs, DDU Testing	36-39, 87
Vision Inspection System, Mitutoyo QV 404	134-136
Volume, Inspiration	21, 81

W

Wall losses	134
Waste Shot Collector	31, 112, 124, 125, 126, 128-129
Wash Rack, ACI	48, 123
Wash Rack, NGI	53, 123
Watchglass/PTFE Assembly (Dissolution)	105
21 CFR Part 11	95, 125
60 L/min Conversion Kit	46
90 L/min Conversion Kit	46

COPLEY®

Архангельск (8182)63-90-72
Астана (7172)727-132
Астрахань (8512)99-46-04
Барнаул (3852)73-04-60
Белгород (4722)40-23-64
Брянск (4832)59-03-52
Владивосток (423)249-28-31
Волгоград (844)278-03-48
Вологда (8172)26-41-59
Воронеж (473)204-51-73
Екатеринбург (343)384-55-89
Иваново (4932)77-34-06

Ижевск (3412)26-03-58
Иркутск (395)279-98-46
Казань (843)206-01-48
Калининград (4012)72-03-81
Калуга (4842)92-23-67
Кемерово (3842)65-04-62
Киров (8332)68-02-04
Краснодар (861)203-40-90
Красноярск (391)204-63-61
Курск (4712)77-13-04
Липецк (4742)52-20-81
Киргизия (996)312-96-26-47

Магнитогорск (3519)55-03-13
Москва (495)268-04-70
Мурманск (8152)59-64-93
Набережные Челны (8552)20-53-41
Нижний Новгород (831)429-08-12
Новокузнецк (3843)20-46-81
Новосибирск (383)227-86-73
Омск (3812)21-46-40
Орел (4862)44-53-42
Оренбург (3532)37-68-04
Пенза (8412)22-31-16
Казахстан (772)734-952-31

Пермь (342)205-81-47
Ростов-на-Дону (863)308-18-15
Рязань (4912)46-61-64
Самара (846)206-03-16
Санкт-Петербург (812)309-46-40
Саратов (845)249-38-78
Севастополь (8692)22-31-93
Симферополь (3652)67-13-56
Смоленск (4812)29-41-54
Сочи (862)225-72-31
Ставрополь (8652)20-65-13
Таджикистан (992)427-82-92-69

Сургут (3462)77-98-35
Тверь (4822)63-31-35
Томск (3822)98-41-53
Тула (4872)74-02-29
Тюмень (3452)66-21-18
Ульяновск (8422)24-23-59
Уфа (347)229-48-12
Хабаровск (4212)92-98-04
Челябинск (351)202-03-61
Череповец (8202)49-02-64
Ярославль (4852)69-52-93

<https://tsi.nt-rt.ru> || tfs@nt-rt.ru